

Digital Drum Owner's Manual

INFORMATION FOR YOUR SAFETY!

THE FCC REGULATION WARNING (for USA)

This equipment has been tested and found to comply with the limits for a Class B digital device, pursuant to Part 15 of the FCC Rules.

These limits are designed to provide reasonable protection against harmful interference in a residential installation. This equipment generates, uses, and can radiate radio frequency energy and, if not installed and used in accordance with the instructions, may cause harmful interference to radio communications. However, there is no guarantee that interference will not occur in a particular installation. If this equipment does cause harmful interference to radio or television reception, which can be determined by turning the equipment off and on, the user is encouraged to try to correct the interference by one or more of the following measures:

- Reorient or relocate the receiving antenna.
- Increase the separation between the equipment and receiver.
- Connect the equipment into an outlet on a circuit different from that to which the receiver is connected.
- Consult the dealer or an experienced radio/TV technician for help.

Unauthorized changes or modification to this system can void the user's authority to operate this equipment.

CAUTION

The normal function of the product may be disturbed by Strong Electro Magnetic Interference. If so, simply reset the product to resume normal operation by following the owner's manual. In case the function could not resume, please use the product in other location.

PRECAUTIONS

PLEASE READ CAREFULLY BEFORE PROCEEDING

Please keep this manual in a safe place for future reference.

Power Supply

Please connect the designated AC adaptor to an AC outlet of the correct voltage.

Do not connect it to an AC outlet of voltage other than that for which your instrument is intended.

Unplug the AC power adaptor when not using the instrument, or during electrical storms.

Connections

Before connecting the instrument to other devices, turn off the power to all units. This will help prevent malfunction and / or damage to other devices.

Location

Do not expose the instrument to the following conditions to avoid deformation, discoloration, or more serious damage:

Direct sunlight
Extreme temperature or humidity
Excessive dusty or dirty location
Strong vibrations or shocks
Close to magnetic fields

Interference with other electrical devices

Radios and televisions placed nearby may experience reception interference. Operate this unit at a suitable distance from radios and televisions.

Cleaning

Clean only with a soft, dry cloth.
Do not use paint thinners, solvents, cleaning fluids, or chemical-impregnated wiping cloths.

Handling

Do not apply excessive force to the switches or controls.

Do not let paper, metallic, or other objects into the instrument. If this happens, remove the electric plug from the outlet. Then have the instrument inspected by qualified service personnel.

Disconnect all cables before moving the instrument.

Main Features	4	Recording	
Panel & Display Description		Prepare Recording.....	15
Front Panel.....	5	Start / Stop Recording.....	15
Side Panel (Connection).....	6	Coach Mode	
LCD Display.....	7	Coach Mode Control.....	16
Setup		Quiet Count.....	16
Connecting Pads and Pedals.....	8	Change Up.....	17
Getting Ready to Play		Beat Check.....	18
Setting Up Power Supply.....	9	DBT (Double Bass Trigger)	19
Turning the Power On/Off.....	9	Tempo	19
Adjusting the Head Tension.....	9	Utility Settings	
Auto Power Off.....	9	The Drum Pad Trigger Settings.....	20
Quick Play		The Drum Module Settings.....	21
Drum Kits and Voices.....	10	Troubleshooting	22
Playing Techniques.....	11	Prompt Messages	22
Drum Kit		Specifications	23
Preset Drum Kit and User Drum Kit.....	12	Appendix	
Editing Kit Parameters.....	12	Drum Kit List.....	23
Editing Voice Parameters.....	12	Drum Voice List	24
Saving User Drum Kit.....	13	Song List.....	27
Playing Along with a Song		GM Drum Kit List.....	28
Playing Along with a Song.....	14	GM Backing Instrument List.....	30
Muting the Drums in a Song.....	14	MIDI Implementation Chart.....	31
Click.....	14		

Main Features

Bring Natural and Realistic Voices to Your Performance

This digital drum has equipped with all new voices to provide a super natural and realistic sense for your ears. No matter playing stroke roll or striking pads with velocity dynamics, it lets you enjoy the delicate nuances and natural voices, replicating the unique characteristics of an acoustic drum kit.

Fashionable Appearance

With a compact and elegant design, this digital drum is the perfect partner for drum learning, and nicely fits your home decor.

Amazing DBT Function

The DBT (double bass trigger) function makes it easy to achieve the double bass technique. You may adjust the trigger interval to fit your performance.

Smart Coach Mode

Try the three coach modes with dozens of common beat practices, and track your progress with the smart score function.

USB MIDI Output

The USB MIDI output provides easy connection with a computer and smart device such as iPad (camera kit is required).

Front Panel

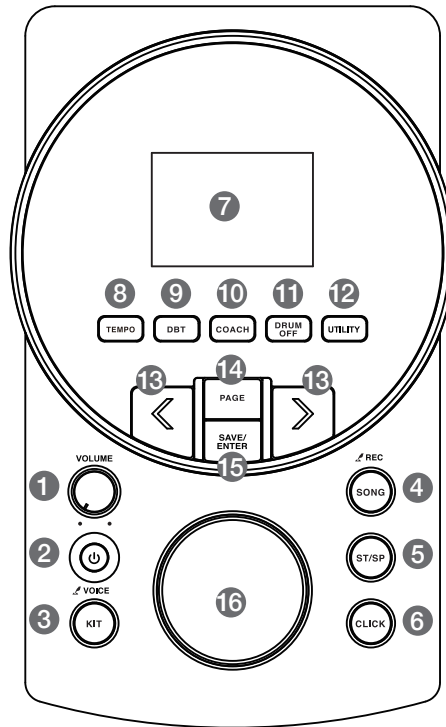

1. [VOLUME] Knob

Adjust the headphones volume level.

Note:

Rotate the [VOLUME] knob counter-clockwise to the minimum position before power on.

2. [POWER] Button

Press this button to turn the module on/off.

3. [KIT/VOICE] Button

Press this button to enter kit mode.
Long-press it to enter voice mode.

4. [SONG/REC] Button

Press this button to enter song mode.
Long-press it to enter record mode.

5. [START/STOP] Button

Start/stop playing songs.

6. [CLICK] Button

Start/stop the click function; enter the click setting mode.

7. LCD Display

Display the names and settings information.

8. [TEMPO] Button

Adjust the tempo value.

9. [DBT] (DOUBLE BASS TRIGGER) Button

Turn DBT function on/ off.

10. [COACH] Button

Enter coach mode.

11. [DRUM OFF] Button

Mute/unmute the drum part in a song.

12. [UTILITY] Button

Enter the utility setting mode.

13. [< / >] Button

Gradually set parameter values.

14. [PAGE] Button

Switch between the settings of a function.

15. [SAVE/ENTER] Button

Save the drum kit / pad settings.

16. DATA DIAL

Set parameter values.

Panel Description

Side Panel (Connection)

Note:

To prevent malfunction and equipment failure, always turn down the volume and turn off all the units before making any connection.

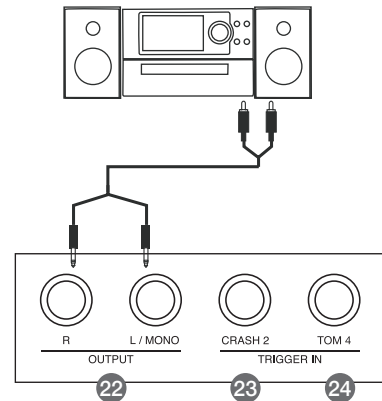
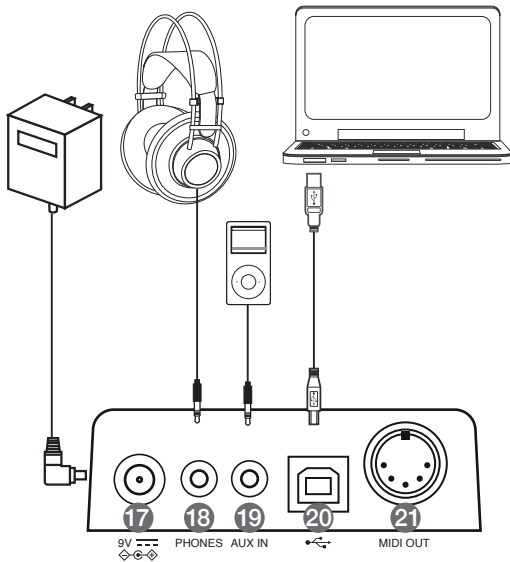

17. POWER jack

For connecting the specified power adapter.

18. PHONES jack (1/8")

For connecting a pair of headphones.

19. AUX IN jack (1/8")

For connecting external audio player, such as an MP3. You can enjoy playing the drum along with your favorite songs.

20. USB MIDI Terminal

For connecting to a computer.

Note: Only for transmitting MIDI data.

21. MIDI OUT Terminal

For transmitting MIDI data to external MIDI device.

22. OUTPUT jack (L/MONO, R) (2 x1/4")

For connecting an audio system or amplifier. For stereo output use both the L/MONO and R jacks. For monaural output use the L/MONO jack.

23. CRASH 2 jack (1/4")

For connecting additional Crash 2.

24. TOM 4 jack (1/4")

For connecting additional Tom 4.

LCD Display

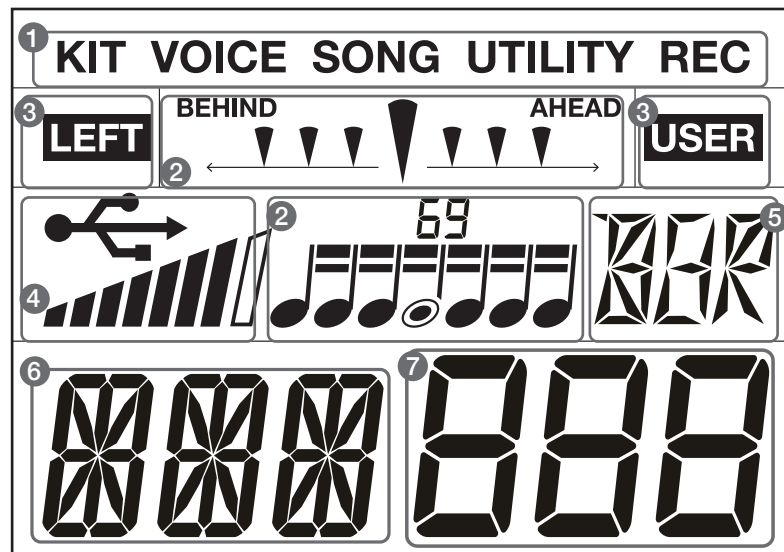

1. Mode

Display the current mode, such as KIT, VOICE, SONG, and UTILITY.

2. Coach Mode

Display current beat accuracy and rhythm type.

3. The Secondary Mode

Display the secondary mode of some primary modes.

4. External Device and Striking Strength

Display the connected external device and current striking strength.

5. Pad Name

Display the current selected pad name.

6. Parameter Name

Display current parameter name such as volume, curve.

7. Parameter Value

Display current parameter value or the number of Song/Kit/Voice.

Caution!

To prevent electric shock and damage to drum module or other devices, always turn off the power of all devices before making any connections.

Connecting Pads and Pedals

Standard configuration: Kick Pad, Kick Pedal, Snare (2-zone), Tom 1~3 (2-zone), Crash (with choke), Ride (2-zone with choke), Hi-hat, Pedal (Hi-hat).

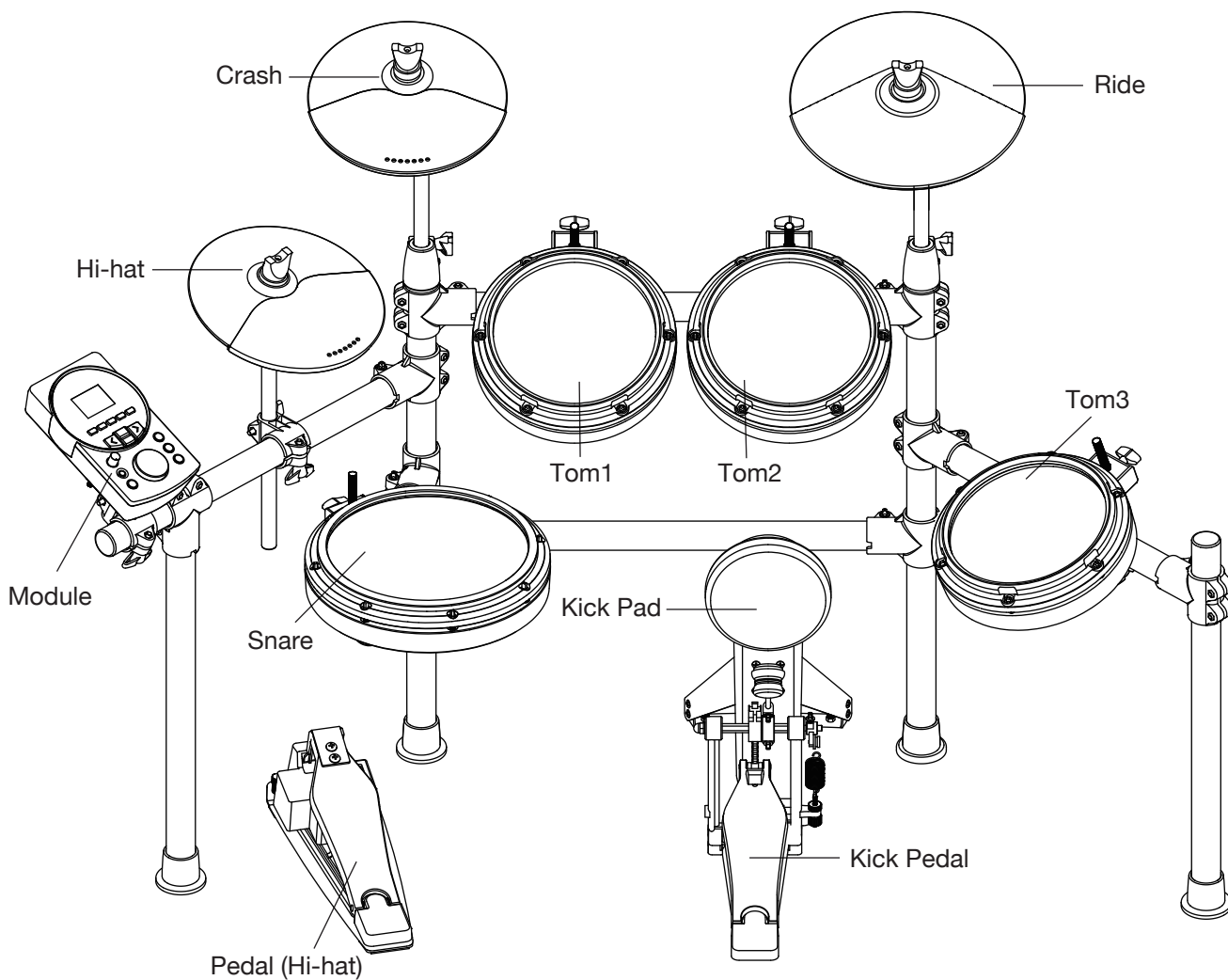

Notes:

1. Use the provided cables to connect the pads to the Trigger Input jack on the rear panel of the module. Make sure each pad is connected to its corresponding trigger input jack.
2. Refer to the **Setup Guide** for details on assembling the drum stand, attaching the drum pads and module.

Setting Up Power Supply

1. Connect the AC power adaptor to the Power jack on the side panel.
2. Connect the other end of the power cord to the AC outlet.

Notes:

1. Use only the specified AC adaptor.
2. Even when the module is turned off, electricity is still flowing to the module at minimum level. Please unplug the module when it is not in use for a long time.

Turning the Power On/Off

Turning On the Power

1. Make sure the master volume level is set to minimum.
2. Press the [POWER] button to turn on the module.
3. Listen to the headphones, and adjust the [VOLUME] knob while striking the pads until you get an appropriate volume level.



Note:

Before turning on the power, make sure you have completed all necessary connections (trigger, audio etc.) and turn down the volume of all the connected equipments.

Turning Off the Power

1. Set the volume level of the module and the connected audio device to minimum.
2. Turn off the connected audio device.
3. Press the [POWER] button to turn off the module.

Factory Reset

The module will automatically save current settings before it turns off. If you want to restore factory settings, please use the following procedure:

1. Press and hold the [<] and [>] buttons simultaneously, then press the [POWER] button to turn on the module.
2. The LCD will temporarily display “FAC SET” to indicate factory reset is finished.

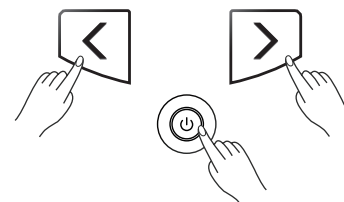

Adjusting the Head Tension

Please adjust the head tension before you start to perform. By adjusting the head tension, you may make the pad respond to your strikes, just like playing an acoustic drum.

1. Follow the order indicated in the image. Turn each tension bolt around the head little by little.
2. Adjust the tightness of each bolt to make the pad tension even.

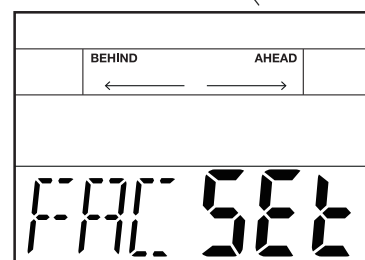

Notes:

1. Always adjust each tension bolt little by little. Turning the bolts too much in one step may result in uneven pad tension.
2. The head tension may change after using for some time. Adjust the head tension whenever it is necessary.

Auto Power Off

In order to save energy, the module will automatically turn off after 30 minutes if it is not in use. You may enable or disable this function in Utility Settings.

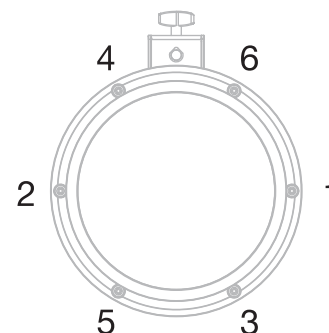

Quick Play

Drum Kits and Voices

An acoustic drum has only one fixed kit and it's unchangeable. A digital drum is preset with various voices of different styles. You may combine different voices and make as many drum kits as you like.

The structure of a drum kit is shown on the right:

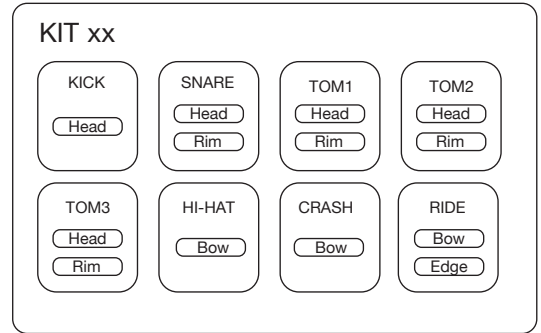

Selecting a Drum Kit

1. Press the [KIT] button to enter the kit menu.

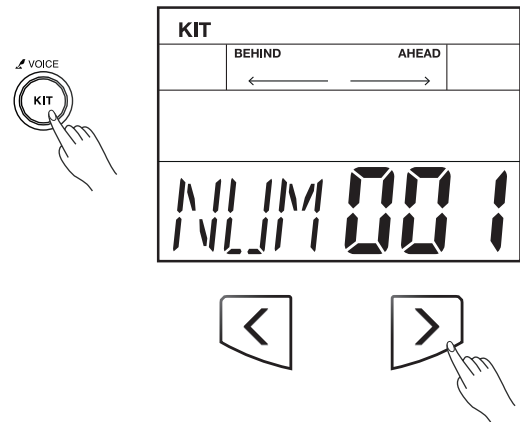

2. Press the [<]/[>] button or turn the [DIAL] to select your desired drum kit. (Refer to *Drum Kit List*)

Selecting a Voice

While striking the pads, you can enjoy the ensemble sound effect. If you are not satisfied with the voice of any pads, change the voice as you want.

1. Press the [KIT/ VOICE] button for 2 seconds to enter the voice menu.

2. Strike the pad that you want to edit.
The screen will display the name of current pad.

3. While striking the pad, press the [<]/[>] button or turn the [DIAL] to select a desired voice for the pad. (Refer to *Drum Voice List*)

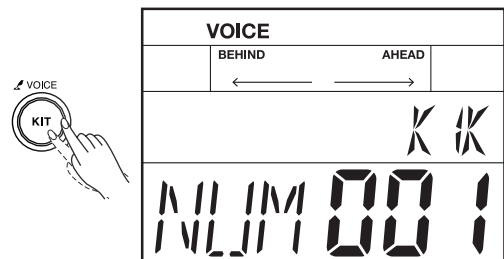

Playing Techniques

This section introduces various performance functions to make your performance professional. Similar to an acoustic drum kit, the digital drum responds differently to various playing techniques and dynamics. All the pads are velocity sensitive. And some voices change timbre depending on the striking force.

Pad

Only the snare drum can detect both head shot and rim shot.

Head Shot

Strike only the head of the pad.

Rim Shot

Strike the head and the rim of the pad simultaneously. Or only strike the rim of the pad.

Cymbal

Cymbal Bow shot

Strike the middle area of the cymbal.

Cymbal Edge Shot

Strike the edge area of the cymbal.

Choke Play

Both Ride and Crash cymbals have cymbal choke. But hi-hat don't support cymbal choke.

Choking the crash/ride edge with the hand immediately after hitting the crash/ride mutes the crash/ride sound.

Hi-Hat

Hi-Hat Pedal Change

Press the pedal down to different positions, the sound of striking the Hi-Hat cymbal will vary. And this is similar to an acoustic drum.

Open Hi-Hat

Strike the Hi-Hat pad without pressing the pedal.

Closed Hi-Hat

Strike the Hi-Hat pad with the pedal pressed completely down.

Hi-Hat Pedal

Press down the hi-hat controller's pedal to create a foot-close sound without having to strike the hi-hat pad.

Splash

Playing the hi-hat with the pedal fully pressed and then instantly opening it.

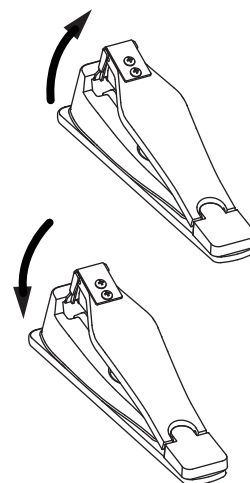
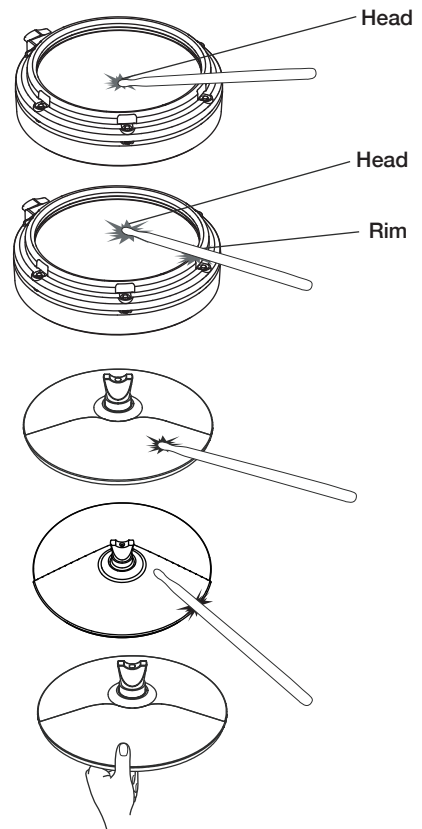

Drum Kit

Preset Drum Kit and User Drum Kit

The module features a variety of preset drum kits and several user drum kits. You can select your favorite drum kits and edit the parameters to fit your playing, then save the settings in user drum kits. (Refer to Drum Kit List).

Note:

Save your settings to a user drum kit after editing, otherwise, all edited data will be lost.

Editing Kit Parameters

Changing the kit parameter will affect all pads, which means when you increase the volume of a drum kit, the volume of all pads will be increased.

1. Press the [KIT] button, the LCD will display the kit menu.
2. Repeatedly press the [PAGE] button to select a parameter to edit.

Parameter	Value	LCD Display	Description
Kit No.	Preset: 1~30 User: 31~40	NUM XXX	Select a drum kit.
Volume	0~127	VOL XXX	Adjust the volume of drum kit; the volume of each pad will be changed.

3. Press the [</>] button or turn the [DIAL] to adjust parameter value.

Editing Voice Parameters

Edit parameters of one pad will not affect others. For example, if you increased the volume of snare, the other pads wouldn't change.

1. Press the [KIT/VOICE] button for 2 seconds and the LCD will display the voice menu.
2. Strike the pad that you want to edit.
3. Repeatedly press the [PAGE] button to select a parameter to edit.

Parameter	Value	LCD Display	Description	Triggers:
Voice No.	1~408	NUM XXX	Select a voice.	KIK (Kick) Sn (Snare) SnR (Snare Rim) T1 (Tom1) T1R (Tom1 Rim) T2 (Tom2) T2R (Tom2 Rim) T3 (Tom3) T3R (Tom3 Rim) T4 (Tom4) T4R (Tom4 Rim) HH (Hi-hat) C1 (Crash1) C2 (Crash2) Rd (Ride) RdR (Ride Edge) Pd (Hi-hat Pedal) PS (Hi-hat Splash)
Volume	0~127	VOL XXX	Adjust the volume of voice.	

4. Press the [</>] button or turn the [DIAL] to adjust parameter value.

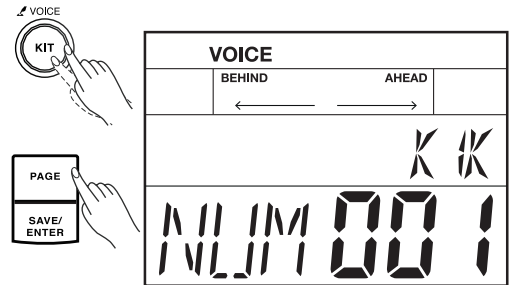
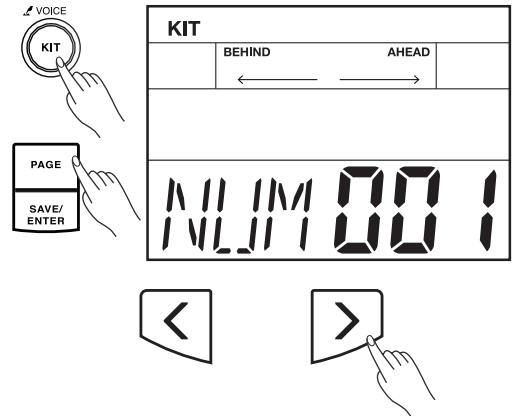

Saving User Drum Kit

1. While in the drum kit or voice edit menu, press the [SAVE/ ENTER] button to save all changes.

2. Use the [<]/[>] button or turn the [DIAL] to select a user drum kit. The user kit number will flash.

3. Press the [SAVE/ ENTER] button again; the LCD will display “OK”, which indicates all data has been saved successfully.

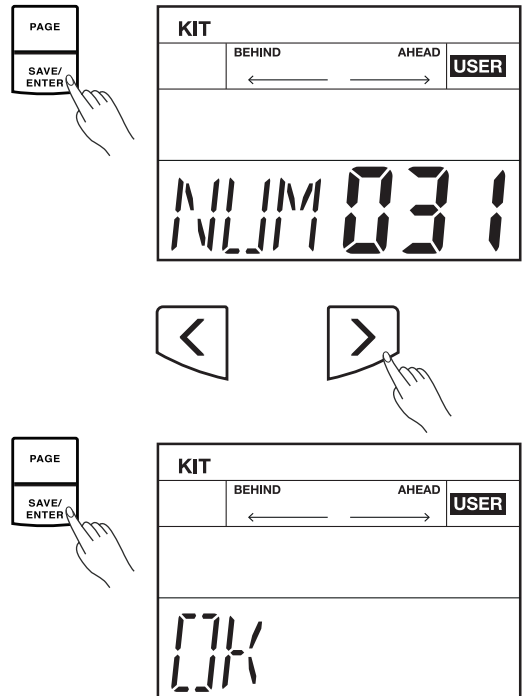

Playing Along with a Song

The module provides a variety of songs. (Refer to the *Song List*) You can play the drums while listening to one of these songs. A song contains Drum part and Accompaniment part. Drum part means the rhythm you played on the pads; the Accompaniment part means percussion and melody. The volume of each part can be adjusted.

Playing Along with a Song

1. Press the [SONG] button to enter the song menu.
2. Repeatedly press the [PAGE] button to select a parameter to edit.

Parameter	Value	LCD Display	Description
Song No.	1~85	NUM XXX	Select a song.
Accompaniment Volume	0~8	ACC XXX	Adjust the background volume.
Drum Volume	0~8	DRM XXX	Adjust the drum volume.

3. Use the [<|>] button or turn the [DIAL] to adjust the parameter value. Press the [<] and [>] buttons at the same time to mute/unmute the current part.
4. Press the [START/STOP] button to play/stop the song.

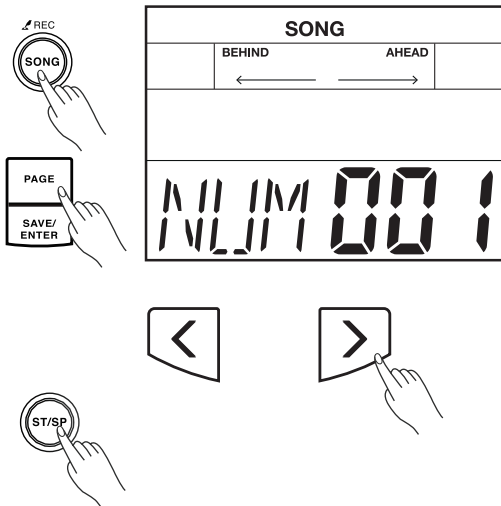

Muting the Drums in a Song

You can mute the drum part of a song and play along with the accompaniment part. Press the [DRUM OFF] button to mute the drum part, the button LED will be lit. Press this button again to unmute the drum part.

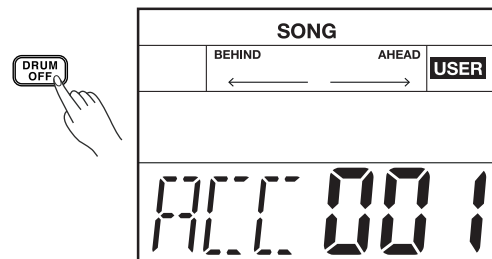

Click

The click helps you practice at a steady tempo. You may set the click parameters to fit your practice.

1. Press the [CLICK] button to start the click. The button indicator will blink along.
2. Repeatedly press the [PAGE] button to select a parameter to edit.

Parameter	Value	LCD Display	Description
Time Signature	0-9/2, 0-9/4, 0-9/8, 0-9/16	SIG XXX	Adjust the time signature.
Interval	1/2, 3/8, 1/4, 1/8, 1/12, 1/16	INT XXX	Adjust the rhythm interval.
Volume	0~5	VOL XXX	Adjust the click volume.
Voice	1~6	NUM XXX	Select the click voice.

3. Use the [<|>] button or turn the [DIAL] to change the parameter value.
4. Press the [CLICK] button again to stop the click. The button indicator will be off.

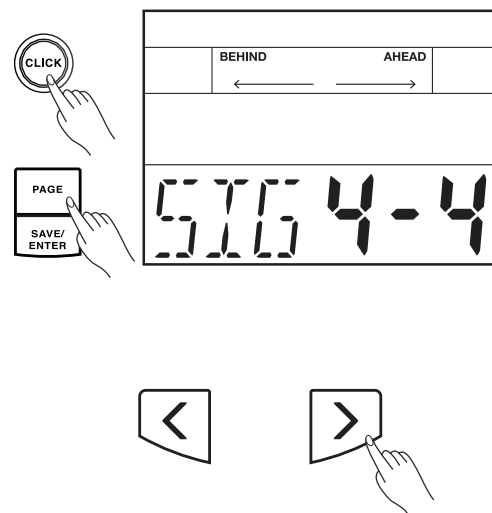

You may record your performance and save it as a user song. You can record up to 2500 notes in each user song.

Prepare recording

1. Press the [SONG/REC] button for 2 seconds to enter the Record-prepare mode, the light of the [SONG/REC] button start flashing. Use the [<]/[>] button or turn the [DIAL] to select a user song to save the recording.
2. Press the [START/STOP] button, the LCD displays “RDY---”. It means recording is on standby. If you want to exit the record mode, press the [SONG]/[KIT] button.

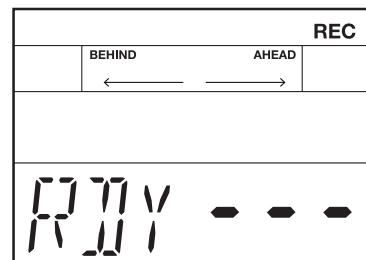

Start / Stop Recording

1. When recording is on standby, you can start recording in one of these two ways:
 - Press the [START/STOP] button.
 - Strike one pad.
2. Recording begins after 4 beats count-in.
3. During recording, the light of the [SONG/REC] button stays lit all the time, and the LCD will display “ING xxx”; the “xxx” means measure number.
4. Press the [START/STOP] button again to stop recording, and the light of the [SONG/REC] button will be off.
5. After recording, the recorded song will be automatically selected. Press the [START/STOP] button to start the playback.

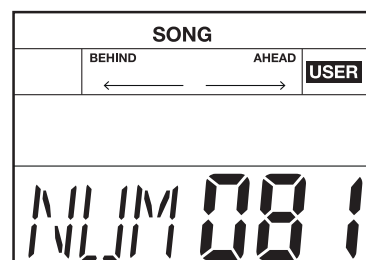
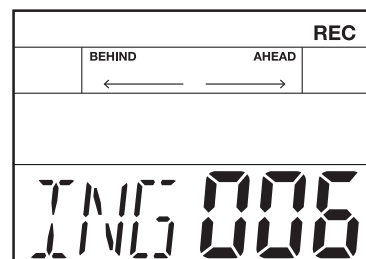
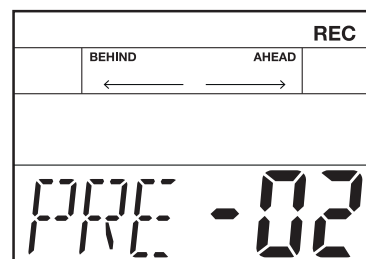

Notes:

1. When the storage is used up, the LCD will temporarily display “REC FUL”. Recording will stop and be saved automatically.
2. When you use a user kit for recording, if you change the user kit setting, this recording may not play back correctly.

Coach Mode

Coach is a practice mode which is specially designed for beginners to help improve their playing accuracy, speed and stamina, as well as other skills on the whole. It consists of three modes: Quiet Count, Beat Check and Change up. Each of them provides unique practices. Score function is available in Beat Check and Change Up. Try getting a perfect score of 100!

Coach Mode Control

1. Press the [COACH] button to enter coach mode. Then repeatedly press the [PAGE] button to select a coach type.

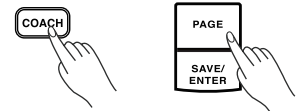

Coach Type	Display	Description
Quiet Count	QUT CNT	This helps to develop a good sense of time/tempo. There are 3 types of quiet mode and 5 selectable rhythm types.
Change Up	CHG UP	It provides 3 types of rhythm pattern to train your beat accuracy. The rhythm type will change every two measures.
Beat Check	BEA CHE	It is click accuracy practice. There are 13 selectable rhythm types.
Measure Accent	MEA	Turn on/off the accent sound.

2. Press the [SAVE/ ENTER] button to enter the selected coach type.
3. Use the [PAGE] button to select relevant parameters.
4. Press the [TEMPO] button to adjust practice speed at any time.
5. Pay attention to the LCD indicators to check the hitting accuracy when you are practicing.

Notes:

1. If you turn on score function, during the practice, it will play the click without sound.
2. If you turn off score function, during the practice, it will play the click normally.

6. Press the [COACH] button to exit the Coach Mode.

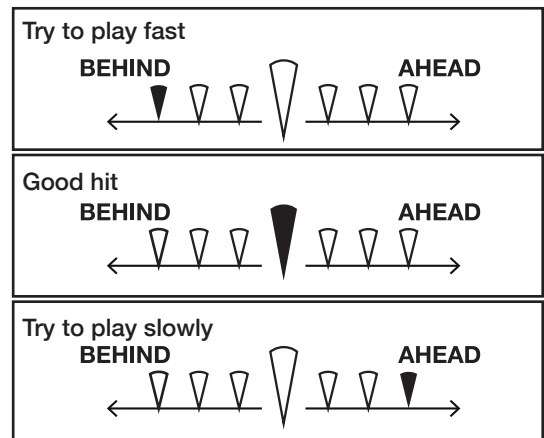

Quiet Count

In quiet count, the click will turn on/off every several measures to help you practice at steady timing and tempo.

1. Repeatedly press the [PAGE] button to select quiet count mode.
2. Press the [SAVE/ ENTER] button to enter quiet count mode.
3. Use the [PAGE] button switch between QUT and CNT parameters. Press the [←]/[→] button or turn the [DIAL] to adjust the parameter.

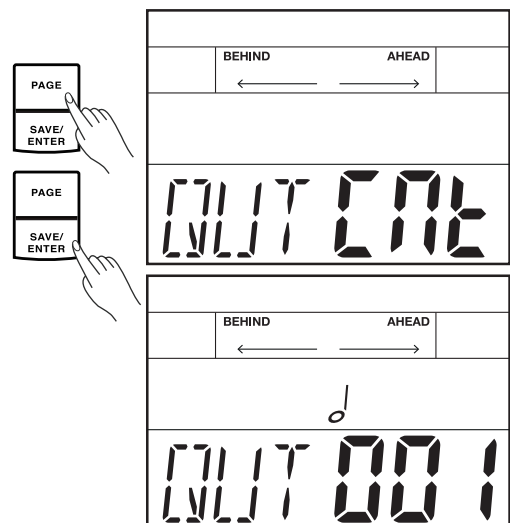

Parameters	Range	Display	Description
QUT	1~5	QUT XXX	
CNT	1-1/2-2/1-3	CNT XXX	1-1: 1 measure counts, 1 measure quiets. 2-2: 2 measure counts, 2 measure quiets. 1-3: 1 measure counts, 3 measure quiets.

4. Press the [START/ STOP] button to start practicing.
There is a count-in about 1 measure length before starting. The click will turn automatically on/ off, you have to catch up with every beat you ought to play, come on!

5. If you want to change the QUT/CNT parameter or to stop practice, press the [START/ STOP] button again.



Change Up

In change up, the rhythm type will change every two measures. The practice process starts from half note, then the note value will gradually get shorter, and then gradually get longer until it returns to half note, then this process repeats. The beat indicator will flash several times on LCD just before the rhythm type changes.

1. Repeatedly press the [PAGE] button to select change up mode.
2. Press the [SAVE/ ENTER] button to enter change up mode.
3. Use the [</>] button or turn the [DIAL] to select a suitable rhythm pattern.
4. Use the [PAGE] button to switch to score editing, then press the [</>] button or turn the [DIAL] to turn score function on/ off. The default score setting is "OFF".

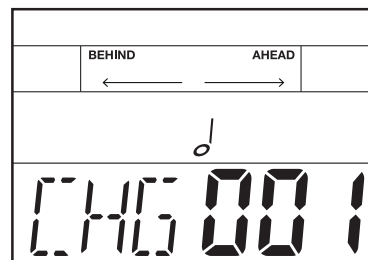
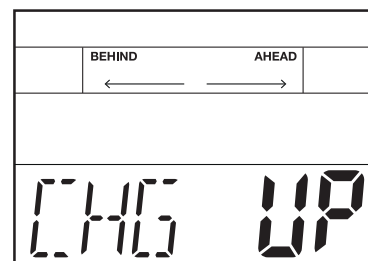

Chang Up	Range	Display	Description
CHG	1~3	CHG XXX	
SCO	ON/ OFF	SCO XXX	ON: The score setting is on. OFF: The score setting is off.

5. Press the [START/ STOP] button to start practicing.
It will play one measure of count-in before starting.
6. When score function is turned on, the practice will automatically stop after repeating several times, and display your score. Or you can press the [START/STOP] button to stop practice without the score. When score function is turned off, you can press the [START/STOP] button to stop practice.

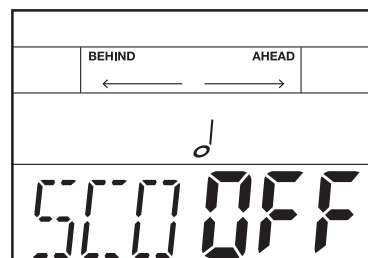

Beat Check

Beat Check provides basic beat type practices to improve your playing accuracy of each beat.

1. Repeatedly press the [PAGE] button to select beat check mode.
2. Press the [SAVE/ ENTER] button to enter beat check mode.
3. Use the [<]/[>] button or turn the [DIAL] to select a beat type to practice.
4. Use the [PAGE] button to switch to score editing, then press the [<]/[>] button or turn the [DIAL] to turn score function on/ off. The default score setting is "OFF".

Beat check	Range	Display	Description
BEA	1-13	BEA XXX	
SCO	ON, OFF	SCOXXX	ON: The score setting is on. OFF: The score setting is off.

5. Press the [START/ STOP] button to start practicing. It will play one measure of count-in before starting.
6. When score function is turned on, the practice will automatically stop after repeating several times, and display your score. Or you can press the [START/STOP] button stop practice without the score. When score function is turned off, you can press the [START/STOP] button stop practice.

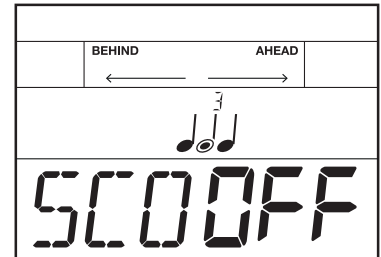
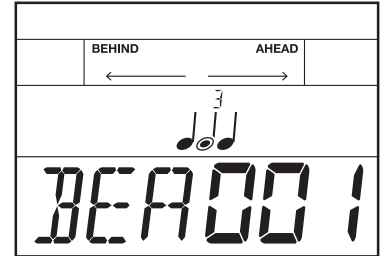
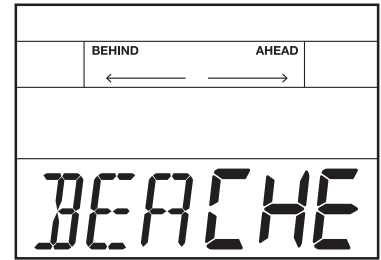

DBT (Double Bass Trigger)

Normally, it is very difficult, almost impossible, for beginners to play double bass. With DBT function, double bass pedal techniques become easy to achieve. It will generate two or three continuous kick sounds when you step on the bass drum only once.

1. Press the [DBT] button to turn DBT function on. The [DBT] button lights up.
The screen will display "DBT 1-x".
2. Use [<] / [>] or the [DIAL] to adjust the second trigger time. This setting will be remembered even after power off.

Parameter	Range	Display	Description
BEA	1-1/1-2/ 1-3/1-4	DBT XXX	1=original beat, trigger once. 2=original beat/ 2, trigger once. 3=original beat/ 3, trigger twice. 4=original beat/ 4, trigger three times.

3. As you play the bass drum, it will produce double bass sound.
4. Press the [DBT] button again to turn DBT function off.

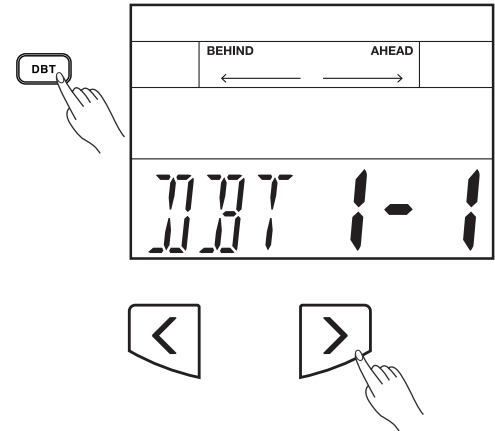

Tempo

Press the [TEMPO] button to adjust the tempo of click and song playback.

1. Press the [TEMPO] button.
2. Use the [<] / [>] button or the [DIAL] to adjust tempo value.
3. If there is no operation within 3 seconds, it will go back to previous menu automatically.

Parameter	Value	LCD Display	Description
Tempo	30-280	TMP xxx	The click and song playback will use this tempo value.

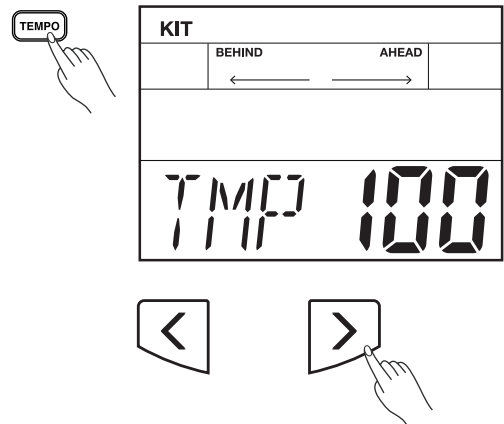

Utility Settings

This mode contains two parts: the drum pad trigger settings and drum module settings.

The Drum Pad Trigger Settings

As a professional drummer, you may want to set your drum triggers carefully to fit your playing habits and feelings, making your performance more interesting and professional.

1. Press the [UTILITY] button, the LCD will display the UTILITY menu.
2. Repeatedly press the [PAGE] button to select a trigger parameter.

Trigger parameters and their value ranges:

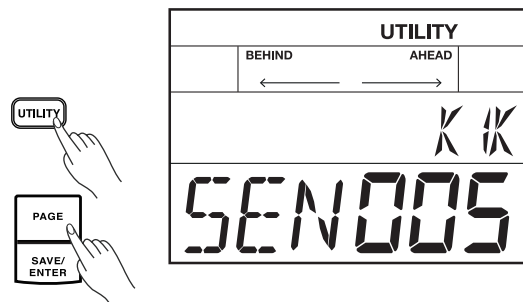

Parameter	Value	LCD Display	Description
SENSITIVITY	1~16	SEN XXX	You can adjust the sensitivity of the pads to accommodate your personal playing habit. Higher sensitivity allows the pad to produce a loud volume even when played softly. Lower sensitivity will keep the pad to producing a low volume even when played forcefully.
XTALK	1~8	XTK XXX	This setting avoids “crosstalk”, which means that when you play one pad you can hear a sound coming from another pad. This can happen when two pads are installed on the same stand. In some cases you can prevent crosstalk by increasing the distance between the two mounted pads. For example: If you hit the snare pad and the tom 1 also sounds. While striking the snare pad, gradually increase the “XTALK” value for the tom 1 pad until the tom 1 pad no longer sounds when you hit the snare pad. If you raise the “XTALK” higher, the tom 1 pad will be less prone to receive crosstalk from other pads. Note: If the value is set too high, and two pads are played simultaneously, the one that is struck less forcefully may not sound. Be careful and set this parameter to the minimum value required to prevent crosstalk.
CURVE	1~6	CUR XXX	This setting allows you to control the relation between playing velocity (striking force) and changes in volume. Adjust this curve until the response feels as natural as possible. Refer to the CURVE description.
RETRIG CANCEL	1~16	RTG XXX	This setting avoids “re-triggering”, which means that when you strike a pad once, maybe you can hear two hits coming from one strike. This can happen as the pad oscillate. While repeatedly striking the pad, raise the “Retrig Cancel” value until re-triggering no longer occurs. Although setting this to a high value prevents re-triggering, it then becomes easy for sounds to be omitted when the drums played fast (roll etc.). Set this to the lowest value possible while still ensuring that there is no re-triggering.
MIDI NOTE	0~127	MID XXX	MIDI output key mapping

3. Strike the pad to select it for editing.
4. Use the [<]/[>] button or the [DIAL] to adjust the parameter value.



Note:

The Curve descriptions are shown below:

Curve 1: The standard setting. This produces the most natural correspondence between playing dynamics and volume change.

Curve 2, 3: Compared to Curve 1, strong dynamics produce a greater change.

Curve 4, 5: Compared to Curve 1, a soft playing produces a greater change.

Curve 6: Very little dynamic response, making it easy to maintain strong volume levels. If you are using a drum trigger as an external pad, these settings will produce reliable triggering.

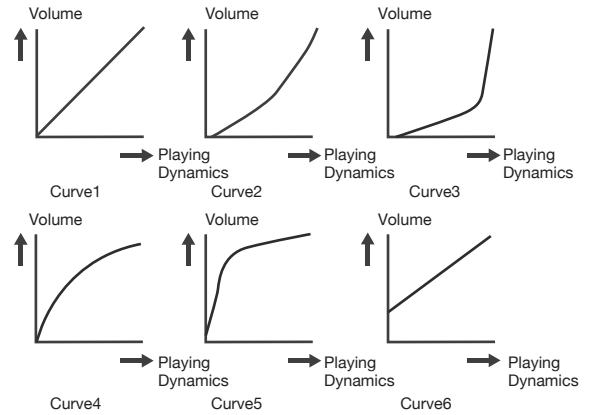

Default Midi Note:

Trigger	MIDI	Trigger	MIDI
Kick	36	Ride Bow	51
Snare Head	38	Ride Edge	59
Snare Rim	40	Crash1 Bow	49
Tom1 Head	48	Crash2 Bow	57
Tom1 Rim	50	Open Hihat	46
Tom2 Head	45	Close Hihat	42
Tom2 Rim	47	Pedal	44
Tom3 Head	43	Hihat Splash	21
Tom3 Rim	58		
Tom4 Head	41		
Tom4 Rim	39		

The Drum Module Settings

You can set the drum module function.

1. Press the [UTILITY] button, the LCD will display the UTILITY menu.
2. You can repeatedly press the [PAGE] button to select a parameter and then use the [<]/[>] button or the [DIAL] to adjust the parameter value.

Module settings and their value ranges:

Parameter	Range	LCD Display	Description
GM MODE	ON/OFF	GM XXX	ON: The channel 10 will respond GM drum kit. OFF: The channel 10 will respond local drum kit.
AUTO POWER	30, 60 ,OFF	POW XXX	Factory settings, approximately 30 minutes. 30: Automatically turns the power off if no buttons or functions are operated for approximately 30 minutes. 60: Automatically turns the power off if no buttons or functions are operated for approximately 60 minutes. OFF: The power will not power off automatically.

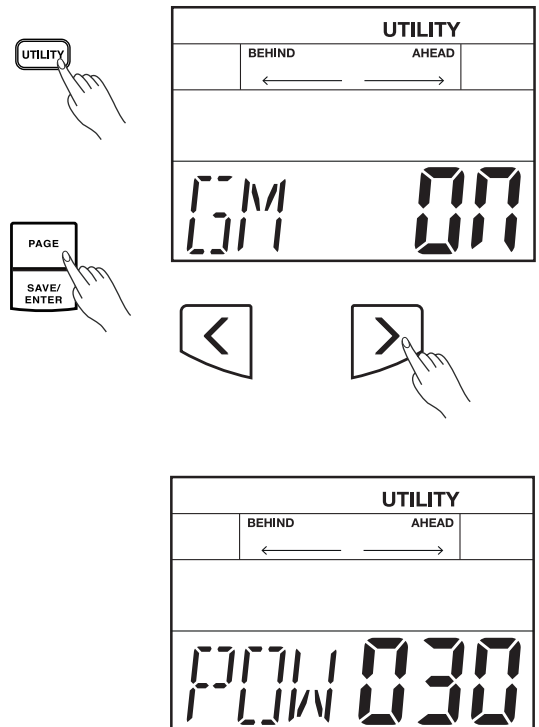

Troubleshooting

Problem	Possible Cause and Solution
No sound	Rotate the [VOLUME] knob to set an appropriate volume level.
No sound from Pads	<ol style="list-style-type: none">1. Make sure the pads are connected correctly.2. Make sure the pad volume is not set to "0".
No click sound	<ol style="list-style-type: none">1. Make sure the click is turned on.2. Make sure the click volume is not set to "0".
The Pad volume doesn't match the Song playback volume.	Adjust the song playback volume to match the pad volume.
Cannot connect to the computer	<ol style="list-style-type: none">1. Make sure the USB has correctly connected.2. Do the connect operation again (Keep the computer on, and then turn the module on, connect the USB cable).

Prompt Messages

Message	Meaning
REC FUL	The record data memory is full.
FAC SET	The factory reset of module is completed.
EMP	The user song is empty.
OK	The drum kit and utility settings are saved.
WAT	The data is loading from flash ROM now, please wait.

Specifications

Maximum Polyphony

64

Drum kits

Kit: 40 (30 Presets + 10 Users)

GM Drum Kit: 9 GM Drum Kits

Instruments

Instrument: 408 + 11 Hi-hat Combination

Sequencer

Preset Pattern: 80

User Song: 5

Tick: 192 ticks per beat

Record: Real-time Record

Data Capacity: About 2500 notes

Tempo

30~280

Display

Backlit LCD

Connectors

TRIGGER INPUT Connector(DB25), PHONES, OUTPUT (R, L/MONO), TOM4, CRASH2, MIDI OUT, AUX IN, USB-MIDI

Control Buttons

Power on/off, Master Volume, Click, Kit/ Voice, Save/ Enter, Drum Off, DBT, Coach, Song/ Rec, Start/Stop, Utility, Tempo, </>, Page, Dial.

Power Supply

DC 9V, 500mA

Dimensions

125(W) X 220 (L) X 55 (H) mm

Module Weight

0.5 kg

* All specifications and appearances are subject to change without notice.

Drum Kit List

No.	PRESET KIT
1	Acoustic
2	Funk
3	Standard
4	Jazz Brush
5	Dance
6	Rock
7	Jazz
8	808
9	909
10	Funk Band
11	FX Mix
12	Power
13	Latin
14	Room
15	Marimba

No.	PRESET KIT
16	Percussion
17	90's Power
18	Indian
19	African
20	Electronic
21	Reggae
22	Fusion
23	Brush
24	Orchestra
25	HipHop
26	Live
27	House
28	Vintage
29	Chinese 1
30	Chinese 2

Drum Voice List

No.	NAME
KICK	
1	22" Acoustic Kick 1
2	22" Acoustic Kick 2
3	24" Standard Kick
4	Brush Kick 1
5	Brush Kick 2
6	Jazz Kick
7	22" Rock Kick
8	Room Kick
9	Fusion Kick
10	1970's Kick
11	Vintage Kick
12	HipHop Kick
13	Reggae Kick
14	808 Kick
15	909 Kick
16	Electronic Kick
17	Power Kick
18	Dance Kick
19	FX Mix Kick
20	Techno Kick
SNARE	
21	14" Acoustic Snare
22	14" Acoustic Snare Rim
23	14" Standard Snare
24	14" Standard Snare Rim
25	14" Funk Snare 1
26	14" Funk Snare Rim 1
27	14" Funk Snare 2
28	14" Funk Snare Rim 2
29	Brush Snare 1
30	Brush Snare Rim 1
31	Brush Snare 2
32	Brush Snare Rim 2
33	14" Jazz Snare
34	14" Jazz Snare Rim
35	14" Rock Snare
36	14" Rock Snare Rim
37	13" Damped Snare 1
38	13" Damped Snare 2
39	13" Damped Snare 3
40	Orchestra Snare
41	Orchestra Snare Rim
42	Room Snare
43	Room Snare Rim
44	Fusion Snare
45	Fusion Snare Rim
46	Big Band Snare
47	Big Band Snare Rim
48	Vintage Snare
49	Vintage Snare Rim
50	Live Snare
51	Live Snare Rim
52	Reggae Snare
53	Reggae Snare Rim

54	R&B Snare
55	R&B Snare Rim
56	808 Snare
57	808 Snare Rim
58	909 Snare
59	909 Snare Rim
60	Electronic Snare
61	Power Snare
62	Dance Snare
63	Dance Snare Rim
64	House Snare
65	House Snare Rim
66	Lo-Fi Snare
67	Lo-Fi Snare Rim
68	Techno Snare
69	Techno Snare Rim
70	Acoustic Snare Stick
71	Standard Snare Stick 1
72	Brush Snare Stick
73	Standard Snare Stick 2
74	Rock Snare Stick 1
75	Rock Snare Stick 2
76	Live Snare Stick
77	Room Snare Stick
78	Fusion Snare Stick
79	808 Snare Stick
80	909 Snare Stick
81	Electronic Snare Stick
82	House Snare Stick
83	Lo-Fi Snare Stick
84	Techno Snare Stick
85	Brush Swirl
TOM	
86	Acoustic Tom 1
87	Acoustic Tom 1 Rim
88	Acoustic Tom 2
89	Acoustic Tom 2 Rim
90	Acoustic Tom 3
91	Acoustic Tom 3 Rim
92	Acoustic Tom 4
93	Acoustic Tom 4 Rim
94	Acoustic Tom 5
95	Acoustic Tom 5 Rim
96	Acoustic Tom 6
97	Acoustic Tom 6 Rim
98	Brush Tom 1
99	Brush Tom 1 Rim
100	Brush Tom 2
101	Brush Tom 2 Rim
102	Brush Tom 3
103	Brush Tom 3 Rim
104	Brush Tom 4
105	Brush Tom 4 Rim
106	Brush Tom 5
107	Brush Tom 5 Rim

108	Brush Tom 6
109	Brush Tom 6 Rim
110	Funk Tom 1
111	Funk Tom 1 Rim
112	Funk Tom 2
113	Funk Tom 2 Rim
114	Funk Tom 3
115	Funk Tom 3 Rim
116	Funk Tom 4
117	Funk Tom 4 Rim
118	Funk Tom 5
119	Funk Tom 5 Rim
120	Funk Tom 6
121	Funk Tom 6 Rim
122	Jazz Tom 1
123	Jazz Tom 1 Rim
124	Jazz Tom 2
125	Jazz Tom 2 Rim
126	Jazz Tom 3
127	Jazz Tom 3 Rim
128	Jazz Tom 4
129	Jazz Tom 4 Rim
130	Jazz Tom 5
131	Jazz Tom 5 Rim
132	Jazz Tom 6
133	Jazz Tom 6 Rim
134	Fusion Tom 1
135	Fusion Tom 2
136	Fusion Tom 3
137	Fusion Tom 4
138	808 Tom 1
139	808 Tom 2
140	808 Tom 3
141	808 Tom 4
142	808 Tom 5
143	808 Tom 6
144	808 Tom Fx 1
145	808 Tom Fx 2
146	909 Tom 1
147	909 Tom 2
148	909 Tom 3
149	909 Tom 4
150	909 Tom 5
151	909 Tom 6
152	909 Tom 7
153	909 Tom 8
154	Electronic Tom 1
155	Electronic Tom 2
156	Electronic Tom 3
157	Electronic Tom 4
158	Electronic Tom 5
159	Electronic Tom 6
160	Electronic Tom 7
161	Electronic Tom 8
162	Power Tom 1

163	Power Tom 2
164	Power Tom 3
165	Power Tom 4
166	Power Tom 5
167	Power Tom 6
168	90's Power Tom 1
169	90's Power Tom 2
170	90's Power Tom 3
171	90's Power Tom 4
172	90's Power Tom 5
173	90's Power Tom 6
RIDE	
174	21" Acoustic Ride
175	21" Acoustic Ride Edge
176	21" Acoustic Ride Bell
177	Brush Ride 1
178	Brush Ride 2
179	20" Funk Ride
180	20" Funk Ride Edge
181	20" Funk Ride Bell
182	20" Rock Ride
183	20" Rock Ride Edge
184	20" Rock Ride Bell
185	808 Ride
186	20" Room Ride
187	20" Room Ride Edge
188	20" Room Ride Bell
189	House Ride
190	House Ride Edge
191	House Ride Bell
192	Lo-Fi Ride
193	Lo-Fi Ride Edge
194	Lo-Fi Ride Bell
195	Junkyard Ride
196	Junkyard Ride Edge
197	Junkyard Ride Bell
CRASH	
198	16" Acoustic Crash 1
199	16" Acoustic Crash 1 Edge
200	16" Acoustic Crash 2
201	16" Acoustic Crash 2 Edge
202	16" Standard Crash 1
203	16" Standard Crash 1 Edge
204	16" Standard Crash 2
205	16" Standard Crash 2 Edge
206	Brush Crash 1
207	Brush Crash 2
208	Brush Crash 3
209	Funk Crash 1
210	Funk Crash 1 Edge
211	Funk Crash 2
212	Funk Crash 2 Edge
213	19" Jazz Crash 1
214	19" Jazz Crash 1 Edge

215	19" Jazz Crash 2
216	19" Jazz Crash 2 Edge
217	Rock Crash 1
218	Rock Crash 1 Edge
219	Rock Crash 2
220	Rock Crash 2 Edge
221	808Crash
222	909Crash 1
223	909Crash 2
224	Electronic Crash 1
225	Electronic Crash 2
226	Orchestra Crash 1
227	Orchestra Crash 2
228	Orchestra Crash 3
229	Room Crash
230	Room Crash Edge
231	Vintage Crash 1
232	Vintage Crash 1 Edge
233	Vintage Crash 2
234	Vintage Crash 2 Edge
235	Big Band Crash 1
236	Big Band Crash 1 Edge
237	Big Band Crash 2
238	Big Band Crash 2 Edge
239	Latin Crash 1
240	Latin Crash 1 Edge
241	Latin Crash 2
242	Latin Crash 2 Edge
243	China 1
244	China 1 Edge
HIHAT	
245	14" Acoustic Hi-hat
246	14" Acoustic Hi-hat Edge
247	14" Acoustic Hi-hat Pedal
248	14" Acoustic Hi-hat Splash
249	14" Standard Hi-hat
250	14" Standard Hi-hat Edge
251	14" Standard Hi-hat Pedal
252	14" Standard Hi-hat Splash
253	Brush Hi-hat
254	Brush Hi-hat Pedal
255	Brush Hi-hat Splash
256	14" Rock Hi-hat
257	14" Rock Hi-hat Edge
258	14" Rock Hi-hat Pedal
259	14" Rock Hi-hat Splash
260	808 Hi-hat
261	808 Hi-hat Pedal
262	808 Hi-hat Splash
263	909 Hi-hat
264	909 Hi-hat Pedal
265	909 Hi-hat Splash
266	Dance Hi-hat
267	Dance Hi-hat Pedal

268	Dance Hi-hat Splash
PERCUSSION	
269	Maracas
270	Metronome Bell
271	Vibra-slap 1
272	Vibra-slap 2
273	Vibra-slap 3
274	Synthesis Percussion 1
275	Synthesis Percussion 2
276	High Q 1
277	High Q 2
278	Low Q 1
279	Low Q 2
280	Mute Hi Conga 1
281	Mute Hi Conga 2
282	Open Hi Conga 1
283	Open Hi Conga 2
284	Low Conga
285	High Bongo
286	Low Bongo
287	High Timbale 1
288	High Timbale 1 Rim
289	High Timbale 2
290	High Timbale 2 Rim
291	Low Timbale 1
292	Low Timbale 2
293	Low Timbale 2 Rim
294	Low Timbale 3
295	Low Timbale 4
296	High Agogo
297	Low Agogo
298	Claves
299	Jingle Bell
300	Cowbell
301	Bell Tree 1
302	Bell Tree 2
303	Tambourine
304	Cabasa
305	Long Guiro
306	Short Guiro
307	Indian 1
308	Indian 2
309	Indian 3
310	Indian 4
311	Indian 5
312	Indian 6
313	Indian 7
314	Indian 8
315	Indian 9
316	Indian 10
317	Indian 11
318	Indian 12
319	Indian 13
320	Indian 14

Drum Voice List

321	Indian 15
322	Indian 16
323	Indian 17
324	African 1
325	African 2
326	African 3
327	African 4
328	African 5
329	African 6
330	African 7
331	African 8
332	African 9
333	African 10
334	African 11
335	African 12
336	African 13
337	African 14
338	African 15
339	African 16
340	African 17
341	Marimba C3
342	Marimba C4
343	Marimba D4
344	Marimba E4
345	Marimba F4
346	Marimba G4
347	Marimba A4
348	Marimba B4
349	Marimba C5
350	Marimba D5
351	Marimba E5
352	Marimba F5
353	Marimba G5
354	Marimba A5
355	Marimba B5
356	Marimba C6
357	Orchestra Timp E2
358	Orchestra Timp F2
359	Orchestra Timp Gb2
360	Orchestra Timp G2
361	Orchestra Timp Ab2
362	Orchestra Timp A2
363	Orchestra Timp Bb2
364	Orchestra Timp B2
365	Orchestra Timp C3
FX	
366	FX 1
367	FX 2
368	FX 3
369	FX 4
370	FX 5
371	FX 6
372	FX 7
373	FX 8

374	FX 9
375	FX 10
376	FX 11
377	FX 12
378	FX 13
379	FX 14
380	FX 15
381	FX 16
382	FX 17
383	FX 18
CHINESE	
384	DaGu 1
385	DaGu 2
386	ZhuBan
387	NanBang
388	DaMuYu
389	SMuYu-1
390	SMuYu-2
391	SMuYu-3
392	SMuYu-4
393	PaiGu 1
394	PaiGu 2
395	PaiGu 3
396	MangLuo 1
397	MangLuo 2
398	MangLuo 3
399	DaLuo 1
400	DaLuo 2
401	DaPo 1
402	DaPo 2
403	XiaoPo
404	XiaoLuo
405	TenLuo
406	PengLing
407	DogLuo
408	Mute

Song List

No.	Name
1	Funk1
2	Rock N'Roll1
3	Dance1
4	Pop1
5	Fusion1
6	R&B1
7	BritPop
8	R&B2
9	GtrBossa
10	Rock Ballad
11	Folk
12	Funk Shuffle
13	Ele Pop1
14	Pop2
15	Bossa Nova1
16	Samba1
17	Fusion2
18	Ele Pop2
19	Pop Shuffle
20	Rock1
21	Latin1
22	Latin2
23	Salsa1
24	Smooove
25	Steve Vai Funk
26	70's Funk
27	Jazz1
28	6/8Soul1
29	Fusion2
30	Dance funk
31	Dance2
32	DJ.House
33	Ele Pop3
34	Hip Hop
35	Pop3
36	Pop4
37	R&B3
38	Reggae1
39	Rock2
40	Rock3
41	Blues Funk
42	Fusion3
43	Cool Jazz
44	Ballad
45	Samba2
46	Vintage Hip-Hop
47	Nu Jazz Funk
48	Soul
49	R&B4
50	Big Band 1

51	Ska
52	Classic Rock
53	Hardcore Hip-Hop
54	Vintage Dance Pop
55	Nu-Metal
56	Salsa2
57	Eu Hip-Hop
58	Bossa Nova2
59	Fusion 4
60	8Beat Pop
61	Jazzy Funk
62	Swing Big Band
63	Raggae 1
64	60's Pop
65	Vintage Funk
66	Trance
67	Heavy Rock
68	Swing
69	Punk
70	8Beat
71	Disco House
72	3/4 Folk
73	Samba3
74	Latin Rock
75	Reggae 2
76	Dance3
77	Country Pop
78	Country
79	PopRock
80	DancePop

GM Drum Kit List

Note No.	Standard (bank 00)	Funk (bank 08)	Rock (bank 16)	Electric (bank 24)	Analog (bank 25)
Eb1[27]	High Q				
E 1[28]	Slap				
F 1[29]	Scratch Push				
F#1[30]	Scratch Pull				
G 1[31]	Sticks				
G#1[32]	Square Click				
A 1[33]	Metronome Click				
Bb1[34]	Metronome Bell				
B 1[35]	Acoustic Bass Drum				
C 2[36]	Bass Drum 1	Funk Kick	Rock Kick Drum	Electric Bass Drum	Analog Bass Drum
C#2[37]	Side Stick				Analog Rim Shot
D 2[38]	Acoustic Snare	Funk Snare 1	Rock Snare Drum1	Electric Snare 1	Analog Snare 1
Eb2[39]	Hand Clap				Analog Clap
E 2[40]	Electric Snare	Funk Snare 2	Rock Snare Drum2	Electric Snare 2	Analog Snare 2
F 2[41]	Low Floor Tom	Funk LowTom2	Rock LowTom2	Electric Low Tom 2	Analog Low Tom2
F#2[42]	Closed Hi-hat				Analog Closed Hi-hat
G 2[43]	High Floor Tom	Funk LowTom1	Rock LowTom1	Electric Low Tom 1	Analog Low Tom1
G#2[44]	Pedal Hi-hat				Analog Pedal Hi-hat
A 2[45]	Low Tom	Funk MidTom2	Rock MidTom2	Electric Mid Tom 2	Analog Mid Tom2
Bb2[46]	Open Hi-hat				Analog Open Hi-hat
B 2[47]	Low-Mid Tom	Funk MidTom1	Rock MidTom1	Electric Mid Tom 1	Analog Mid Tom1
C 3[48]	High Mid Tom	Funk Hi Tom2	Rock HiTom2	Electric Hi Tom 2	Analog Hi Tom2
C#3[49]	Crash Cymbal 1				Analog Cymbal
D 3[50]	High Tom 1	Funk Hi Tom1	Rock HiTom1		Analog Hi Tom1
Eb3[51]	Ride Cymbal 1				
E 3[52]	China Cymbal				
F 3[53]	Ride Bell				
F#3[54]	Tambourine				
G 3[55]	Splash Cymbal				
G#3[56]	Cowbell				
A 3[57]	Crash Cymbal 2				
Bb3[58]	Vibra-slap				
B 3[59]	Ride Cymbal 2				
C 4[60]	High Bongo				
C#4[61]	Low Bongo				
D 4[62]	Mute Hi Conga				
Eb4[63]	Open Hi Conga				
E 4[64]	Low Conga				
F 4[65]	High Timbale				
F#4[66]	Low Timbale				
G 4[67]	High Agogo				
G#4[68]	Low Agogo				
A 4[69]	Cabasa				
Bb4[70]	Maracas				
B 4[71]	Short Whistle				
C 5[72]	Long Whistle				
C#5[73]	Short Guiro				
D 5[74]	Long Guiro				
Eb5[75]	Claves				
E 5[76]	Hi Wood Block				
F 5[77]	LowWood Block				
F#5[78]	Mute Cuica				
G 5[79]	Open Cuica				
G#5[80]	Mute Triangle				
A 5[81]	Open Triangle				
Bb5[82]	Shaker				
B 5[83]	Jingle Bell				
C 6[84]	Bell Tree				
C#6[85]	Castanets				
D 6[86]	Mute Surdo				
Eb6[87]	Open Surdo				

GM Drum Kit List

Note No.	Jazz (bank 32)	Brush (bank 40)	Orchestra (bank 48)	Dance (bank 56)
Eb1[27]			Closed Hi-hat 2	
E 1[28]			Pedal Hi-hat	
F 1[29]			Open Hi-hat 2	
F#1[30]			Ride Cymbal 1	
G 1[31]				
G#1[32]				
A 1[33]				
Bb1[34]				
B 1[35]			Concert BD 2	
C 2[36]	Jazz Kick 1	Brush Kick 1	Concert BD 1	Dance Bass Drum
C#2[37]				
D 2[38]	Jazz Snare 1	Brush Tap	Concert SD	Dance Snare 1
Eb2[39]			Castanets	
E 2[40]	Jazz Snare 2	Brush Slap	Concert SD	Dance Snare 2
F 2[41]		Brush Low Tom2	Timpani F	Dance Low Tom2
F#2[42]			Timpani F#	Dance Closed
G 2[43]		Brush Low Tom1	Timpani G	Hi-hat
G#2[44]			Timpani G#	Dance Low Tom1
A 2[45]		Brush Mid Tom2	Timpani A	Dance Pedal Hi-hat
Bb2[46]			Timpani A#	Dance Mid Tom2
B 2[47]		Brush Mid Tom1	Timpani B	Dance Open Hi-hat
C 3[48]		Brush Hi Tom2	Timpani c	Dance Mid Tom1
C#3[49]			Timpani c#	Dance Hi Tom2
D 3[50]		Brush Hi Tom1	Timpani d	Dance Cymbal
Eb3[51]			Timpani d#	Dance Hi Tom1
E 3[52]			Timpani e	
F 3[53]			Timpani f	
F#3[54]				
G 3[55]				
G#3[56]				
A 3[57]				
Bb3[58]				
B 3[59]				
C 4[60]				
C#4[61]				
D 4[62]				
Eb4[63]				
E 4[64]				
F 4[65]				
F#4[66]				
G 4[67]				
G#4[68]				
A 4[69]				
Bb4[70]				
B 4[71]				
C 5[72]				
C#5[73]				
D 5[74]				
Eb5[75]				
E 5[76]				
F 5[77]				
F#5[78]				
G 5[79]				
G#5[80]				
A 5[81]				
Bb5[82]				
B 5[83]				
C 6[84]				
C#6[85]				
D 6[86]				
Eb6[87]				

GM Backing Instrument List

PIANO	
1	Acoustic Grand Piano
2	Bright Acoustic Piano
3	Electric Grand Piano
4	Honky-Tonk Piano
5	E.Piano 1
6	E.Piano 2
7	Harpsichord
8	Clavi
MALLET	
9	Celesta
10	Glockenspiel
11	Music Box
12	Vibraphone
13	Marimba
14	Xylophone
15	Tubular Bells
16	Dulcimer
ORGAN	
17	Drawbar Organ
18	Percussive Organ
19	Rock Organ
20	Church Organ
21	Reed Organ
22	Accordion
23	Harmonica
24	Tango Accordion
GUITAR	
25	Nylon Guitar
26	Steel Guitar
27	Jazz Guitar
28	Clean Guitar
29	Muted Guitar
30	Overdriven Guitar
31	Distortion Guitar
32	Guitar Harmonics
BASS	
33	Acoustic Bass
34	Finger Bass
35	Pick Bass
36	Fretless Bass
37	Slap Bass 1
38	Slap Bass 2
39	Synth Bass 1
40	Synth Bass 2
STRINGS	
41	Violin
42	Viola
43	Cello
44	Contrabass
45	Tremolo Strings
46	Pizzicato Strings
47	Orchestral Harp
48	Timpani

STRINGS ENSEMBLE	
49	Strings Ensemble 1
50	Strings Ensemble 2
51	Synth Strings 1
52	Synth Strings 2
53	Choir Aahs
54	Voice Oohs
55	Synth Voice
56	Orchestra Hit
BRASS	
57	Trumpet
58	Trombone
59	Tuba
60	Muted Trumpet
61	French Horn
62	Brass Section
63	Synth Brass 1
64	Synth Brass 2
REED	
65	Soprano Sax
66	Alto Sax
67	Tenor Sax
68	Baritone Sax
69	Oboe
70	English Horn
71	Bassoon
72	Clarinet
PIPE	
73	Piccolo
74	Flute
75	Recorder
76	Pan Flute
77	Blown Bottle
78	Shakuhachi
79	Whistle
80	Ocarina
LEAD	
81	Lead1 (Square)
82	Lead2 (Sawtooth)
83	Lead3 (Calliope)
84	Lead4 (Chiff)
85	Lead5 (Charang)
86	Lead6 (Voice)
87	Lead7 (Fifths)
88	Lead8 (Bass & Lead)
PAD	
89	Pad1 (Newage)
90	Pad2 (Warm)
91	Pad3 (Polysynth)
92	Pad4 (Choir)
93	Pad5 (Bowed)
94	Pad6 (Metallic)
95	Pad7 (Halo)
96	Pad8 (Sweep)

EFFECTS	
97	FX1 (Rain)
98	FX2 (Soundtrack)
99	FX3 (Crystal)
100	FX4 (Atmosphere)
101	FX5 (Brightness)
102	FX6 (Goblins)
103	FX7 (Echoes)
104	FX8 (Sci-fi)
ETHNIC	
105	Sitar
106	Banjo
107	Shamisen
108	Koto
109	Kalimba
110	Bagpipe
111	Fiddle
112	Shanai
PERCUSSIVE	
113	Tinkle Bell
114	Agogo
115	Steel Drums
116	Wood Block
117	Taiko Drum
118	Melodic Tom
119	Synth Drum
120	Reverse Cymbal
SOUND EFFECTS	
121	Guitar Fret Noise
122	Breath Noise
123	Seashore
124	Bird Tweet
125	Telephone Ring
126	Helicopter
127	Applause
128	Gunshot

