

# DIGITAL PIANO

---

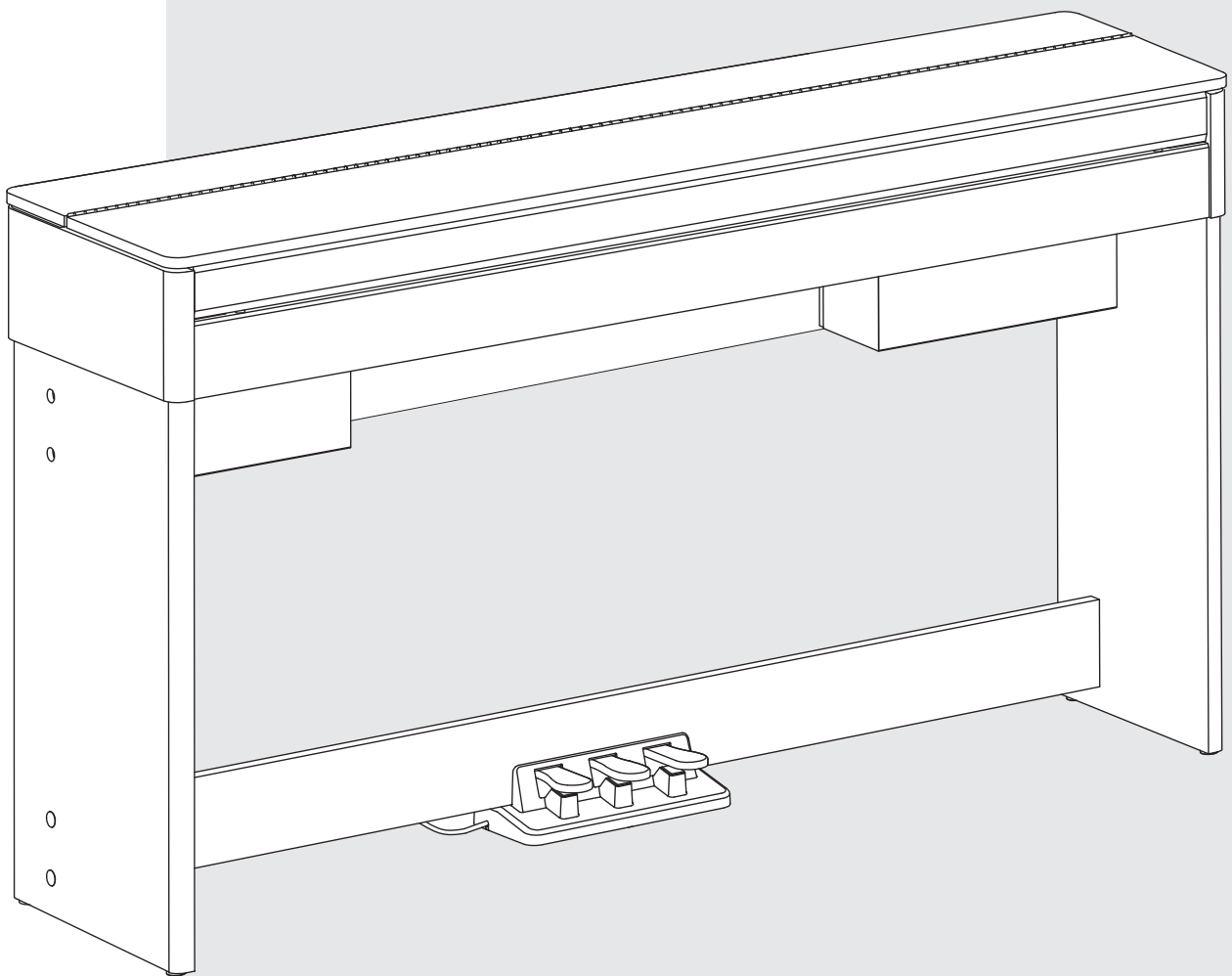

**Owner's Manual**

# INFORMATION FOR YOUR SAFETY!

## THE FCC REGULATION WARNING (for USA)

This equipment has been tested and found to comply with the limits for a Class B digital device, pursuant to Part 15 of the FCC Rules.

These limits are designed to provide reasonable protection against harmful interference in a residential installation. This equipment generates, uses, and can radiate radio frequency energy and, if not installed and used in accordance with the instructions, may cause harmful interference to radio communications. However, there is no guarantee that interference will not occur in a particular installation. If this equipment does cause harmful interference to radio or television reception, which can be determined by turning the equipment off and on, the user is encouraged to try to correct the interference by one or more of the following measures:

- Reorient or relocate the receiving antenna.
- Increase the separation between the equipment and receiver.
- Connect the equipment into an outlet on a circuit different from that to which the receiver is connected.
- Consult the dealer or an experienced radio/TV technician for help.

Unauthorized changes or modification to this system can void the user's authority to operate this equipment.

### CAUTION

The normal function of the product may be disturbed by Strong Electro Magnetic Interference. If so, simply reset the product to resume normal operation by following the owner's manual. In case the function could not resume, please use the product in other location.

## PRECAUTIONS

### PLEASE READ CAREFULLY BEFORE PROCEEDING

Please keep this manual in a safe place for future reference.

#### Power Supply

When removing the electric plug from an outlet, always hold the plug itself and not the cord.

Do not connect the instrument to an electrical outlet using a multiple-connector or an AC outlet of voltage other than that for which your instrument is intended.

Remove the electric plug from the outlet when the instrument is not to be used for extended periods of time, or during electrical storms.

#### Connections

Before connecting the instrument to other devices, turn off the power to all units. This will help prevent malfunction and / or damage to other devices.

#### Location

Do not expose the instrument to the following conditions to avoid deformation, discoloration, or more serious damage:

- Direct sunlight
- Extreme temperature or humidity
- Excessive dusty or dirty location
- Strong vibrations or shocks
- Close to magnetic fields

#### Interference with other electrical devices

Radios and televisions placed nearby may experience reception interference. Operate this unit at a suitable distance from radios and televisions.

#### Cleaning

Clean only with a soft, dry cloth.

Do not use paint thinners, solvents, cleaning fluids, or chemical-impregnated wiping cloths.

#### Handling

Do not apply excessive force to the switches or controls.

Do not let paper, metallic, or other objects into the instrument. If this happens, remove the electric plug from the outlet. Then have the instrument inspected by qualified service personnel.

Disconnect all cables before moving the instrument.

# Contents

<b>Panel &amp; Display Description</b>	
Front Panel.....	4
LCD.....	4
Rear Panel.....	5
Pedal.....	5
<b>Setup</b>	
Setup Guide.....	6
Power Supply.....	9
<b>Connections</b>	
Connecting a pair of Headphones.....	10
Connecting an Audio Equipment.....	10
Connecting an MP3/CD Player.....	10
Connecting a Computer.....	10
<b>Adjusting the Master Volume</b> .....	11
<b>Adjusting the Voice Brilliance</b> .....	11
<b>Playing the Demo Song</b> .....	11
<b>Playing Voices</b>	
Playing Voices.....	12
Playing two voices simultaneously-DUAL.....	12
Playing Different Voices with Both hands-LOWER... ..	12
Touch.....	13
Transpose.....	13
Piano mode.....	14
Metronome.....	14
Twinova.....	14
Scale.....	15
<b>Auto Accompaniment</b>	
Play Auto Accompaniment (rhythm track only).....	16
Play Auto Accompaniment (all tracks).....	16
Accompaniment Sections.....	16
Playing Different Accompaniment Sections.....	17
Accompaniment Volume.....	18
Chord Fingering.....	18
Tempo.....	19
One Touch Setting.....	19
<b>Harmony</b>	
Harmony Switch.....	20
Play with harmony effect.....	20
<b>Performance Assistant</b>	
What's the performance assistant?.....	21
Enter the Performance Assistant.....	21
Guitar Mode.....	21
Playing in Guitar Mode.....	22
Piano Mode.....	22
Playing in Piano Mode.....	22
Exit the Performance Assistant.....	22
<b>DSP Effect</b> .....	23
<b>Mixer</b> .....	23
<b>Pedal Function</b> .....	24
<b>Function Menu</b>	
Tune.....	25
KeySplit.....	25
Beat Type.....	26
Metro Volume.....	26
Pedal Type.....	26
Reverb Volume.....	26
Chorus Volume.....	27
Harmony Type.....	27
Harmony Speed.....	27
MIDI In.....	28
MIDI OUT.....	28
PowerOff.....	28
Performance Beat Type.....	28
<b>Restore Factory Setting</b> .....	29
<b>Register Memory</b>	
Registering the Panel Setting.....	29
Recalling the Registered Panel Settings.....	29
Selecting a Registration Bank.....	29
Accompaniment Freeze.....	30
<b>Song Album</b> .....	30
<b>Song Recording</b>	
Start Recording.....	31
Stop Recording.....	32
Playback Recording.....	32
Delete User Song.....	32
<b>Song</b>	
Listen to the songs.....	33
Song Control.....	33
Practice Song.....	33
<b>MIDI</b>	
What's MIDI?.....	34
Upload/Download Data from the Computer.....	34
<b>Troubleshooting</b> .....	35
<b>Specifications</b> .....	35
<b>Appendices</b>	
Voice List.....	36
Style List.....	41
Song List.....	43
Album List.....	43
Chord List.....	45
MIDI Implementation Chart.....	46
Scale Tuning System.....	47

# Panel & Display Description

## Front Panel

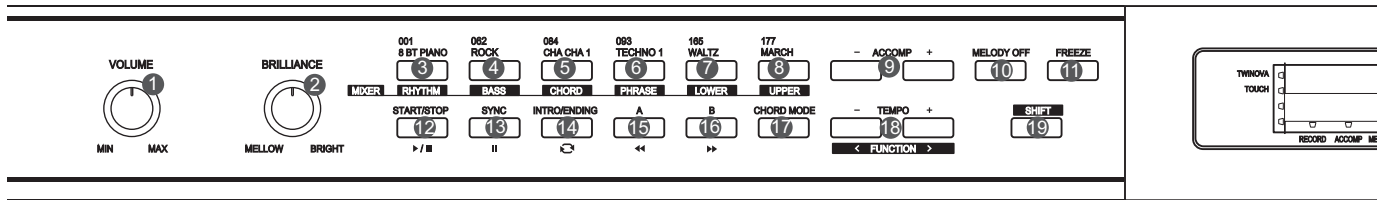

1. **[VOLUME] knob**  
Adjust master volume
2. **[BRILLIANCE] knob**  
Adjust voice brilliance
9. **[ACCOMP] button**  
Adjust the ACCOMP volume
10. **[MELODY OFF] button**  
Enter MELODY OFF state
11. **[FREEZE] button**  
Freeze the style parameter.
17. **[CHORD MODE] button**  
Choose chord mode
19. **[SHIFT] button**  
Select the second function of some buttons

- When **[SHIFT]** button pressed
3. **[RHYTHM] button**  
Adjust the RHYTHM volume
  4. **[BASS] button**  
Adjust BASS volume
  5. **[CHORD] button**  
Adjust CHORD volume
  6. **[PHRASE] button**  
Adjust the PHRASE volume
  7. **[LOWER] button**  
Adjust LOWER volume
  8. **[UPPER] button**  
Adjust UPPER volume
  18. **[FUNCTION+/-] button**  
Choose the function menu

- When **[SHIFT]** button released
- 3~8. **Style direct button**  
Shortcut to select a style
  18. **[TEMPO+/-] button**  
Adjust the tempo

- SONG MODE:**
12. **[START/STOP] button**  
Start or stop playing the song
  13. **[PAUSE] button**  
Pause or continue playing the song
  14. **[REPEAT A/B] button**  
Set the beginning and ending location of loop to the current song
  15. **[REW] button**  
Rewind the song
  16. **[FF] button**  
Fast forward the song
- STYLE MODE :**
12. **[START/STOP] button**  
Start or stop playing the style
  13. **[SYNC START] button**  
Turn the Sync Start on or off
  14. **[INTRO/ENDING] button**  
Play the Intro or Ending
  15. **[FILL A] button**  
A Fill-in A plays
  16. **[FILL B] button**  
A Fill-in B plays

## LCD

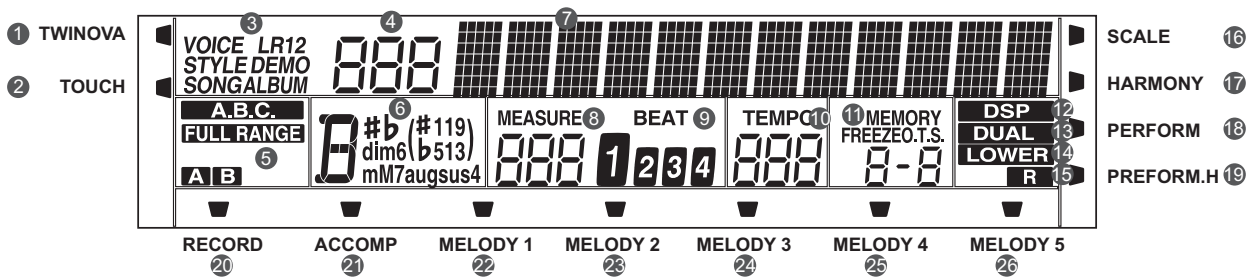

1. Twinova
2. Touch
3. Voice/Style/Demo/Song/Album
4. Number
5. A.B.C./Full range/Accompaniment section
6. Chord
7. Character
8. Measure
9. Beat
10. Tempo
11. Memory/Freeze/O.T.S./Bank
12. DSP effect
13. Dual voice
14. Lower voice
15. Right hand
16. Scale
17. Harmony
18. Performance assistant
19. Performance assistant high
20. Record
21. ACCOMP track
22. MELODY 1 track
23. MELODY 2 track
24. MELODY 3 track
25. MELODY 4 track
26. MELODY 5 track

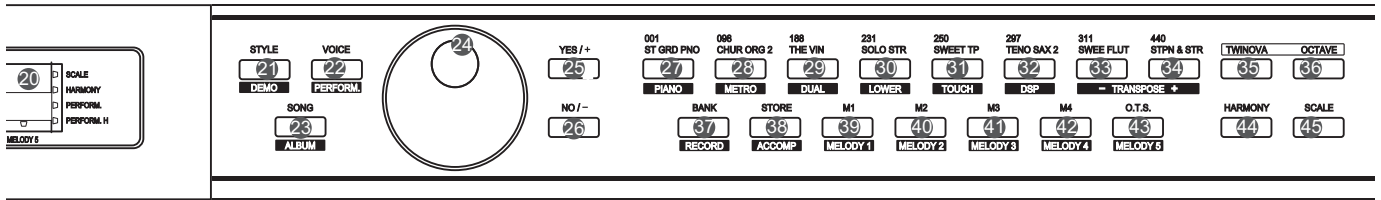

### When [SHIFT] button released

- 21. **[STYLE] button**  
Enter style mode
- 22. **[VOICE] button**  
Enter voice mode
- 23. **[SONG] button**  
Enter song mode and play songs
- 27~34. **Voice direct button**  
Shortcut to select a voice
- 37. **[BANK] button**  
Adjust the memory bank
- 38. **[STORE] button**  
Register the current panel settings
- 39~42. **M1~M4 button**  
Recall the registered panel settings
- 43. **[O.T.S] button**  
Turn one touch setting on or off

### When [SHIFT] button pressed

- 38. **[ACCOMP] button**  
Select the accomp track to record
- 39~43. **MELODY 1-5 button**  
Select the melody1-5 track to record

### When [SHIFT] button pressed

- 21. **[DEMO] button**  
Enter demo mode
- 22. **[PERFORM] button**  
Enter the Performance Assistant mode
- 23. **[ALBUM] button**  
Enter album mode
- 27. **[PIANO] button**  
Select the piano mode
- 28. **[METRONOME] button**  
Turn the metronome on or off
- 29. **[DUAL] button**  
Turn the Voice R2 on or off
- 30. **[LOWER] button**  
Turn the Voice L on or off
- 31. **[TOUCH] button**  
Choose a keyboard touch setting
- 32. **[DSP] button**  
Turn the DSP effect on or off
- 33~34. **[TRANSPOSE+/-] button**  
Adjust the transpose
- 37. **[RECORD] button**  
Enter record mode

### 20. LCD

Display the information of the piano

### 24. Data dial

Adjust the value

### 25~26. [YES/+]/[NO/-] button

Adjust the value

### 35. [TWINOVA] button

Turn the TWINOVA on or off

### 36. [OCTAVE] button

Set octave in TWINOVA mode

### 44. [HARMONY] button

Turn harmony effect on or off

### 45. [SCALE] button

Turn the scale effect on or off

## Rear Panel

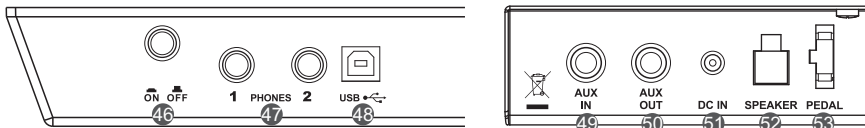

### 46. POWER ON / OFF

Turn the power on or off

### 47. PHONES 1 AND 2

Connect the headphone

### 48. USB Jack

Connect to a computer.

### 49. AUX. IN Jack

Connect an external sound source, Such as an Mp3 or CD player.

### 50. AUX. OUT Jack

Connect the audio equipment.

### 51. DC IN Jack

Connect the DC 15V power adaptor.

### 52. SPEAKER Jack

Connect the speaker.

### 53. PEDAL Jack

Connect to the pedals.

## Pedal

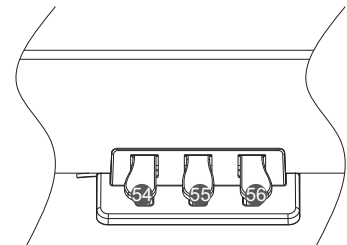

### 54. Soft Pedal

When you step on the soft pedal, all notes played on the keyboard will have a softer effect.

### 55. Sostenuto Pedal

When you step on the sostenuto pedal, the notes played before you step on the pedal would have a sustain effect.

### 56. Sustain Pedal(multi function pedal)

When you step on the sustain pedal, all notes played on the keyboard will have a longer sustain

# Setup

This section contains information about setting up your instrument and preparing to play. Carefully read this section before turning the power on.

## Setup Guide

Before you begin assembling the instrument, check that all the parts below were supplied.

You also need to have a Phillips screwdriver.

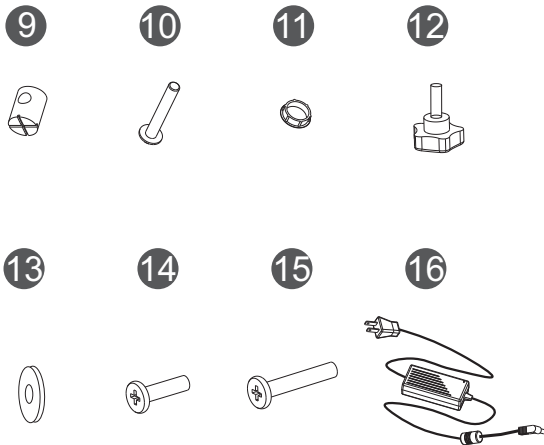
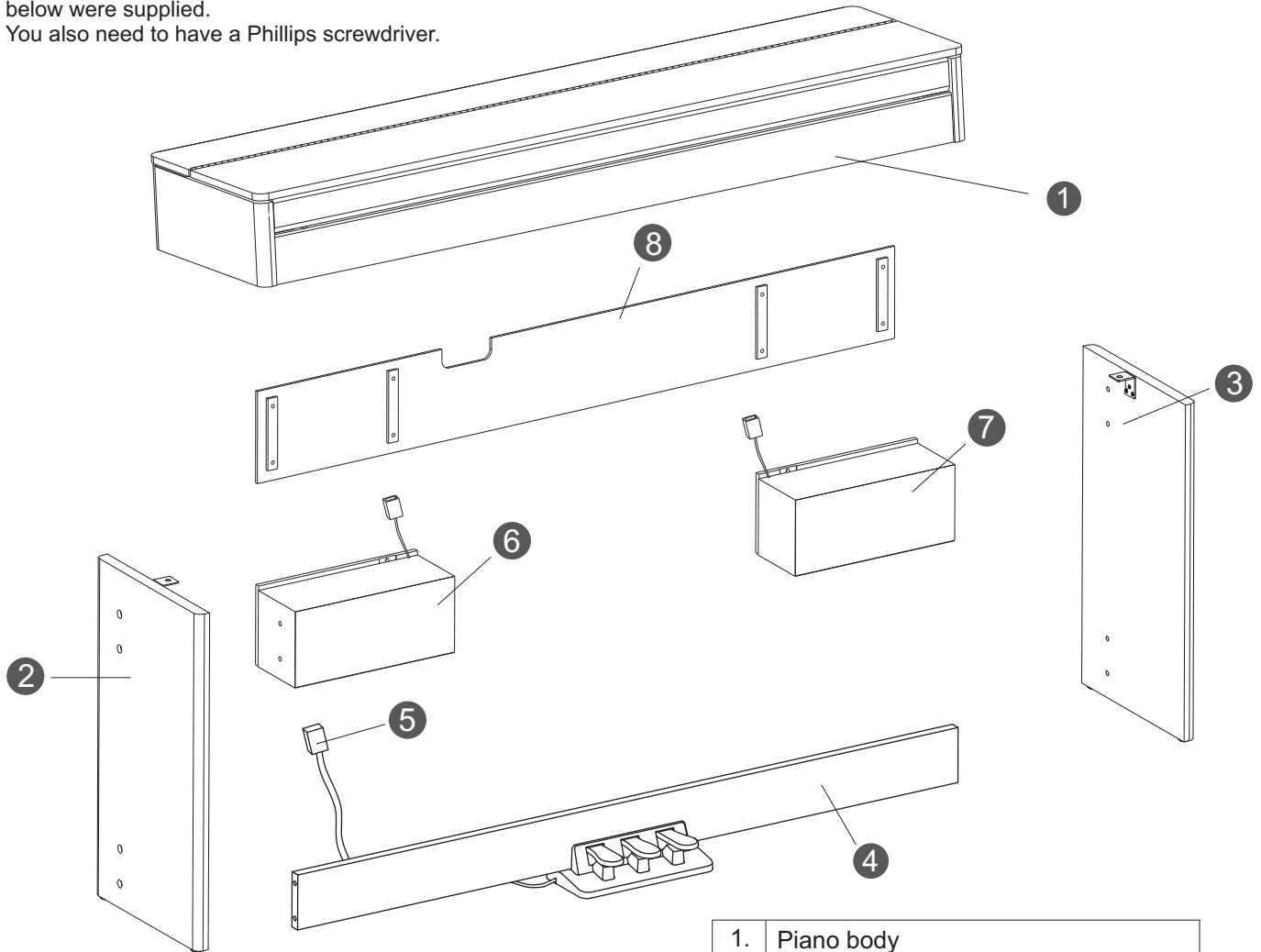

1.	Piano body
2.	Left leg component
3.	Right leg component
4.	Foot pedal assembly
5.	Foot pedal cable
6.	Left sound box
7.	Right sound box
8.	Back board
9.	Turned nut (4PCS)
10.	Screws M6x50 (8PCS)
11.	Plastic screw cap (8PCS)
12.	Hand screws (2PCS)
13.	Gasket (2PCS)
14.	Screws M4x15 (2PCS)
15.	Screws M6x24 (8PCS)
16.	AC power adaptor

**A. Install the piano legs as shown below.**

First, insert the four Turned Nuts into the holes at the back of the Pedal Panel.

Second, align both the left and the right legs to each side of the Pedal Panel.

Third, insert the a screws M6x50 through the screw holes and fit them into the Turned Nuts.

Finally, tighten with a screwdriver and place the plastic caps on top. (Check the components in the right direction before installing.)

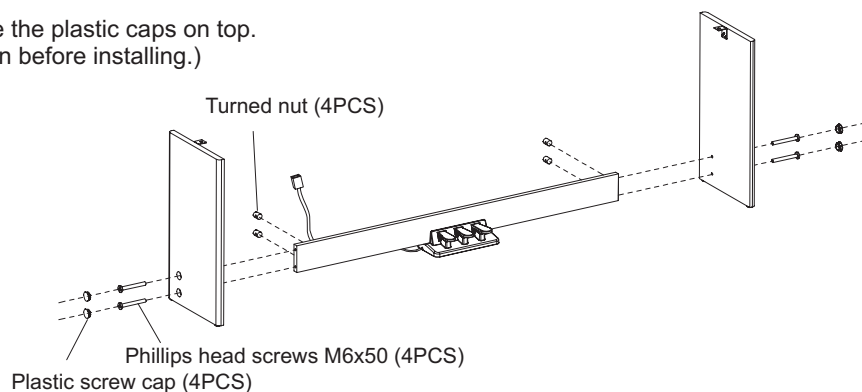

**B. As shown below, Place the piano body on the stand, fix it with two hand screws.**

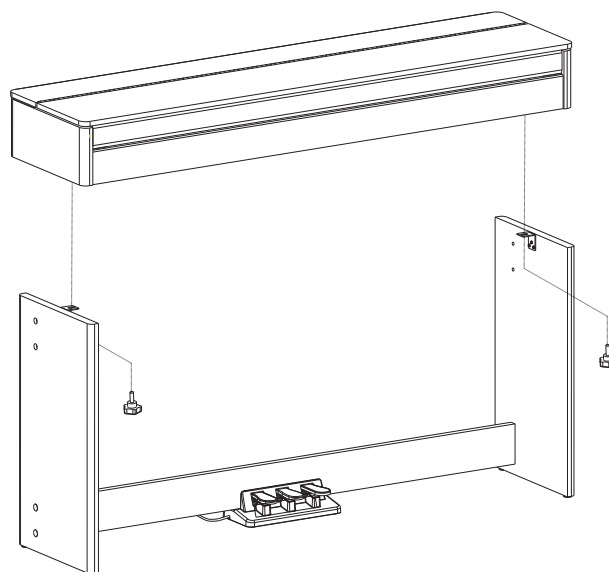

**C. Install the Sound Boxes as shown below.**

First, place the sound boxes as shown.

Second, insert the screws M6x50 through holes on the legs and fit them into the sound box. Tighten with a screwdriver and place the plastic caps on top.

Third, insert the screws M4x15 through the sound boxes and fit them into the holes at the bottom of The Piano. Tighten with a screwdriver.

Finally, insert the sound box cables into the socket at the bottom of the Piano body.

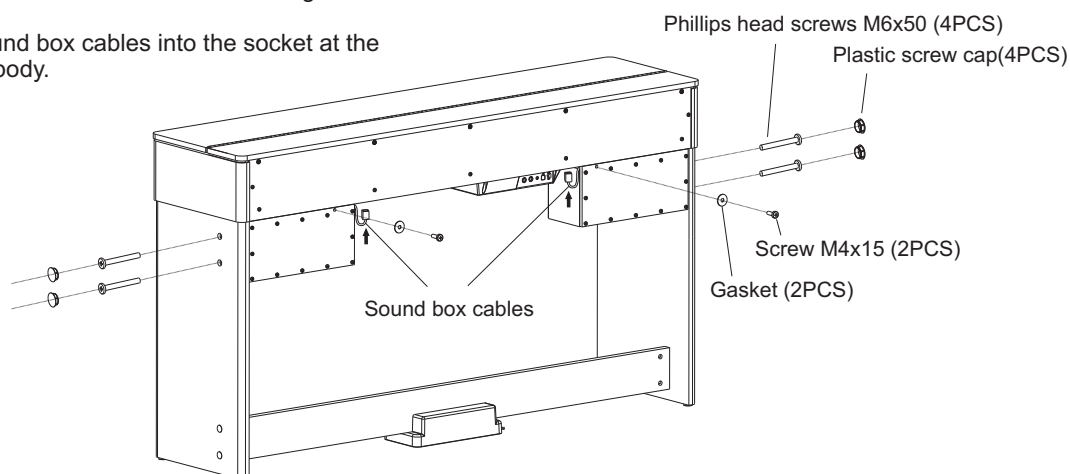

# Setup

D. Insert the pedal cord to the Pedal jack at the rear of The Piano and fix the cord to the sound boxes with a cable tie.

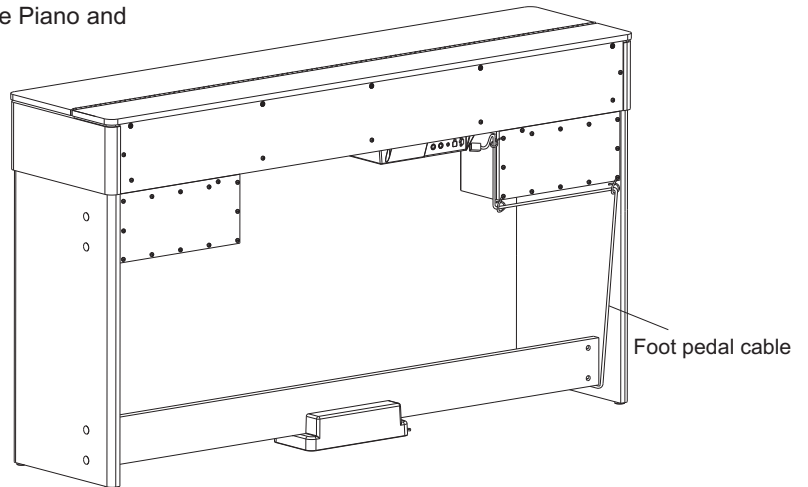

E. Fix the back board to the sound box cover (left and right) with gasket and screw M4X24.

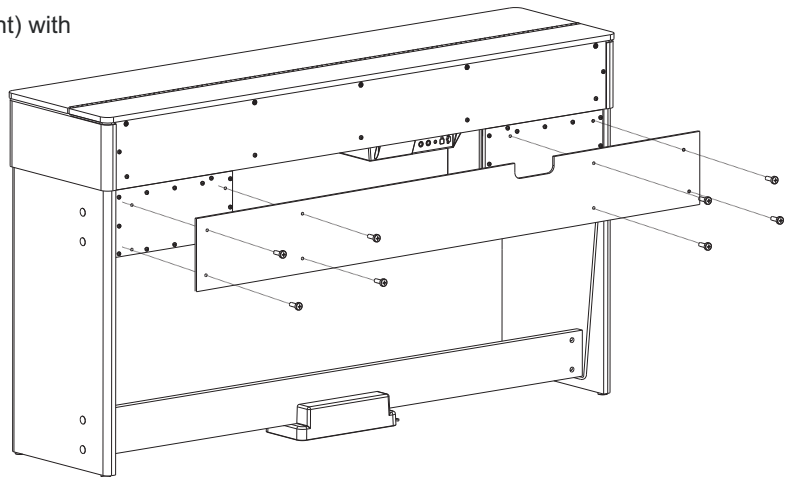

F. Connect the power cord to the DC IN jack at the rear of the piano, and then plug it to an AC outlet. The installation is completed now. Turn on the power and enjoy the perfect performance.

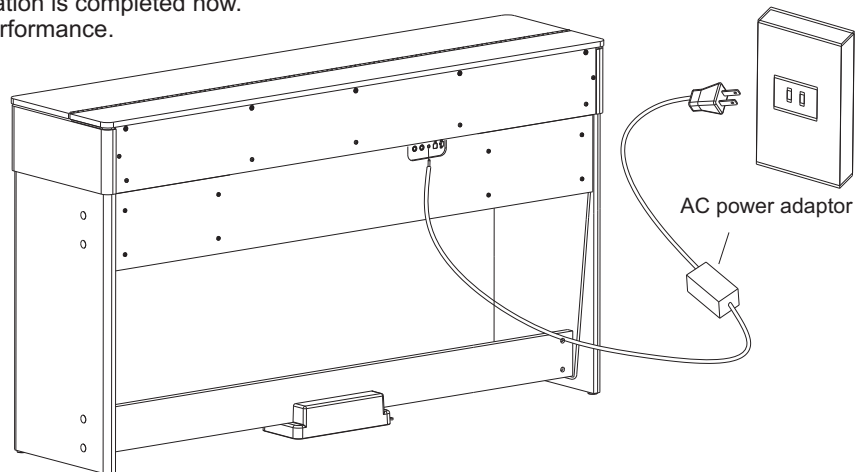



## Power Supply

1. Make sure that the piano is turned off. Before you switch your piano on or off, turn down the volume of piano and any connected audio equipments first.
2. Connect the AC adaptor to the DC power jack instrument.
3. Connect the power cable to the AC outlet.
4. Press the [POWER] switch, the LCD will display "Loading." which indicates the piano has powered on.
5. If you are ready to turn off the piano, press the [POWER] switch again.

### Note:

1. In the idle mode, the piano will automatically shutdown in 30 minutes if you do not take any action on the piano.
2. When the keyboard is not in use or during thunderstorm, please disconnect the power for safety purpose.

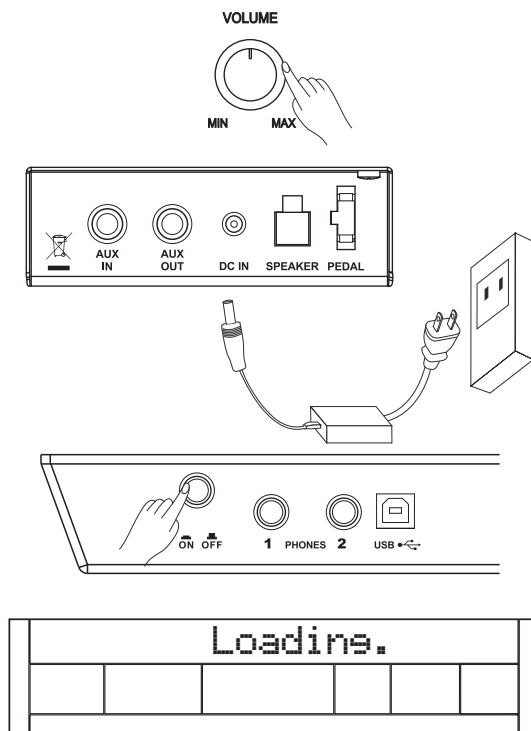

# Connections

## Connecting a pair of Headphones

A standard pair of stereo headphones can be plugged in here for private practice or late-night playing.

**Jack1:** when a pair of headphones is plugged into the jack 1, the internal stereo speaker system is automatically shut off. The sound can only be heard from headphones.

**Jack2:** when a pair of headphones is plugged into the jack 2, the sound can be heard from both headphones and speakers of the instrument.

**Note:**

To avoid the risk of hearing loss when using headphones, please do not play the piano with a high volume level for a long time.

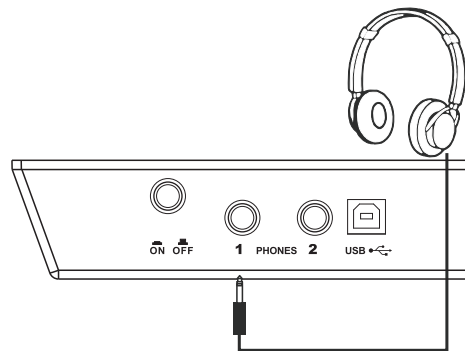

## Connecting an Audio Equipment

The rear-panel AUX.OUT jack delivers the output of the instrument for connection to a keyboard amplifier, stereo sound system, a mixing console, or tape recorder. Use an audio cord to plug into the AUX OUT jack located on the rear panel then plug the other end of the cord into AUX.IN of the amplifier.

**Note:**

To avoid damaging the speakers, please ensure that the volume has been set to the minimum level before connecting the power and other devices.

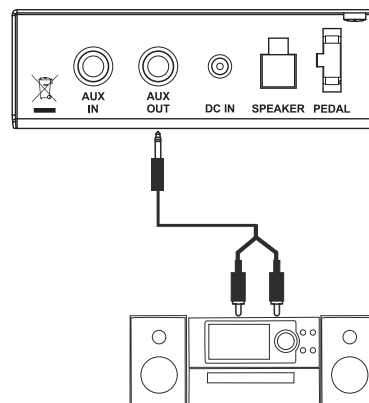

## Connecting an MP3/CD Player

Connect the audio output of an MP3/CD player or other audio source to the stereo AUX IN jack on the rear panel.

The input signal is mixed with the piano signal, allowing you to play along the music.

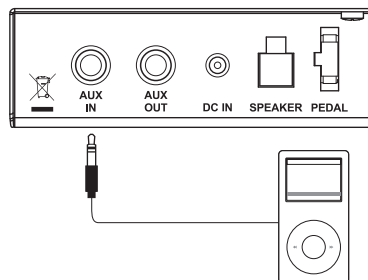

## Connecting a Computer

The instrument receives and transmits MIDI messages via the USB connector.

Connecting the MIDI IN /OUT to Computer via The MIDI/USB converter.

**Note:**

If this product does not work correctly when connected to a USB 3.0 port, you will need to connect to a USB 2.0 port.

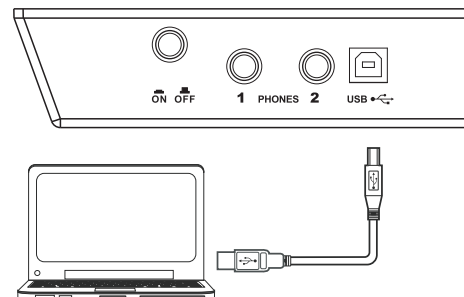

# Adjusting the Master Volume

Turn the [VOLUME] knob clockwise, the volume increases and vice versa.

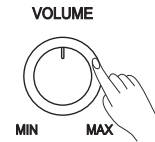

# Adjusting the Voice Brilliance

Turn the [BRILLIANCE] knob clockwise, the voice sounds brighter and vice versa. You can change the piano brilliance as you wish.



# Playing the Demo Song

The instrument features 5 wonderful demos. Please refer to Demo List.

1. Holding down [SHIFT] button, then press the [DEMO] button to start demo song playing, and the LCD will display the number and name of demo.
2. You can use the data dial, the [+ / YES] / [- / NO] button to select a demo song.
3. Press the [START/STOP] button to stop playing. Holding down [SHIFT] button, then press the [demo] button to exit demo mode.

## Note:

In the demo status, all the demo songs will loop playing. And all buttons and keys are unavailable except [DEMO], [START/STOP], [TEMPO+/-], [+ / YES], [- / NO] button, data dial, [VOLUME] knob, [BRILLIANCE] knob and POWER SWITCH.

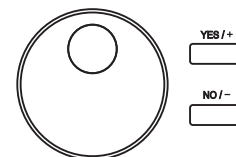

# Playing Voices

The instrument features 500 exceptionally realistic voices. Please refer to **Voices List**.

## Playing Voices

1. In idle mode, press [VOICE] button or one of the voice direct buttons to enter the voice mode. LCD will display the "VOICE R1" indicate, and display the current voice name and number.
2. Use the data dial, [+ /YES] / [- /NO] button to select a voice you want to play. You can also use the voice direct button to select one.
3. You can play the keyboard and listen to the wonderful voice.

### Note:

When the DUAL and LOWER function is on, you can press [VOICE] button repeatedly to choose the voice source. The corresponding LCD indicate will highlight between R1, R2, L.

## Playing two voices simultaneously-DUAL

The piano has a dual voice function. You can play two voices to make the sound more richly.

1. In idle mode, holding down [SHIFT] button, and then press [DUAL] button to turn dual function on. The LCD displays the current voice name and number, and the indicate "VOICE R 2" and "DUAL"
2. You can use the data dial, the [+ /YES], [- /NO] button or voice direct button to select the dual voice you want to play.
3. Play the keyboard, and then you will hear two different voices are sounded simultaneously in a layer. It seems like two different instruments playing at the same time.
4. When dual function is on, holding down [SHIFT] button, and then pressing [DUAL] button will turn dual function off.

### Note:

When the keyboard has been split, only the right hand area will respond the dual voice, the left hand will not respond to it.

## Playing Different Voices with Both hands-LOWER

The lower function splits the keyboard into two section. Each section can be set to a voice. The left section voice is lower voice.

1. In idle mode, holding down [SHIFT] button, and then press [LOWER] button to turn the lower function on. The keyboard is split into two independent sections, and each section has its voice. The LCD displays the left hand voice name and number, and the indicate "VOICE L" and "LOWER"
2. You can use the data dial, the [+ /YES], [- /NO] button or voice direct button to select the lower voice you want to play.

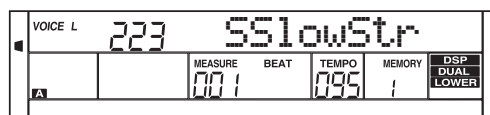
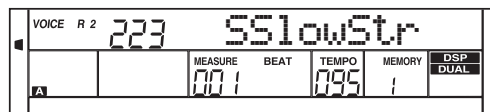

3. Play the keyboard in different sections, and you will hear two different voices.
4. When lower function is on, holding down [SHIFT] button, and then pressing [LOWER] button will turn lower function off.

**Note:**

The right hand voice does not change when you change lower voice.

### Split Point

The Point on the keyboard that separates voice L and voice R1/R2 is called the "split point". The split point is set to F#3 at the factory setting. However you can set this to any key you want. Refer to KeySplit setting for split point setting.

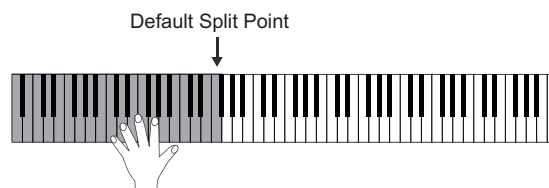

## Touch

The piano is equipped with a touch response feature that lets you dynamically and expressively controls the level of the voice with your playing strength just as on an acoustic instrument.

The piano has three touch types to choose.

1. Holding down [SHIFT] button, and then press [TOUCH] button to enter touch settings. LCD displays the touch setting number. The default number is 2.
2. Choose a touch type. When LCD displays touch setting, using [+ /YES] / [- /NO] or data dial or holding down [SHIFT] button, and then pressing [TOUCH] button can change touch type: OFF, 001(soft), 002(normal), 003(hard). Pressing [+ /YES] and [- /NO] simultaneously will set touch value to default setting: 2(normal).

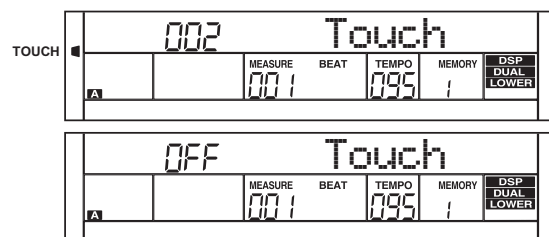

## Transpose

Transpose function allows the overall pitch of the instrument to be transposed up or down by a maximum of one octave in semitone steps.

1. Holding down [SHIFT] button, and then press [TRANSPOSE+] or [TRANSPOSE-] button to enter transpose settings. LCD displays the current transpose: xxx Transpos. The default number is 0.
2. When LCD displays the current transpose, use [+ /YES] / [- /NO] or data dial to change transpose value. The max transpose is  $\pm 12$  semitones.
3. Press [+ /YES] and [- /NO] simultaneously will set the transpose value to its default setting: 000 Transpos.



**Note:**

If you want to play song in G key, you can set the transpose to -05 or 007, then you can play the G scale using C scale keys. Transpose setting is applied to all part of the music and keyboard.

# Playing Voices

## Piano Mode

This function is to set the voice of the whole keyboard to piano instantly.

1. Holding down [SHIFT] button, and then press [PIANO] button can enter or exit piano mode.
2. In piano mode, the accompaniment control is the same to other mode.  
The accompaniment only plays the rhythm part.

### Note:

1. In piano mode, you can set the mixer function and enter function menu.
2. In piano mode, the A.B.C. is automatically turned off.

## Metronome

Using metronome helps you with beat that guides your playing by preset tempo.

1. Holding down [SHIFT] button, and then press the [METRO] button to turn the metronome on or off.
2. Metronome beat type setting  
Please refer to **Beat Type Setting**.

### Note:

1. The metronome will respond in the next beat if it is opened when the accompaniment is playing.
2. When the metronome is on, then start the accompaniment, the metronome will adjust the beat to the accompaniment.
3. When recording, metronome beats cannot be recorded.

## Twinova

The twinova mode can split the keyboard into two sections which have the same pitch and voice. It helps teaching and learning piano.

1. Press [TWINOVA] button to turn twinova function on. The LCD indicate of twinova is lighted. In twinova mode, dual voice and lower voice are unavailable. The default split point is E3 (32). When you are ready to exit, press [TWINOVA] button again.
2. In twinova mode, the default voice of right hand and left hand is the upper voice you select before entering twinova mode. Use the data dial, the [+ / YES], [- / NO] button or the voice direct button to choose voice.
3. In twinova mode, press [OCTAVE] button, LCD temporarily displays the octave value of twinova. Now you can use the data dial, the [+ / YES], [- / NO] button to set octave value of twinova. The range of octave is -1 to 1. Press [+ / YES] and [- / NO] simultaneously will set the octave value to its default setting: 000.

### Note:

1. In the Demo and song mode, the [TWINOVA] button is invalid.
2. Please refer to KeySplit setting to set the split point setting.
3. The [OCTAVE] button is invalid outside twinova mode.  
When the octave is changed, some voices may be muted in the highest or lowest range.

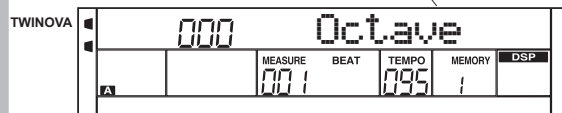
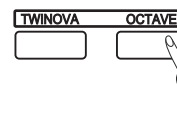
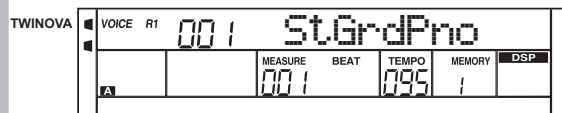
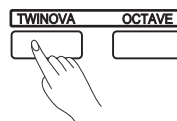
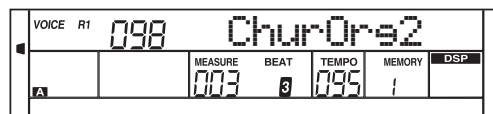

The Default Split Point is E3



## Scale

This function allows you to experience different stretched tunings when you play certain genres of music that is not composed based on twelve equal interval.

1. Press [SCALE] button can open or close scale function.  
The corresponding indicate on the LCD will light or light off.
2. Scale type and root key selection  
When the scale function is on, long press [SCALE] button to open scale setting menu. The default setting is: 001 Pytha C.  
When the scale indicate is flashing, press [+ / YES], [- / NO] button can select scale type. Use the C7-B7 key to set the root key.  
The LCD displays the scale type and root key.

The piano has six types of scale, as shown below:

Number	LCD Name
1	Pytha
2	Major
3	Minor
4	Mean Tone
5	Werck
6	Kirnberg

### Note:

1. In scale setting status, if no operation is done within 5 seconds, this status will exit automatically.
2. The scale status will exit automatically in the song mode and demo mode.

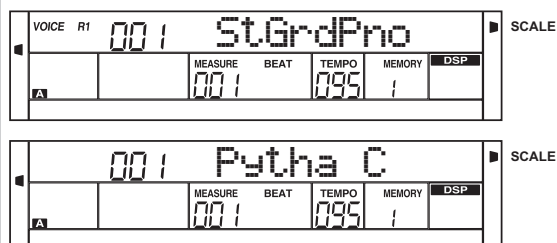
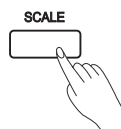

Root key selection

# Auto Accompaniment

The auto accompaniment feature puts a full backing band at your fingertips. To use it, all you have to do is to play the chords with your left hand using your selected accompaniment style, and then the accompaniment will automatically play along, instantly following the chords you play. With auto accompaniment, even a solo performer can enjoy playing with the backing of an entire band or orchestra. This keyboard features 200 styles in a variety of musical genres. Try to select some of the different styles (refer to Style List) and enjoy the auto accompaniment feature.

## Play Auto Accompaniment(rhythm track only)

1. Press any of the style direct button or [STYLE] button to enter the style mode. LCD displays the name and number of the current style.
2. Use the data dial, the [+ / YES], [- / NO] button or the style direct button to choose the style you want to play.
3. Press the [START/STOP] button to start the rhythm tracks of the auto accompaniment. Also you can press [SYNC] and then play any key to start the rhythm tracks of the auto accompaniment.

## Play Auto Accompaniment(all tracks)

1. In style mode, press [CHORD MODE] button to enter "auto bass chord" (A.B.C.) mode. The keyboard is split into two sections. Left hand section is chord detect section. The LCD will show the indicate of "A.B.C." Now pressing any key in chord detect section(Sync Start status) you will hear the fantastic accompaniment. Press [CHORD MODE] button again to enter "FULL RANGE" mode. The LCD will show the indicate of "FULL RANGE". The whole keyboard is chord detect section.
2. You can press [SYNC] button and then play a chord in chord detect section to start auto accompaniment of all tracks. When you change a chord, the accompaniment automatically changes. You can also press [START/STOP] button to start auto accompaniment of rhythm track, then play a chord in chord detect section. It will start auto accompaniment of all tracks.

### Note:

The piano can save 10 user styles. To use your styles, you should use the software of MEDELI to convert the style, then use the USB to save the styles to piano.

## Accompaniment Sections

There are various types of Auto Accompaniment sections that allow you to vary the arrangement of the accompaniment to match the song you are playing.

They are: Intro, Main (A, B), Fill (A, B), and Ending.

By switching among them during your performance you can easily produce the dynamic elements of a professional sounding arrangement in your performance.

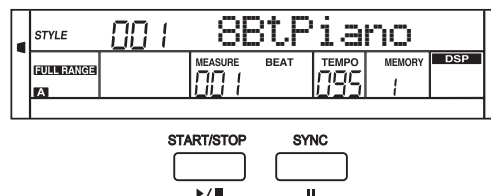
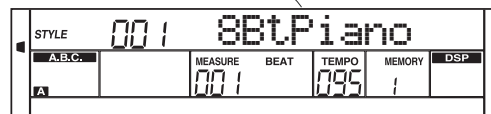
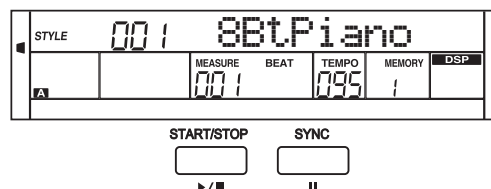
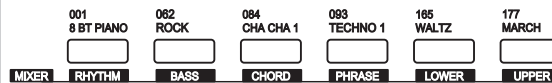

Default auto accompaniment section

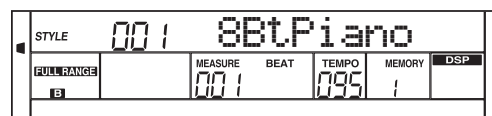
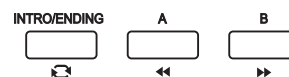
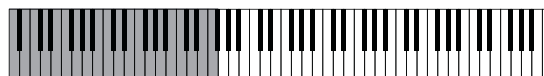



## INTRO Section

The intro is an opening section of the song. Each preset style features two different patterns. When the intro pattern finished, the system will automatically shift to the main section.

## MAIN Section

The main is an important section of the song. And it plays an accompaniment pattern and repeat infinitely until another section's button is pressed.

## FILL IN Section

Auto fill in function automatically adds a fill to your performance. When the fill-in is finished, accompaniment shifts to the Main section (A, B,).

## ENDING Section

Ending is used for the ending of the song. When the ending is finished, accompaniment automatically stops. The length of the ending differs depending on the selected style.

### Note:

Hold down the FILL A/B button when the style is playing, the selected fill-in pattern repeats continuously until button is released.

Press FILL A/B button when style stops, it will change to the normal section.

## Playing Different Accompaniment Sections

1. Press the [STYLE] button
2. Press style direct button or use the data dial, [+ / YES] / [- / NO] button to select a style.
3. Press [CHORD MODE] button to enter A.B.C. (auto bass chord) mode.
4. Press [SYNC] button.
5. Press [FILL A] button.
6. Press the [INTRO/ENDING] button. Now the "A" indicate on LCD, and the style is ready to play.
7. It will start the accompaniment as soon as you start playing in Chord section. When the playback of the intro is finished, it automatically leads into Main A section.
8. Press the [FILL B] button. A fill-in plays, automatically followed by the Main B section.
9. Press the [INTRO/ENDING] button again, and it will enter the Ending Section. When the ending is finished, the auto accompaniment automatically stops.

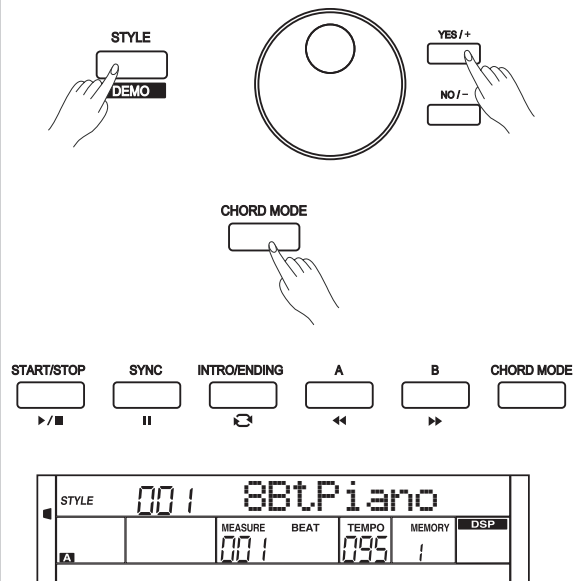

# Auto Accompaniment

## Accompaniment Volume

This function is used to change the volume of all tracks of accompaniment.

1. Press [ACCOMP] button, the LCD will display ACCOMP volume (0 to 127). At this time, you can use the data dial, or [+ / YES] / [- / NO] button to adjust ACCOMP volume.
2. When the LCD will displays ACCOMP volume, press [+ / YES] and [- / NO] button simultaneously can mute the ACCOMP volume. The LCD displays "OFF Accomp". press [+ / YES] and [- / NO] button simultaneously again can open the ACCOMP volume.

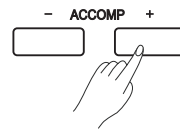

## Chord Fingering

How the chords are played or indicated with your left hand (in the auto accompaniment section of the keyboard) is referred to as "fingering". There are 2 types of fingerings as described below.

### Chord Basics

A chord, in music, is any harmonic set of three or more notes that is heard as if sounding simultaneously. The most frequently encountered chords are triads. A triad is a set of three notes that can be stacked in thirds. When stacked in thirds, the triad's members, from lowest pitched tone to highest, are called: the Root, the Third, and the Fifth.

### Triad Type

There are following basic triad types:

Major Triad	A root with a major third added above and a perfect fifth will consist as a "Major Triad".
Minor Triad	A root with a minor third added above and a perfect fifth will consist as a "Minor Triad".
Augmented Triad	A root with a major third added above and an augmented fifth will consist as an "Augmented Triad".
Diminished Triad	A root with a minor third added above and a diminished fifth will consist as a "Diminished Triad".

### Chord Inversion

We define this chord its root is not in the bass (i.e., is not the lowest note) as an inversion chord. When the root is in the bass, we call the chord: root-position chord. If we put the Third and Fifth in the root position, then it forms "Inversion", we call this chord "Inversion Chord". See the following major triad and its inverted chord.

### Chord Name

The chord name contains two parts content: Chord root and Chord type.

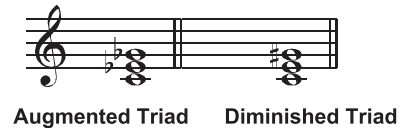
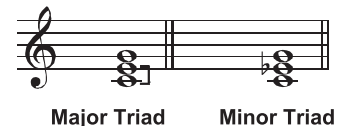
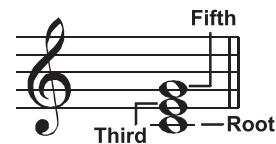

**Cm**

Chord Root    Chord Type

<b>C</b>		<b>★ Major Triad</b> Only press the root note on the keyboard.
<b>Cm</b>		<b>★ Minor Triad</b> Press the root note and the nearest left black key simultaneously.
<b>C7</b>		<b>★ Seventh chord</b> Press the root note and the nearest left white key simultaneously.
<b>Cm7</b>		<b>★ Minor seventh chord</b> Press the root note and the nearest left white and black keys simultaneously.

## SINGLE FINGER

































Single-finger makes it simple to produce major, seventh, minor and minor seventh chords by pressing a minimum number of keys on the auto accompaniment section.

## MULTI-FINGER

Multi-finger allows you to play chords in normal fingering. Try playing the 32 chord types in C scale as listed on the right.

### Note:

In full range mode, the entire keyboard will only recognize chords played in normal fingering.

0 C 	1 C <sub>6</sub> 	2 C <sub>M7</sub> 	3 C <sub>M7</sub> (#11) 	4 C <sub>M</sub> (9) 	5 C <sub>M7</sub> (9) 
6 C <sub>6</sub> (9) 	7 C <sub>aug</sub> 	8 C <sub>m</sub> 	9 C <sub>m6</sub> 	10 C <sub>m7</sub> 	11 C <sub>m7</sub> (b5) 
12 C <sub>m</sub> (9) 	13 C <sub>m7</sub> (9) 	14 C <sub>m7</sub> (11) 	15 C <sub>m</sub> M <sub>7</sub> 	16 C <sub>m</sub> M <sub>7</sub> (9) 	17 C <sub>dim</sub> 
18 C <sub>dim7</sub> 	19 C <sub>7</sub> 	20 C <sub>7sus4</sub> 	21 C <sub>7</sub> (b5) 	22 C <sub>7</sub> (9) 	23 C <sub>7</sub> (#11) 
24 C <sub>7</sub> (13) 	25 C <sub>7</sub> (b9) 	26 C <sub>7</sub> (b13) 	27 C <sub>7</sub> (#9) 	28 C <sub>M7aug</sub> 	29 C <sub>7aug</sub> 
30 C <sub>sus4</sub> 	31 C <sub>1+2+5</sub> 	Notes enclosed in parentheses are optional; the chords could be recognized without them.			

## Tempo

Each style of the instrument has been set with a default or standard tempo; however, this can be changed by using the [TEMPO+/-] buttons.

1. Use the [TEMPO+/-] button to change the tempo. While the tempo data is flashing, use the data dial can also change the tempo.

2. Press the [TEMPO+] and [TEMPO-] buttons simultaneously to restore the default tempo setting.

### Note:

The tempo will change when changing the style not playing the accompaniment. The tempo will not change when changing the style playing the accompaniment.

## One Touch Setting

When One Touch Setting is switched on, you can instantly recall all auto accompaniment related settings including voices selection and digital effects simply with a single touch of a button.

1. Press the [O.T.S.] button to turns on the One Touch Setting for current style.

2. Press one of the one touch setting buttons [M1]-[M4]. Various panel settings (such as voice, effect, etc.) that match the selected style can be instantly recalled with just a single button press.

Auto accompaniment is automatically turned on during O.T.S. mode.

One Touch Setting parameter list:

Part ON/OFF (VOICE R1, R2, L)

Voice Change (VOICE R1, R2, L)

Voice Volume (VOICE R1, R2, L)

Voice Reverb Level (VOICE R1, R2, L)

Voice Chorus Level (VOICE R1, R2, L)

### Note:

- In O.T.S. mode, the A.B.C. function would turn on automatically.
- In O.T.S. mode, the memory cannot be registered.

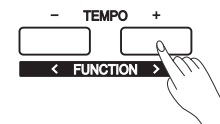

# Harmony

The harmony function can add harmony effect to the main voice.

## Harmony Switch

1. Press [HARMONY] button. The LCD displays “OFF”, which indicates the harmony effect is turned off now.
2. When the LCD displays “OFF”, repeat the previous operation. The LCD now displays “Duet”, which indicates the harmony effect is open, and the type is Duet.
3. To choose a different harmony type, please refer to the harmony setting in function menu.

## Play with Harmony Effect

Open the A.B.C., first play a chord, then play notes in right hand section, the notes played in main voice will be added with the harmony effect.

### **Note:**

The harmony types of 1+5, Octave, Echo, Tremolo, Trill will respond whether the A.B.C. is open or not. Other types of harmony will respond only when the A.B.C. is open.

HARMONY

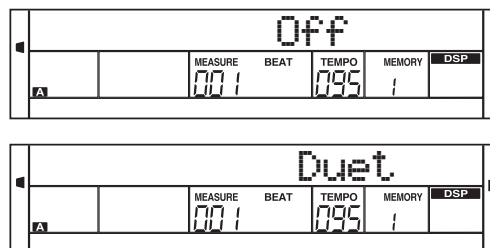
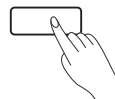

# Performance Assistant

There are 2 voices you can select to perform in performance assistant mode: Guitar, Piano.

## What's the performance assistant?

Performance assistant is an easy-to-use function. With this function you will find playing to be more interesting. Even if you are not a keyboard player, the performance assistant will help you to play your familiar instrument voice on the keyboard. If you're a pianist, you can easier to achieve many hard perform skills on the keyboard with the help of this function.

Performance assistant will provided many wonderful phrases. Just use several keys and you will perform your own wonderful music.

## Enter the Performance Assistant

1. Holding down [SHIFT] button, and then press [PERFROM] button you can enter the performance assistant mode. The default setting is Guitar Mode and the LCD will display Guitar's voice name.
2. You can use the Data Dial, [+ / YES] or [- / NO] button to change the voice you want to perform.
3. In the measure field in LCD, the "4-4" will be displayed. It means the default beat value is the 4/4 and you can change the beat value you want in function menu. Please refer to Performance Beat setting in function menu. You can choose the beat between 2/4, 3/4, 4/4, and 6/8 beat.
4. In Performance Assistant mode, use [TEMPO+] or [TEMPO-] to change the tempo.

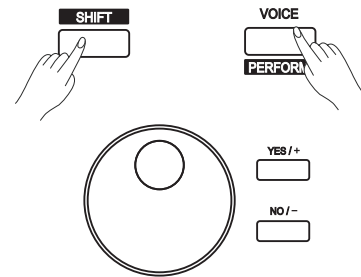

## Guitar Mode

### Guitar key map

The Guitar Mode makes you perform a guitar voice with keyboard just like you're playing a real guitar. In this mode you can use some perform skills like strum (5), broken chord (5), echoism (5) and also 2 endings.

### Chord part

A0 to B3 is the chord part area. Play a chord in this area.

### Sub Area 1

C4 to B4 (only white keys) is the sub area 1. 5 types of broken chord are provided in this area.

### Sub Area 2

The 6 keys: C5 to A5 (only white keys) is just like real guitar's 6 strings. Play a free solo in this area.

### Rhythm Area

C6 to G6 (only white keys) is the rhythm area. Wonderful styles and strums are provided in this area. Use A6 to B6 to play an ending.

### Position Change

Press C7, the guitar voice will be changed to a high position.

### Note:

The keys above C7 doesn't respond in this mode.

Guitar Key map

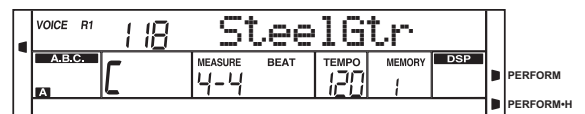
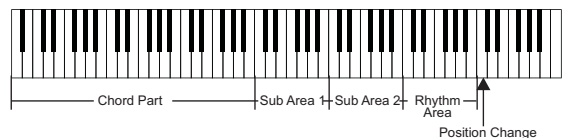

## Playing in Guitar Mode

### Play a chord in the chord part.

A chord type will be displayed on the LCD and the guitar root note will be sounded.

### Play a broken chord in the sub area 1.

When the chord type displayed, press a white key in the sub area 1, a wonderful broken chord phrase will start. Try to change the white key and you will hear some different type of phrase. Change the chord with your left hand; you will hear the broken chord phrase has a little bit change.

### Play a free solo in the sub area 2.

When the chord type displayed, press a white key in the sub area 2 you can play guitar free solo, sounds like you're playing a real one. Try to change the chord with your left hand, and play your free solo. The last white key B5 is invalid.

### Play a strum rhythm in the rhythm area.

When the chord type displayed, press a white key in the rhythm area you can play the magic strum rhythm. Try to change the chord with your left hand, and play your strums.

### End the guitar performing.

Press the A6 or B6 to end your guitar performs. When the ending is finished, the phrase stops automatically.

### Play the echoism.

All of black keys on Sub area 1, Sub area 2 and Rhythm area are echoism keys. There are 5 kinds of echoism to arrange on the C#, D#, F#, G#, A# circularly.

### Change the position

Press the C7, the PERFORM.H icon will be lightened on the LCD. It means that the guitar position has been changed to the High position. Try to play the white keys in sub area 1, Sub area 2 and Rhythm area, listen to the phrase you are performing now.

## Piano Mode

### Piano Key Map

In Piano Mode, you can easily to achieve many hard piano perform skills just like playing the acoustic one. In this mode you can use some perform skills like piano rhythm (5), broken chord (5) and also 3 endings.

The piano key map is similar with the guitar key map. Press A6 to C7(white keys) will start an ending. All the black keys above C4 are invalid.

## Playing in Piano Mode

### 1. Select Piano Mode.

In performance assistant mode, use data dial,[+]/YES] or [-/NO] button to select Piano Mode.

### 2. Play a chord in chord part. Play some phrases in Sub area and Rhythm area.

### 3. Press the A6,B6 or C7 to ending your piano perform. When the ending is finished, the phrase stops automatically.

## Exit the Performance Assistant

When the phrase stops, press the [VOICE], [STYLE], [SONG], [DEMO], [SHIFT]+[PERFORM] to exit the Performance Assistant mode.

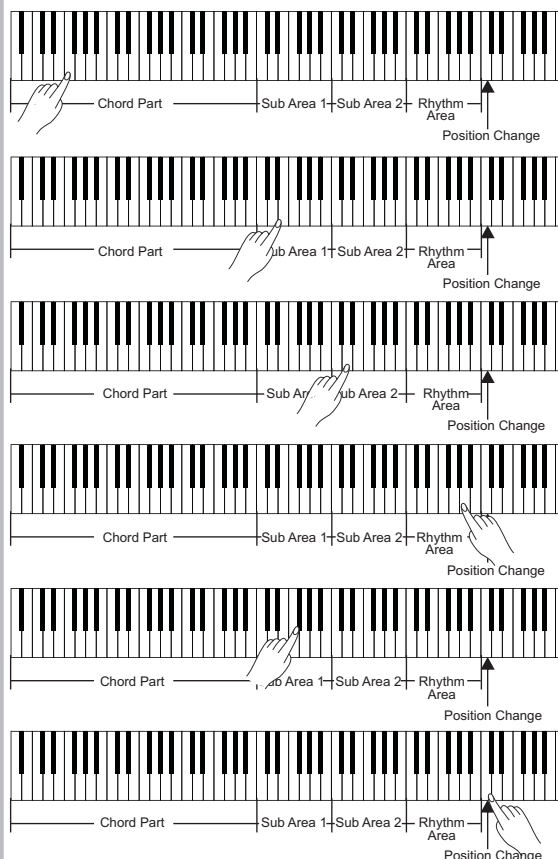
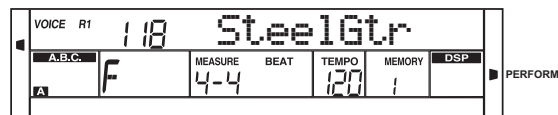

Piano Key map

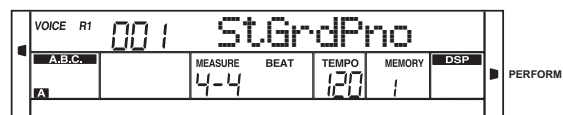
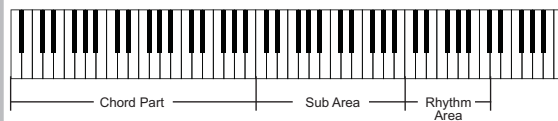

# DSP Effect

With the built in digital effects, you can add ambiance and depth to your music in a variety of ways such as adding reverb that makes you sound like you are playing in a concert hall or adding harmony notes for a full, rich sound.

1. The DSP effect is set to ON and the icon on the LCD is lightened when keyboard is power on. The chorus and reverb value can be adjusted in the function menu.
2. Holding down [SHIFT] button, and then press the [DSP] button to turn DSP effect on or off.

**Note:**

It may cause a break or a noise while switching on/off the DSP when style and song playing. This is normal and need not panic.



# Mixer

Mixer function can control the volume of different tracks.

1. Holding down [SHIFT] button, and then press the [RHYTHM] button to set the Rhythm track volume. LCD displays "Rhythm" and the track volume.
2. When the LCD displays "Rhythm" , use the data dial or the [+ /YES] / [- /NO] button to adjust the value. Pressing [+ /YES] and [- /NO] button simultaneously can turn off/on a track volume.
3. The volume of other tracks such as Bass, Chord, Lower, and Upper can be set the same to Rhythm track.

**Note:**

In voice R1 setting status, the [UPPER] button adjusts the main voice volume. In voice R2 setting status, the [UPPER] button adjusts the R2 voice volume.

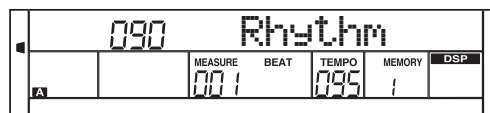

The option and parameters are as follows:

LCD Display	Range
Rhythm: xxx	0 - 127
Bass: xxx	0 - 127
Chord: xxx	0 - 127
Lower: xxx	0 - 127
Upper: xxx	0 - 127

# Pedal Function

The sustain pedal is a single pedal which can be configured to different pedal function. Please refer the pedal setting menu for detail.

## 1. Sustain Pedal(Pedal Sust)

If assign pedal is set as "Pedel Sust", step on the assign pedal, all notes played on the keyboard will have a longer sustain

## 2. Pedal Start/Stop(Pedal St/T)

If pedal assign is set as "Pedal St/T", the assign pedal will have the same function as [START/STOP] button.

## 3. Pedal Memory Select(Pedal Mem)

If pedal assign is set as "Pedal Mem", it will load the next memory parameter from M1 when you step on the pedal.  
The total number of memory you can load is 32.

001 Pedal Sust					
	MEASURE	BEAT	TEMPO	MEMORY	DSP
A	001		01	1	

002 Pedal St/T					
	MEASURE	BEAT	TEMPO	MEMORY	DSP
A	001		01	1	

003 Pedal Mem					
	MEASURE	BEAT	TEMPO	MEMORY	DSP
A	001		01	1	



# Function Menu

Holding down [SHIFT] button, and then press [FUNCTION</>] button to enter function menu. The LCD displays the current function menu option. Use [+ /YES] / [- /NO] or data dial to set parameter of the current menu.

The option and parameters are as follows:

No.	LCD display	Range	Default
1	xxx Tune	-50 ~ +50	000
2	xxx KeySplit	1 ~ 88	034
3	xxx BeatType	0, 2 ~ 9	004
4	xxx MetroVol	0~127	080
5	00x Pedal xxxx	Sust,St/T, Mem	Sust
6	xxx ReverbVol	0 ~ 127	Depend on voice
7	xxx ChorusVol	0 ~ 127	Depend on voice
8	xxx xxxx	Duet, StandardTrio, Full Chord, Rock Duet, Country Duet, Country Trio, Block, 4 Close 1, 4 Close 2, 4 Open, 1+5, Octave, Strum, Echo, Tremolo, Trill	Duet
9	xxx HarmonySpeed	1 ~ 4	1
10	xxx Midi In	1 ~ 16, ALL	ALL
11	xxx Midi Out	1 ~ 16	001
12	xxx PowerOff	OFF, 30,60	030
13	xxx Perform Beat	4-4, 3-4, 2-4, 6-8	4-4

## Note:

The function menu status will exit if no operation is done within 5 seconds.

## Tune

This function sets the pitch of entire keyboard by steps of cents.

1. Holding down [SHIFT] button, and then press [FUNCTION</>] button to select tune menu. LCD displays "xxx Tune". Use [+ /YES] / [- /NO] or data dial to change tune value. Its range is from -50 to 50 cents.
2. Press [+ /YES] and [- /NO] simultaneously will set the tune value to its default setting:000. The setting is applied to both accompaniment and the voice.

## KeySplit

This function sets the point which separates the entire keyboard to two sections.

1. Holding down [SHIFT] button, and then press [FUNCTION</>] button to select keysplit menu. LCD displays "xxx KeySplit". Use [+ /YES] / [- /NO] or data dial to change keysplit value. The range of keysplit: 1~88.
2. Press [+ /YES] and [- /NO] simultaneously will set the keysplit value to its default setting: F#3(34).

## Note:

When twinova is opened, the range of keysplit is C3~C6 (28~64). Press [+ /YES] and [- /NO] simultaneously will set twinova keysplit value to its default setting: E3(32).

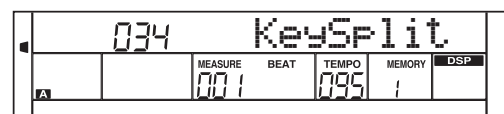

# Function Menu

## Beat Type

1. Holding down [SHIFT] button, and then press [FUNCTION</>] button to select beat type menu. LCD displays "xxx BeatType". Use [+ / YES] / [- / NO] or data dial to change beat type. The range of beat type: 0, 2~9.
2. Press [+ / YES] and [- / NO] simultaneously will set the beat type value to its default setting: 004.



## Metro Volume

1. Holding down [SHIFT] button, and then press [FUNCTION</>] button to select beat volume menu. LCD displays "xxx MetroVol". Use [+ / YES] / [- / NO] or data dial to change beat volume. The range of beat volume: 0~127.
2. Press [+ / YES] and [- / NO] simultaneously will set the beat volume value to its default setting: 090.

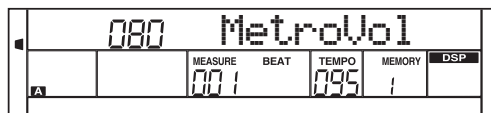

## Pedal Type

1. Holding down [SHIFT] button, and then press [FUNCTION</>] button to select pedal type menu. LCD displays "00x Pedal xxxx". Use [+ / YES] / [- / NO] or data dial to change pedal type. 3 types of pedal are available: sustain pedal(Sust), accompaniment start/stop Pedal(St/T), memory switch pedal(Mem).
2. Press [+ / YES] and [- / NO] simultaneously will set the pedal type to its default setting: Sust.



## Reverb Volume

1. Holding down [SHIFT] button, and then press [FUNCTION</>] button to select reverb volume menu. LCD displays "xxx ReverbVol". Use [+ / YES] / [- / NO] or data dial to change reverb volume. Range: 0~127
2. Press [+ / YES] and [- / NO] simultaneously will set the reverb volume to its default setting.



### Note:

The reverb volume default value depends on the voice.

## Chorus Volume

1. Holding down [SHIFT] button, and then press [FUNCTION</>] button to select chorus volume menu. LCD displays “xxx ChorusVol”. Use [+ /YES] / [- /NO] or data dial to change chorus volume. Range: 0~127
2. Press [+ /YES] and [- /NO] simultaneously will set the chorus volume to its default setting.

### Note:

The chorus volume default value depends on the voice.

## Harmony Type

1. Holding down [SHIFT] button, and then press [FUNCTION</>] button to select harmony type menu. LCD displays “xxx xxx”. Use [+ /YES] / [- /NO] or data dial to change harmony type.

The harmony types are as follows:

Number	LCD Display
1	Duet
2	StandardTrio
3	Full Chord
4	Rock Duet
5	Country Duet
6	Country Trio
7	Block
8	4 Close 1
9	4 Close 2
10	4 Open
11	1+5
12	Octave
13	Strum
14	Echo
15	Tremolo
16	Trill

2. Press [+ /YES] and [- /NO] simultaneously will set harmony type to default setting: Duet.
3. When the harmony type is echo, tremolo or trill, the speed of harmony effect note can be adjusted. Please refer to the harmony speed setting.
4. When the harmony type is strum, echo, tremolo or trill, the tempo setting will also change the harmony note speed.

## Harmony Speed

When the harmony type is echo, tremolo or trill, the harmony speed can set the harmony effect note speed to 4 default speed.

1. Holding down [SHIFT] button, and then press [FUNCTION</>] button to select harmony speed menu. LCD displays “xxx HarmonySpeed”. Use [+ /YES] / [- /NO] or data dial to change harmony speed. Range: 1~4.
2. Press [+ /YES] and [- /NO] simultaneously will set the chorus volume to its default setting: 001.

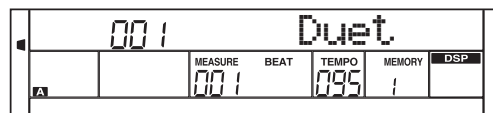

# Function Menu

## MIDI IN

1. Holding down [SHIFT] button, and then press [FUNCTION</>] button to select MIDI in menu. LCD displays “xxx Midi In”. Use [+ /YES] / [- /NO] or data dial to change MIDI in channel:1~16, ALL.
2. Press [+ /YES] and [- /NO] simultaneously will set MIDI in channel to its default setting: ALL.

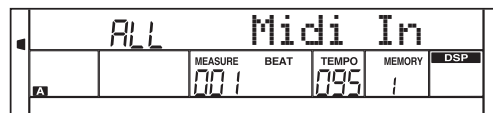

## MIDI OUT

1. Holding down [SHIFT] button, and then press [FUNCTION</>] button to select Midi Out menu. LCD displays “xxx Midi Out”. Use [+ /YES] / [- /NO] or data dial to change Midi Out channel: 1~16.
2. Press [+ /YES] and [- /NO] simultaneously will set Midi Out channel to its default setting: 001.

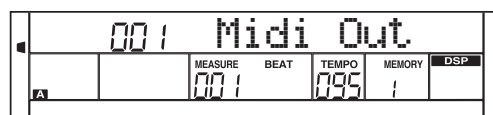
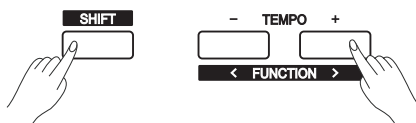

## Power Off

This function is used to set automatic shutdown time.

1. Press [FUNCTION</>] button to select power off menu. LCD displays “xxx PowerOff”. Use [+ /YES] / [- /NO] or data dial to change time value: OFF, 030, 060.
2. Press [+ /YES] and [- /NO] simultaneously, the time will be restored to default: 030 (30 minutes).

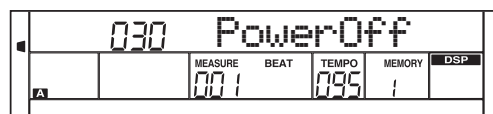

## Performance Beat Type

This function is used to set the performance assistant beat type.

1. Holding down [SHIFT] button, and then press [FUNCTION</>] button to select Perform Beat menu. LCD displays “xxx Perform Beat”. Use [+ /YES] / [- /NO] or data dial to change performance beat: 4-4, 3-4, 2-4, 6-8.
2. Press [+ /YES] and [- /NO] simultaneously will set performance beat channel to its default setting: 4-4.



# Restore Factory Setting

Pressing and holding [+ / YES] and [- / NO] button together and then turn the power on, the piano would be restored to factory setting. It will delete all the user data: user styles, user songs and registered memory. The LCD will display "Loading.". After the restore completed, the piano will start normally.

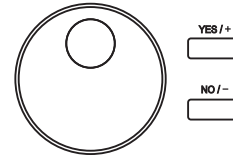

# Register Memory

The keyboard is an instrument with a variety of controls and functions, the Registration Memory feature can make your performance more easily and efficiently. It allows you to save virtually all panel settings to a Registration Memory setting, and you can instantly recall custom panel settings by pressing a single button.

## Registering the Panel Setting

1. There are 8 memory banks, and each bank has 4 memories (M1-M4).
2. Holding down the [STORE] button, press one of the registration memory buttons: [M1] - [M4]. Notice that the new settings will replace the previous memory data.

### Note:

Press [STORE] and [M1] button then power on, the registration memory will be set to default.

## Recalling the Registered Panel Settings

Press one of the registration memory buttons: [M1] - [M4]. In this example, the panel settings stored in the memory 2 of bank 1 are recalled.

### Note:

Registration data cannot be recalled when the One Touch Setting function is on.

## Selecting a Registration Bank

1. Press the [BANK] button. There are 8 banks in all and each bank has 4 memories (M1-M4). Press the [BANK] button, the LCD displays "Mem Bank".
2. Select a bank. Use the data dial, [+ / YES] or [- / NO] button to select a bank from 1 to 8.

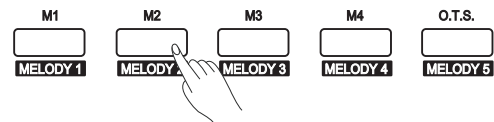
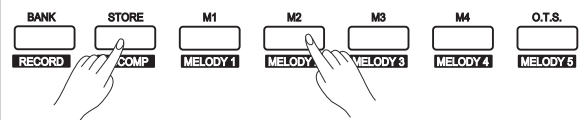

# Register Memory

## Accompaniment Freeze

When the freeze function is turned on, the parameters about accompaniment (style number, accompaniment section, accompaniment volume, tempo, transpose, chord status, mixer, key split point) will not change when recalling a registered memory.

1. Press the [FREEZE] button, the LCD will display FREEZE indicate. Now the accompaniment parameters would not be changed when recalling registered memory.
2. In freeze status, press the [FREEZE] button. The freeze function is turned off. The freeze indicate on LCD will light off.



# Song Album

The piano has Song Album function. It presets 120 album songs parameter, which includes style type, tempo, and voice. You can play the preset song using song album function using the parameter in accordance with that song. Please refer to appendix for album list.

1. Holding down [SHIFT] button, and then press [ALBUM] button can turn the album function on or off.
2. When the album function is on, LCD displays the album song name and the indicate of album. Now use the data dial, [+ / YES] or [- / NO] button can select the song to play. The piano will adjust the accompaniment parameters to fit that song.
3. Press voice direct button or style direct button can exit the album function.



With the easy-to-use song recording features, you can record your own keyboard performances as a user song. 10 user songs can be recorded with 6 tracks (1 ACCOMP track, 5 MELODY tracks) each.

Among them, the accompaniment track is used for recording style and this recorded track is user song's accomp. Melody tracks are used for recording melodies.

Accomp track and melody track can be recorded together, but you cannot record two melody tracks at the same time. Of course you can only record accomp or melody; Accomp and several melody tracks can simultaneous playback. The recorded data will not lose when you turn off the power.

## Start Recording

Before you start recording, you need to select a user song to keep the recording song, and set the recording tracks.

1. Holding down [SHIFT] button, and then press the [RECORD] button to enter user song selection mode. The LCD displays "RecSong1" and sequence number.

Use the data dial, [+ / YES] or [- / NO] button select the user song you want to record.

2. Holding down [SHIFT] button, and then press the [RECORD] button again to enter record preparation mode. LCD lightens the "REC" flag, and LCD will flash beat indicate. The piano will automatically select a empty track to record your performance.

The LCD indicate in the below which flashes shows the record track.

3. In the recording preparation status, you can adjust parameters such as the voice, style and tempo. When recording a new song, it will automatically select "Melody 1" as the recorded track.

Holding down [SHIFT] button, and then press "ACCOMP" (or "MELODY1" to "MELODY 5") to make your own selection.

The ACCOMP track and one of MELODY track can be recorded at the same time, but it cannot record two MOLODY track simultaneously.

4. Press [START/STOP] button or play the keyboard to start recording. When choosing the accomp tack and A.B.C. is open, play an effective chords in left hand section or press [START/STOP] button would start recording.

### Note:

Style can only be recorded in "Accomp" track. The recording track LCD indicate has three states: Blinking, Light, Go out.

**Blinking:** It means the track was chose for recording. If the track have recorded data, the original data will be replaced.

**Light:** It means this track have data, the recording process will record data with playback the recorded track at the same time.

**Go out:** It means this track has no data or has data which can not playback when recording.

When recording an existing song, the keyboard will automatically select the empty track next to the occupied track. For example, if "Melody 1" is occupied, then "Melody 2" will be selected as the record track. When all 6 tracks have been recorded and a specific track needs to be revised, press the button of that track and start recording. The original data will be replaced.

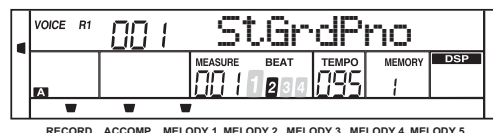
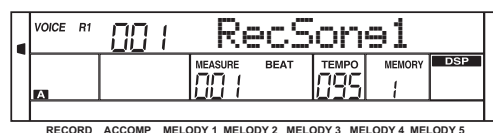

# Song Recording

## Stop Recording

1. When recording is in process, holding down [SHIFT] button and then press the [RECORD] button to stop recording.
2. When recording is in process, if the memory is full, the recording will stop and save automatically, and the LCD displays "Rec\_Full".
3. If you choose the accomp recording, the recording will stop automatically when the ending of the rhythm finishes.

## Playback Recording

1. When recording is in process, holding down [SHIFT] button and then press the [RECORD] button, it will stop recording and enter the song play mode, and the current recorded song will play automatically in circle.
2. Press the [SONG] button to enter the song mode and it will play all songs circularly. Use the data dial, [+ / YES] or [- / NO] button to select a song, there are 70 songs in all, including 10 user songs (61~70). If there is no data in the selected user song, it will display "NoFile" and stop playing.
3. You can select one user song in song stop playing mode, press [PLAY/STOP] button, this user song will play circularly.

## Delete User Song

1. Pressing and holding [RECORD] and [SONG] button together and turn power on simultaneously, all user songs will be erased.
2. In the recording preparation status, holding down [SHIFT] button and then press the [RECORD] button for two second, the LCD will display "Delete?". Holding down [SHIFT] button then press [ACCOMP] (or [MELODY 1] to [MELODY 5]) button to select the track you want to delete.  
When some track indicate is lightened, it indicates that the track data you want to delete, otherwise, it indicate that the track data you want to keep. If all the track indicates are lightened, the whole user song will be erased after confirmation.
3. Choose the track you want to delete, press [+ / YES] to confirm and the recorded data in this track will be erased. Press [- / NO] to quit this step, and go back to the recording preparation status

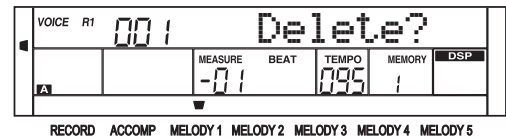
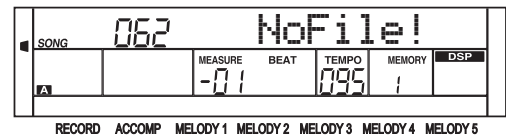
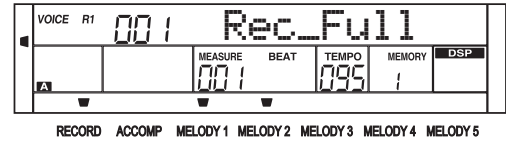



The piano has 70 songs in all, including 10 user songs.

## Listen to the songs

1. Press the [SONG] button to enter the song mode. The LCD shows "SONG" indicate and it will play all songs circularly.
2. Use the data dial, [+ / YES] or [- / NO] button to select a song.
3. Once you start playing a song by pressing [▶ / ■] button, it will play current song repeatedly.
4. When the song is stopped, press the style or voice direct button, [DUAL] button and so on will exit the song mode.

## Song Control

1. Introductory beat  
Before song start playing, it has the introductory beat, the measure starts from negative value. It begins to play song when the measure goes to 1.
2. REW, FF and PAUSE  
When the song is playing:  
Press the [▶▶] button to fast forward the song.  
Press the [◀◀] button to rewind the song (base on the measure).  
Press the [||] button to pause the playing song.
3. Song Repeat  
When playing the song, press the [↺] to set the loop begin and press it again to set the loop end. When in loop status, press [↺] again to quit the loop playing status.

## Practice Song

In the song stops playback state [MELODY OFF] button to enter the Melody off mode. The LCD display "R" signs lit. Said closing songs right hand melody, press [start / stop] button Began to play songs will only the left hand accompaniment sound.

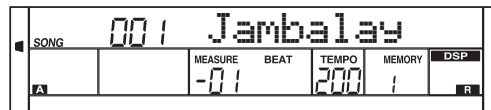
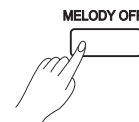
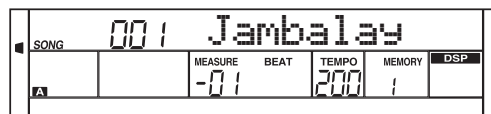

# MIDI

With the MIDI functions you can expand your musical possibilities. This section will let you know what MIDI is, and what it can do, as well as how you can use MIDI on your instrument.

## What's MIDI?

MIDI (short for Musical Instrument Digital Interface) allows a wide variety of electronic musical instruments, computers and other related devices to connect and communicate with one another. MIDI carries event messages that specify notation, pitch and velocity, control signals for parameters such as volume, vibrato, audio panning, and program change information to change the voice selections.

The instrument can output the real-time playback information via MIDI and control external MIDI devices. The instrument can also accept incoming MIDI messages and generate sound accordingly.

This piano has a USB port, which can be connected to a PC as an MIDI input or MIDI output.

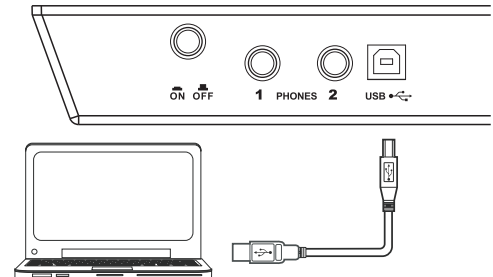

## Upload/Download Data from the Computer

1. Connect a standard USB cable between the rear-panel USB jack on the instrument and the USB jack on your computer.
2. Power on the piano first, and then open the PCSUITE software in your computer. If the LCD displays "PCLink.." it indicates the piano connects the PC successfully.
3. You can download 10 MIDI files to the keyboard as user songs or upload the user songs to PC.
4. You can upload user styles to the computer as a backup or download them to the keyboard. You can upload memory files to the computer as a backup or download them to the keyboard.
5. Please refer to software operation instructions for detail operating methods.

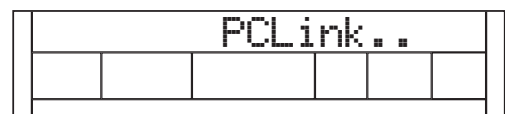

# Troubleshooting

Problem	Possible Cause and Solution
The speakers produce a “pop” sound whenever the power is turned ON or OFF.	This is normal and is no cause for alarm.
No sound when the keyboard is played.	The R1/R2/L voice volume (Mixer) settings could be set too low. Make sure the voice volumes are set at appropriate levels.
When using a mobile phone, noise is produced.	Using a mobile phone in close proximity to the instrument may produce interference. To prevent this, turn off the mobile phone or use it further away from the instrument.
The auto accompaniment does not play back even Sync is in standby condition and a key is pressed.	You may be trying to start accompaniment by playing a key in the right-hand range of the keyboard. To start the accompaniment with Sync Start, make sure to play a key in the left-hand range of the keyboard.
Certain notes sound at wrong pitch.	Make sure that the tuning value is set to “0” . Press and hold the [+ /YES] and [- /NO] buttons at the same time, then turning the power on will set INSTRUMENT to default.
The Harmony function does not operate.	Harmony cannot be turned on when a drum kit is selected for the voice R1.

# Specifications

## LCD Display

Multifunctional LCD

## Keys

88 Hammer-Action Keys

## Polyphony

128

## Voices

500

## Songs

70, including 10 user songs

## Styles

210, including 10 user styles

## Demos

5

## Control button

Power Switch, Volume Knob, Brilliance Knob, Style direct buttons(Mixer buttons), Tempo+/(Function+/-), Shift, Melody Off, Voice(Perform), Style(Demo), Song(Album), Yes/+, No/-, Voice direct buttons(Piano), Metronome, Dual, Lower, Touch, Dsp, Transpose+/-), Scale, Twinova, Octave, Bank, Store, M1-M4, O.T.S., Accomp+/-, Data dial, Freeze, Harmony.

## Accompaniment/Song Control

Start/Stop, Sync Start(Pause), Intro/Ending(Repeat A/B), Fill A(REW), Fill B(FF), Chord Mode

## Record

Record, Accom track, Melody track 1~5

## Panel Memory

32

## Connectors

DC IN, Headphones, AUX IN, AUX OUT, USB

## Power Supply

DC 15V IN

## Speaker

4ohm 15W X 2

## Dimensions

1388(L)x 308(W)x 788(H)mm

## Weight

37kg

\* All specifications and appearances are subject to change without notice.

# Voice List

No.	Name	LCD Name
<b>Piano</b>		
1	Stereo Grand Piano	StGrdPno
2	Acoustic Grand Piano (wide) 1	GrandPnW
3	Acoustic Grand Piano (dark)	GrandPnD
4	Octave Piano 1	OctPno1
5	Octave Piano 2	OctPno2
6	Piano & Strings	Pno&Str
7	Piano & Choir	Pno&Cho
8	Acoustic Grand Piano	GrandPno
9	Stereo Bright Piano	StBrtPno
10	Bright Acoustic Piano	BritePno
11	Bright Acoustic Piano (wide) 1	BritePnW
12	Chorus Piano	ChoruPno
13	Electric Grand Piano	E.Grand
14	Electric Grand Piano (wide)	E.GrandW
15	Stereo Honk-Tonk	StHonkTo
16	Honky-tonk Piano	HnkyTonk
17	Honky-tonk Piano (wide) 1	HnyTonkW
18	Stereo Hard Electric Piano	StHarEp
19	Detuned Electric Piano 1	DetunEP1
20	Detuned Electric Piano 2	DetunEP2
21	Electric Piano 1	E.Piano1
22	Electric Piano 2	E.Piano2
23	Electric Piano (wide) 1	EPnoW1
24	Electric Piano (wide) 2	EPnoW2
25	EP Legend	EPLegend
26	EP Phase	EPPhase
27	60's Electric Piano	60'sEP
28	Electric Piano 1 (velocity mix)	E.PnoV1
29	Electric Piano 2 (velocity mix)	E.PnoV2
30	Velocity Crossfade Electric Piano	VeCrosEP
31	Layered Electric Piano 1	LayerEp1
32	Layered Electric Piano 2	LayerEp2
33	Nylon Electric Piano	NylonEP
34	Warm Electric Piano	WarmEp
35	Grand Harpsichord	GraHarps
36	Harpsichord 1	Harpsi
37	Harpsichord 2	Harpsi2
38	Harpsichord (wide)	HarpsiW
39	Harpsichord (octave mix) 1	HarpsiO
40	Harpsichord Release	HarpsiR
41	Harpsichord (with key off)	HarpsiOf
42	Clavi 1	Clavi
43	Clavi 2	Clavi2
44	Clavi (wide) 1	ClaviW1
45	Clavi (wide) 2	ClaviW2
46	Clavi Wah	ClaviWa
47	Pulse Clavi	PluseClv
<b>Chromatic Percussion</b>		
48	Celesta 1	Celesta
49	Celesta 2	Celesta2
50	Birght Celeasta	BirCelea
51	Celesta & Sine	Celes&Si
52	Reecho Bell	RechBell
53	Celesta & Music Box	Celes&MB
54	Glockenspiel 1	Glocken

55	Glockenspiel 2	Glocken2
56	Music Box 1	MusicBox
57	Music Box 2	MusicBo2
58	Music Box 3	MusicBo3
59	Toy Box	ToyBox
60	Music Box & Harp	Mbx&Harp
61	Stereo Vibrapho	StVibes
62	Rigid Vibraphone	RigiVibe
63	Vibraphone 1	Vibra
64	Vibraphone 2	Vibra2
65	Vibraphone (wide) 1	VibraW
66	Vibraphone (wide) 2	VibraW2
67	Vibraphone & Bell	Bell&Vib
68	Marimba 1	Marimba
69	Marimba 2	Marimba2
70	Marimba (wide)	MarimbaW
71	Stereo Marimba	StMarim
72	Marimba & Vibraphone	Mar&Vib
73	Xylophone 1	Xylophon
74	Xylophone 2	Xylopho2
75	Tubular Bells	TubulBel
76	Church Bell	ChurBell
77	Carillon	Carillon
78	Dulcimer	Dulcimer
79	Santur	Santur
<b>Organ</b>		
80	Drawbar Organ 1	DrawOrgn
81	Drawbar Organ 2	DrawOrg2
82	Soft Stereo Drawbar Organ	SfDrawOr
83	Mellow Drawbar Organ	MellDrOr
84	Detuned Drawbar Organ 1	DeDraOrg
85	Detuned Drawbar Organ 2	DeDraOr2
86	Italian 60's Organ	60'sOrgn
87	1970 Percussive Organ	1970PcOr
88	Percussive Organ 1	PercOrgn
89	Percussive Organ 2	PercOrg2
90	Light Click Organ	LClickOr
91	Detuned Percussive Organ	DePerOrg
92	Stereo Rotary Organ	StRotaOr
93	Rock Organ	RockOrgn
94	Rotary Organ	RotaOrgn
95	Slow Rotary Organ	SloRotOr
96	Detuned Church Organ	DeChuOrg
97	Church Organ 1	ChurOrgn
98	Church Organ 2	ChurOrg2
99	Church Organ (octave mix)	ChurOrgO
100	Reed Organ	ReedOrgn
101	Puff Organ	PuffOrgn
102	Accordion 1	Acordion
103	Accordion 2	Acordin2
104	Accordion 3	Acordin3
105	Mustte	Mustte
106	Accord It Solo	AccordSo
107	Sweet Harmonica	SwetHarm
108	Harmonica 1	Harmnica
109	Harmonica 2	Harmnic2
110	Tango Accordion	TangoAcD

Guitar		
111	Acoustic Guitar (nylon) 1	NylonGtr
112	Acoustic Guitar (nylon) 2	NylonGt2
113	Acoustic Guitar (nylon + key off)	NylGtrOf
114	Ukulele	Ukulele
115	Velocity Nylon Guitar	NylnGtVe
116	Chorus Nylon Guitar	ChoNyGt
117	Bright Nylon Guitar	BrNyGt
118	Acoustic Guitar (steel) 1	SteelGtr
119	Acoustic Guitar (steel) 2	SteelGt2
120	Steel Guitar with Body Sound	SteelBdy
121	Tremolo Steel Guitar	TremGt
122	Mandolin	Mandolin
123	12-Strings Guitar	12StrGtr
124	Chorus Steel Guitar	ChoSteGt
125	Nylon & Steel Guitar	Ny&SteGt
126	Stereo Steel Guitar	StSteGt
127	Steel Guitar Bend	GtBend
128	Steel Guitar Harmonics	GtHarm
129	Velocity Steel Guita 1	VelSte1
130	Velocity Steel Guita 2	VelSte2
131	Velocity Steel Guita 3	VelSte3
132	Electric Guitar (jazz) 1	JazzGtr
133	Electric Guitar (jazz) 2	JazzGt2
134	Electric Guitar (pedal steel)	PedalGtr
135	Mellow Guitar	MelloGt
136	Velocity Jazz Guitar	JazzGtVe
137	Jazz Guitar Detuned	JazzGtDt
138	Mid Tone Guitar	MidTonGt
139	Electric Guitar (clean) 1	CleanGtr
140	Electric Guitar (clean) 2	CleanGt2
141	Stereo Clean Guitar	StCleGtr
142	Velocity Clean Guitar	CleGtVel
143	Electric Guitar (detuned clean)	DetClnGt
144	Electric Guitar (muted velo-sw)	MutVelGt
145	Electric Guitar (muted)	MutedGtr
146	Electric Guitar (funky cutting)	FunkGt
147	Jazz Man	JazzMan
148	Stereo Muted Guitar	StMuGt
149	Guitar Pinch	GtPinch
150	Overdriven Guitar	Ovrdrive
151	Distortion Guitar 1	DistGtr
152	Distortion Guitar 2	DistGt2
153	Distortion Guitar (with feedback) 1	FeedbkGt
154	Distorted Rhythm Guitar	DistRyth
155	5th Distortion	5thDist
156	Stereo Distorted Guitar	StDistor
157	Guitar Feedback	GtrFedbck
158	Guitar Harmonics	GtrHarmo
Bass		
159	Acoustic Bass 1	AcoBass
160	Acoustic Bass 2	AcoBass2
161	Jazz Style	JazzSty
162	A.Bass & Mute G.T.	Bs&GtMu
163	Resonant Bass	ResBass
164	Wah Bass 1	WahBass1
165	Electric Bass (finger) 1	FngrBass

166	Electric Bass (finger) 2	FngrBas2
167	Electric Bass (finger) 3	FngrBas3
168	Finger Slap Bass	FngrSlap
169	Wah Finger Bass	WahFnBs
170	Electric Bass (pick) 1	PickBass
171	Electric Bass (pick) 2	PickBas2
172	Mute Pick Bass	MuPkBass
173	Fretless Bass 1	Fretless
174	Fretless Bass 2	Fretlss2
175	Slap Bass 1	SlapBas1
176	Slap Bass 2	SlapBas2
177	Slap Bass 3	SlapBas3
178	Slap Bass 4	SlapBas4
179	Synth Bass 1	SynBass1
180	Synth Bass 2	SynBass2
181	Synth Bass 3 (resonance)	ResoBass
182	Synth Bass 4 (attack)	AtackBas
183	Synth Bass (warm)	WarmBass
184	Clavi Bass	ClavBass
185	Hammer	Hammer
186	Synth Bass (rubber)	RubbBass
187	Attack Pulse	AtackPls
Strings & Orchestral Instruments		
188	The Violin	TheVin
189	Violin 1	Violin
190	Violin 2	Violin2
191	Violin (slow attack)	SlViolin
192	Soft Violin	SoftVin
193	Viola 1	Viola
194	Viola 2	Viola2
195	Viola 3	Viola3
196	Cello 1	Cello
197	Cello 2	Cello2
198	Celloen 16'	Celloen
199	Chamber Music	Chamber
200	Contrabass 1	Contrabs
201	Contrabass 2	Contrbs2
202	Tremolo Strings 1	TremStr
203	Tremolo Strings 2	TremStr2
204	Slow Tremolo Strings 1	SlwTrSt1
205	Slow Tremolo Strings 2	SlwTrSt2
206	Pizzicato Strings 1	PizzStr
207	Pizzicato Strings 2	PizzStr2
208	Octave Pizzicato	OctoPizz
209	Orchestral Harp 1	Harp
210	Orchestral Harp 2	Harp2
211	Yang Chin	YangChin
212	Timpani 1	Timpani
213	Timpani 2	Timpani2
Ensemble		
214	The Strings	TheStr
215	String Ensembles 1	Strings1
216	String Ensembles 2	Strings2
217	Synth Strings 1	SynStrs1
218	Synth Strings 2	SynStrs2
219	Synth Strings 3	SynStrs3
220	Synth Strings 4	SynStrs4

# Voice List

221	Synth Strings 5	SynStrs5
222	Resonant Strings	ResonSt
223	Stereo Slow Strings	SSlowStr
224	Slow Strings	SlowStr
225	Strings and Brass	Str&Bras
226	Legato Strings	LegatStr
227	Orchestra	Orchstr
228	Arco Strings	ArcoStr
229	60's Strings	60'sStr
230	1970 Strings	70'Str
231	Solo Strings	SoloStr
232	Choir Aahs 1	ChoirAah
233	Choir Aahs 2	ChoirAh2
234	Choir Aahs 3	ChoirAh3
235	Stereo Choir Aahs	StChoir
236	Strings & Choir	StrChoir
237	Humming	Humming
238	Voice Oohs	VoiceOoh
239	Analog Voice	AnaVoice
240	Synth Voice	SynVoice
241	Bass Hit Plus	BassHit
242	Orchestra Hit 1	OrchHit
243	Orchestra Hit 2	OrchHi2
244	Euro Hit	EuroHit
245	6th Hit	6thHit
<b>Brass</b>		
246	Trumpet 1	Trumpet
247	Trumpet 2	Trumpet2
248	Trumpet 3	Trumpet3
249	Dark Trumpet Soft	DarkTrp
250	Sweet Trumpet	SweetTp
251	Wah Trumpet	WahTp
252	Trombone 1	Trombone
253	Trombone 2	Trmbone2
254	Bright Trombone	BritBone
255	Strings & Trombone	Str&Trb
256	Tuba 1	Tuba
257	Tuba 2	Tuba2
258	Soft Tuba	SoftTuba
259	Muted Trumpet 1	MuteTrp1
260	Muted Trumpet 2	MuteTrp2
261	French Horn 1	FrHorn
262	French Horn 2 (warm)	FrHorn2
263	French Horn 3	FrHorn3
264	Stereo French Horn	StFrHorn
265	Horn Orchestra	5thHornO
266	Brass Section 1	Brass
267	Brass Section 2 (octave mix)	Brass2
268	Brass Section 3	Brass3
269	Brass Section 4	Brass4
270	Brass Section 5	Brass5
271	Brass Swell	BrasSwel
272	Brass Band	BrasBand
273	Bright Brass Section	BrBraSec
274	Mute Brass Ensemble	MuteEns
275	Sforzato Brass	SfrzBras
276	Brass & Strings	Bras&Str

277	Synth Brass 1	SynBras1
278	Synth Brass 2	SynBras2
279	Synth Brass 3	SynBras3
280	Synth Brass 4	SynBras4
281	Analog Synth Brass 1	AnaBras1
282	Analog Synth Brass 2	AnaBras2
283	Jump Brass	JumpBras
284	Octave Synth Brass	SynBraOc
285	Synth Brass & Strings 1	SyBr&St1
286	Synth Brass & Strings 2	SyBr&St2
287	Echo Brass	EchoBr
<b>Reed</b>		
288	Soprano Sax 1	SprnoSax
289	Soprano Sax 2	SprnSax2
290	Soprano Sax Soft	SopSaxSf
291	Slow Soprano Sax	SlSopSax
292	Sweet Soprano Sax	SweSpSax
293	Alto Sax	AltoSax
294	Soft Alto Sax	SoftAlto
295	Super Alto Sax	SuprAlto
296	Tenor Sax 1	TenorSax
297	Tenor Sax 2	TenoSax2
298	Baritone Sax	BariSax
299	Sweet Oboe	SwetOboe
300	Oboe 1	Oboe
301	Oboe 2	Oboe2
302	English Horn 1	EngHorn
303	English Horn 2	EngHorn2
304	Woodwinds	Woodwind
305	Bassoon 1	Bassoon
306	Bassoon 2	Basson2
307	Clarinet 1	Clarinet
308	Clarinet 2	Clarinet2
<b>Pipe</b>		
309	Piccolo	Piccolo
310	Flute	Flute
311	Sweet Flute	SweeFlut
312	Recorder	Recorder
313	Sweet Pan Flute	SwPanFu
314	Pan Flute	PanFlute
315	Blown Bottle	Bottle
316	Shakuhachi	Shakhchi
317	Whistle 1	Whistle
318	Whistle 2	Whistle2
319	Ocarina	Ocarina
<b>Synth Lead</b>		
320	Lead 1 (square)	SquareLd
321	Square	Square
322	Lead 1b (sine)	SineLead
323	Square Lead 1	SquarLd1
324	Lead 1a (square 2)	SquarLd2
325	Lead 2a (sawtooth 2)	SawLead2
326	Lead 2d (sequenced analog)	SquAnaLd
327	Lead 2 (sawtooth)	SawLead1
328	Lead 2b (saw + pulse)	SawPlsLd
329	Lead 2c (double sawtooth)	DubSawLd
330	Lead 3 (calliope)	CaliopLd

331	Lead 4 (chiff)	ChiffLd
332	Lead 5 (charang)	CharanLd
333	Lead 5a (wire lead)	WireLead
334	Lead 6 (voice)	VoiceLd
335	Lead 7 (fifths)	FifthsLd
336	Lead 8 (bass + lead)	BassLead
337	Lead 8a (soft wrl)	SftWrlLd
<b>Synth Pad</b>		
338	Pad 1 (new age)	NewAgePd
339	Slow Square	SlowSqu
340	New Year Pad	NewYrPd
341	Pad 2 (warm)	WarmPad
342	PWM Pad	PWMPad
343	Pad 2a (sine pad)	SinePad
344	Horn Pad	HornPad
345	Pad 3 (polysynth) 1	PolySyPd
346	Click Pad	ClickPd
347	Analog Pad	AnaloPad
348	Poly Pad	PolyPad
349	Pad 4 (choir)	ChoirPad
350	Pad 4a (itopia)	ItopiaPd
351	Pad 5 (bowed) 1	BowedPad
352	Pad 6 (metallic) 1	MetalPad
353	Pan Pad	PanPad
354	Pad 7 (halo) 1	HaloPad
355	Pad 7 (halo) 2	HaloPad2
356	Pad 8 (sweep) 1	SweepPad
357	Pad 8 (sweep) 2	SweepPad2
358	Dipolar Pad	DipolPad
359	Rising	Rising
360	Congregate	Congrega
<b>Synth SFX</b>		
361	FX 1 (rain)	FXRain
362	FX 2 (soundtrack)	Soundtrk
363	Progenitor	Progenit
364	FX 3a (synth mallet)	SynMalet
365	FX 3 (crystal)	Crystal
366	FX 4 (atmosphere)	Atmosphr
367	Warm Air	WarmAir
368	FX 5 (brightness)	Bright
369	FX 6 (goblins)	Goblins
370	Choir Bell	ChoirBel
371	FX 7 (echoes) 1	Echoes
372	FX 7a (echo bell) 1	EchoBell
373	FX 7b (echo pan)	EchoPan
374	FX 8 (sci-fi)	Sci-Fi
<b>Ethnic Misc.</b>		
375	Sitar 1	Sitar
376	Sitar 2 (bend)	Sitar2
377	Banjo	Banjo
378	Shamisen	Shamisen
379	Koto	Koto
380	Taisho Koto	TaishoKt
381	Kalimba	Kalimba
382	Bag Pipe	Bagpipe
383	Fiddle	Fiddle
384	Shanai	Shanai

<b>Percussive</b>		
385	Tinkle Bell	TnklBell
386	Agogo	Agogo
387	Steel Drums	SteelDrm
388	Woodblock	WoodBlok
389	Castanets	Castanet
390	Taiko Drum	TaikoDum
391	Concert Bass Drum	ConBasDm
392	Melodic Tom 1	MelodTom
393	Melodic Tom 2 (power)	MelodTom2
394	Synth Drum	SynDrum
395	Rhythm Box Tom	RhythBox
396	Electric Drum	ElecDrum
397	Reverse Cymbal	RevCymb1
<b>SFX</b>		
398	Guitar Fret Noise	FretNoiz
399	Guitar Cutting Noise	GtCtNoiz
400	Acoustic Bass String Slap	BsStSlap
401	Breath Noise	BrthNoiz
402	Flute Key Click	FlKeyClk
403	Seashore	Seashore
404	Rain	Rain
405	Thunder	Thunder
406	Wind	Wind
407	Stream	Stream
408	Bubble	Bubble
409	Bird Tweet 1	Tweet
410	Dog	Dog
411	Horse Gallop	HouseGlp
412	Bird Tweet 2	Tweet2
413	Sheep	Sheep
414	Telephone Ring 1	Telephone
415	Telephone Ring 2	Telphon2
416	Door Creaking	DoorCrek
417	Door	Door
418	Scratch	Scratch
419	Wind Chime	WindChim
420	Helicopter	Helicptr
421	Car Engine	CarEngin
422	Car Stop	CarStop
423	Car Pass	CarPass
424	Car Crash	CarCrash
425	Siren	Siren
426	Train	Train
427	Jetplane	Jetplane
428	Starship	Starship
429	Burst Noise	BurtNois
430	Applause	Applause
431	Laughing	Laughing
432	Screaming	Scream
433	Punch	Punch
434	Heart Beat	HeartBet
435	Footsteps	Footstep
436	Gunshot	Gunshot
437	Machine Gun	MachnGun
438	Lasergun	Lasergun
439	Explosion	Explosio



# Voice List

Combined Voice		
440	Stereo Piano & Strings Pad	StPn&Str
441	Stereo Piano & Choir	StPn&Cho
442	Stereo Piano & Synth Strings	StPn&Syn
443	Stereo Piano & Warm Pad	StPn&Pad
444	Stereo Piano & Soft Ep	StPn&Ep
445	FM Electric Piano	FMEp
446	Digital Piano	DigiPn
447	E.Piano & Strings	EP&Str
448	E.Piano & Ac Guitar	EP&Gt
449	E.Piano & Vibraphone	Ep&Vib
450	E.Piano 2 & Pad	Ep&Pad
451	E.Piano 2 & Strings	Ep2&Str
452	Harpsichord & Stereo Strings	Harps&St
453	Music Box & Stereo Strings	Mxb&Str
454	Vibraphone & Stereo Strings	Vib&Str
455	Vibraphone Octave	VibOct
456	Vibraphone & Marimba & Kalimba	VibMK
457	Marimba & Kalimba	Mar&Kal
458	Marimba Delay	MarDel
459	Xylophone Octave	XylopOct
460	Organ & Stereo Strings	Org&Str
461	Stereo Organ & Piano	StOr&Pno
462	Rock Organ & Strings	RoOr&Str
463	Church Organ & Choir	ChuOr&Ch
464	Church Organ & Strings	ChuOr&St
465	Acoustic Guitar & Flute	Gt&Fl
466	Acoustic Guitar & Clav	Gt&Cl
467	24 String Guitar	24Gt
468	Steel Guitar & Warm Pad	StGt&Pad
469	Stereo Strings & Horn	StStr&Hn
470	Orchestra	Orchest

471	Full Strings 1	FullStr1
472	Full Strings 2	FullStr2
473	Symphonic	Symphon
474	Stereo Choir & Strings	StCh&Str
475	Stereo Choir & Steel Guitar	Ch&Gt
476	3 Trumpet Loose	3Trump
477	Trombone & Stereo Strings	Tb&StStr
478	3 Trombones Loose	3Tromb
479	3 Muted Trumpets Loose	3MuTrumb
480	Club Brass	ClubBras
481	Brass & Woodwinds	Br&Wood
482	Woodwinds & Strings	Wind&Str
483	Section Woods Small	WoodSma
484	Pan Flute & Strings Pad	PanFu&St
485	Koto & Shamisen	Koto&Sh
Arabic Instruments		
486	Kanoun	Kanoun
487	Aoud	Aoud
488	Bouzouk	Bouzouk
489	Nay	Nay
490	Mizmar	Mizmar
Drum Set		
491	Standard Set	StandSet
492	Room Set	RoomSet
493	Power Set	PowerSet
494	Electronic Set	ElectSet
495	Analog Set	AnalgSet
496	Jazz Set	JazzSet
497	Brush Set	BrushSet
498	Orchestra Set	OrcheSet
499	SFX Set	SFXSet
500	Arabic Set	ArabiSet



# Style List

No.	Full Name	LCD Name
<b>8 BEAT</b>		
1	8Beat Piano	8BtPiano
2	8Beat 1	8Beat1
3	8Beat Shuffle	8BtShuffl
4	Guitar Pop 1	GtPop1
5	8Beat Hip Hop	8BtHiHop
6	8Beat R&B	8BeatR&B
7	8Beat Pop	8BtPop
8	Pop Funk 1	PopFunk1
9	Rhythm & Beat 1	Rhy&Bt1
10	8Beat Disco 1	8BtDisc1
11	8Beat Rock	8BtRock
12	8Beat 2	8Beat2
13	Sweet Beat	SweetBt
14	8Beat Dance	8BtDance
15	8Beat Disco 2	8BtDisc2
16	8Beat 3	8Beat3
17	60's 8Beat	60's8Bt
<b>16 BEAT</b>		
18	16Beat 1	16Beat1
19	16Beat Funk 1	16BtFuk1
20	16Beat Ballad 1	16BtBld1
21	16Beat R&B	16BtR&B
22	Pop 16Beat 1	Pop16Bt1
23	16Beat Funk 2	16BtFuk2
24	16Beat Dance	16BDanc
25	16Beat 2	16Beat2
26	Pop 16Beat 3	Pop16Bt3
27	Modern 16Beat	Modrn16B
28	16Beat Hot	16BtHot
29	16Beat Modern	16BModr
30	16Beat 3	16Beat3
31	Cool Beat	CoolBeat
32	16Beat Ballad 2	16BtBld2
33	16Beat 4	16Beat4
34	Pop Shuffle	PopShuffl
<b>POP</b>		
35	Pop Rock 1	PopRock1
36	Pop Dance 1	PopDanc1
37	Pop Fusion	PopFusn
38	Analog Night 1	AnalgNt1
39	6/8 Pop	6/8Pop
40	Brit. Pop 1	BritPop1
41	Brit. Pop 2	BritPop2
42	Pop Hit	PopHit
43	Fusion Shuffle	FusShuffl
44	Analog Night 2	AnalgNt2
45	Pop Beat	PopBeat
46	Soft Beat	SoftBeat
47	60's Pop	60'sPop
48	Sting Latin	StigLatn
<b>BALLAD</b>		
49	R&B Ballad 1	R&BBad1
50	Guitar Ballad	GtBallad
51	Ballad Rrok	BalladRk
52	Piano Pop	PianoPop

53	Soft Ballad	SoftBald
54	Natural Ballad	NatuBld
55	Love Ballad	LoveBld
56	Easy Ballad	EasyBld
57	Slow Ballad	SlowBald
58	Folk Ballad	FolkBld
59	Pop Ballad 1	PopBld1
60	Pop Ballad 2	PopBld2
61	EP Ballad	EPBallad
<b>ROCK</b>		
62	Rock	Rock
63	New Wave	NewWave
64	Ska	Ska
65	Pop Rock 2	PopRock2
66	Slow Rock	SlowRock
67	70's Rock & Roll	70'sRock
68	Folk Rock	FolkRock
69	Soft Rock	SoftRock
70	Easy Rock	EasyRock
71	New Shuffle	NewShuffl
72	Rock Hip Hop	RkHipHop
73	Rock&Roll 1	R'N'R1
74	Rock & Roll 2	R'N'R2
<b>BALLROOM</b>		
75	Tango 1	Tango1
76	Spain Matador	Matador
77	Twist 1	Twist1
78	Big Band Fox	BandFox
79	Tango 2	Tango2
80	Slow Fox	SlowFox
81	Slow Waltz 1	SlowWlz1
82	Swing Fox	SwingFox
83	Salsa 1	Salsa1
84	Cha Cha 1	ChaCha1
85	Cha Cha 2	ChaCha2
86	Beguine 1	Beguine1
87	Beguine 2	Beguine2
88	Rumba 1	Rumba1
89	Samba 1	Samba1
90	Samba 2	Samba2
91	Jive	Jive
92	Fox Trot	FoxTrot
<b>DANCE</b>		
93	Techno 1	Techno1
94	Hip Hop 1	HipHop1
95	Dream Dance	Drmdance
96	House	House
97	Pop Dance 2	PopDanc2
98	Down Beat	DownBeat
99	Progressive	Progress
100	Rap 1	Rap1
101	Disco	Disco
102	Soft Disco	SoftDisc
103	Disco Party	DscParty
104	70's Disco	70'sDisc
105	Club Dance	ClubDanc
106	Euro Dance	EuroDanc

# Style List

107	Hip Hop 2	HipHop2
<b>SOUL &amp; FUNK</b>		
108	Funk 1	Funk1
109	Classic Funk	ClasFunk
110	Gospel Swing	GopSwing
111	Gospel	Gospel
112	Funk 2	Funk2
113	Electric Funk	ElecFunk
114	Groove Funk	GrooveFk
115	Cool Funky	ColFunky
116	Jazz Funk	JazzFunk
117	Groove	Groove
118	Soul	Soul
119	Hip Hop Beat	HipHopBt
120	R&B	R&B
121	Soul Beat	SoulBeat
122	R&B Ballad 2	R&BBld2
<b>SWING &amp; JAZZ</b>		
123	Latin Jazz 1	LatinJz1
124	Big Band	BigBand
125	Dixieland 1	Dixland1
126	Broadway Big Band	BwayBand
127	Swing	Swing
128	Latin Jazz 2	LatinJz2
129	Fusion	Fusion
130	Acid Jazz	AcidJazz
131	Cool Jazz Ballad	CoolJzBd
132	Swing Shuffle	SwingSfl
133	Big Band Medium	BandMid
134	Dixieland 2	Dixland2
135	Guitar Swing 2	GtSwing2
136	Ragtime	Ragtime
137	Modern Jazz Ballad	MdJzBald
138	Swing Ballad	SwingBal
139	Orchestra Swing	OrhSwing
<b>COUNTRY</b>		
140	Country Pop 1	CntyPop1
141	Bluegrass 1	Bluegrs1
142	Country 8Beat	Ct8Beat
143	Modern Country	ModernCt
144	Country Pop 2	CntyPop2
145	Bluegrass 2	Bluegrs2
146	2/4 Country	2/4Cntry
147	Country Quick Steps	QuickStp
148	Country Folk	CntyFolk
149	Country Shuffle	CnyShufl
<b>LATIN &amp; LATIN DANCE</b>		
150	Bossa Nova	BosaNov
151	Latin	Latin
152	New Reggae	NewRegga
153	Dance Reggae	DanRegga
154	Pasodoble	Pasodobl
155	Lite Bossa	LteBossa
156	Latin Rock	LatinRck
157	Disco Samba	DscSamba
158	Mambo	Mambo
159	Rumba 2	Rumba2

160	Tikitikita	Tikitkta
161	Lambada	Lambada
162	Pop Cha Cha 1	PChaCha1
163	Pop Cha Cha 2	PChaCha2
164	Salsa 2	Salsa2
<b>WALTZ &amp; TRADITIONAL</b>		
165	Waltz	Waltz
166	Old Waltz	OldWaltz
167	English Waltz	EngWaltz
168	German Waltz	GemWaltz
169	ViennaWaltz	VinaWtz
170	Slow Waltz 2	SlwWltz2
171	Jazz Waltz	JzWaltz
172	Polka	Polka
173	6/8 March	6/8March
174	German Polka	GerPolka
175	Party Polka	PtyPolka
176	Army March	ArmMarch
177	March	March
178	US March	USMarch
179	Musette	Musette
180	Mazurke	Mazurke
<b>WORLD</b>		
181	Enka Ballad	EnkaBald
182	Laendler	Laendler
183	Hawaiian	Hawaiian
184	Sirtake	Sirtake
185	Dangdut	Dangdut
186	6/8 Flipper	6/8Flipp
187	New Age	NewAge
188	Tarantella	Tarantel
189	Scottish	Scottish
190	Norteno	Norteno
<b>ARAB</b>		
191	Zarb 6/8	Zarb 6/8
192	Zarb Tempo	ZarbTemp
193	Bandary	Bandary
194	Zarb Daf	Zarb Daf
195	Pop 4/4	Pop 4/4
196	Saidi IR	Saidi IR
197	Cifte	Cifte
198	Baladi	Baladi
199	Masmoudi	Masmoudi
200	Wehda	Wehda

# Song List

No.	Full Name	LCD Name
<b>FOLK &amp; COUNTRY</b>		
1	Jambalaya	Jambalay
2	Ding! Dong! Merrily On High	DingDong
3	Battle Hymne Of The Republic	Battle
4	The Old Gray Mare	GrayMare
5	American Patrol	USPatrol
6	Christmas Is Coming	IsComing
7	Sippin` Cider Through A Straw	SCTStraw
8	Christmas Sound	Sound
<b>GOLDEN &amp; POP</b>		
9	On London Bridge	LdBridge
10	Are You Lonesome Tonight	Lonesome
11	Der Deitcher`s Dog	DerDDog
12	Joy to The World	JoyWorld
13	Silent Night	SltNight
14	Ave Maria	AveMaria
15	Five Hundred Miles	FHMiles
16	Happy New Year	HappyNY
17	It's Beginning To Look A Lot Like Christmas	LikeXmas
18	Jeanie With The Light Brown Hair	LighHair
19	My Bonnie	MyBonnie
20	Song Of The Pearlfisher	SongOTFP
<b>CLASSICAL</b>		
21	Swan	Swan
22	Prelude To Act 2 (Swan Lake)	SwanLak1
23	Valse (Swan lake)	SwanLak2
24	The Happy Farmer	HpFarmer
25	The Sleeping Beauty	SleepBty
26	La Traviata	LaTravia
27	Wiegenlied	Wiegenli
28	Mov.2 Adagio Non Troppo Piano Sonata No.9 In D	Sonata9
29	Mov.1 Andante Grazioso Piano Sonata No.11 In A [Alla TurSonata11ca]	Sonata11

30	Prelude In C	Prelude
31	Chinese Dance	ChDance
32	Emperors Waltz	EmprWalz
33	March Militaire	MilMar1
34	Symphony No.40	Symphony
<b>JAZZ &amp; FUSION</b>		
35	ShanZhaShu	ShanZhaS
36	You Are My Sunshine	MySun
37	June Samba	JunSamba
38	Funk	Funk
39	I Can.....	I Can...
40	Sea Shore	SeaShore
<b>PIANO</b>		
41	Fur Elise	FurElise
42	Military March	MMarch
43	Habanera	Habanera
44	Minuet	Minuet
45	Austria Variation	AVariati
46	Old Macdonald Had A Farm	OldAFarm
47	Wedding March From "Mendelssohn"	Wedding
48	2-Part Invention #13 In A Minor.B.W. Iii	Invtion
49	Minuet In G	MinuetG
50	Turkish March	TurkishM
51	Hey Diddle Diddle	HeDiddle
52	Italian Polka	ItaPolka
53	Moseta Dance	MosetaDn
54	Bulie Dance	BulieDn
55	Waltz For Piano In g-Sharp Minor	Waltz in g
56	Wild Rose	WildRose
57	Away In A Manger	AwayInAM
58	Jack & Jill	JackJill
59	Angles We Have Heard On High	Angles
60	Waltz	Waltz
<b>Demo</b>		
1	Fantasia	Fantasia
2	Funk	Funk
3	Dancing Melody	DanceMld
4	Mystic River	MystRivr
5	Dream of freedom	Dream

# Album List

No.	Full Name	LCD
1	13 Jours en france	Name13JoursEnFR
2	A lover's concerto	ALversConcer
3	A whiter shade of pale	AWHTShade
4	Again	Again
5	Air for the g-string	G-String
6	Always in my heart	AlwInMyheart
7	An der shonen blauen donau	BlauenDonau

8	annie laurie	AnnieLaurie
9	Are you lonesome tonight?	RULoneTonite
10	Arirang	Arirang
11	Around the world	AroundWorld
12	Auf flugeln des gesanges	Gesanges
13	Auld lang syne	AuldLangSyne
14	Ave maria	Ave maria
15	Beautiful dreamer	BeauDreamer

# Album List

16	Beyond the reef	BeyondThReef
17	Blue tango	BlueTango
18	Brazil	Brazil
19	Bridal march	BridalMarch
20	Can't help fallin' in love	CantHlpFalLv
21	Carry me back to old virginny	CarryMeBack
22	Chanson du toreador	Toreador
23	Dance des mirlitons	Mirlitons
24	Danny boy	DannyBoy
25	Do re mi	DoReMi
26	Ebb tide	Ebb Tide
27	El condor pasa	ElCondorPasa
28	Etude op.10 no.3	Etude3
29	Five hundred miles	500 miles
30	Fly me to the moon	FlyMeMoon
31	Frohlicher landmann	landmann
32	Fruhlingsstimmen	FLingsTimmen
33	Gavotte	Gavotte
34	Green, green grass of home	Green Grass
35	Greensleeves	Greensleeves
36	Happy birthday to you	Birthday
37	Hey jude	HeyJude
38	Home sweet home	SweetHome
39	How deep is your love	HDeepIsUrLv
40	Hungarian dances no.5	HUdances5
41	Hymne a l'amour	Hymnel'amour
42	If	If
43	In the mood	InTheMood
44	Jingle bells	Jingle bells
45	Joy to the world	JoyTheWorld
46	Kaiser walzer	KaiserWalzer
47	La mer	LaMer
48	La paloma	LaPaloma
49	La playa	La playa
50	La reine de saba	Saba
51	L'amour est blue	L'amourBlue
52	Lara's theme from "Doctor zhivago"	DoctorZhivag
53	Last waltz	LastWaltz
54	Long,long ago	LonglongAgo
55	Love Story	LoveStory
56	Mambo No.5	Mambo No.5
57	Mambo No.8	Mambo8
58	Massachusetts	Massachusett
59	Menuet	Menuet
60	Miami beach rumba	MIABechRumba
61	Military march	MilMarch
62	Misty	Misty
63	Moon river	Moon River
64	My darling clementine	MDarinClemnt
65	My way	MyWay
66	Never on sunday	NeverOnSun.
67	New world	NewWorld
68	O sole mio	OSoleMio
69	Oh! Carol	OhCarol
70	Oh! Susanna	OhSusanna

71	Old folks at home	Old folks
72	One way ticket to the blues	OnWyTicktBlis
73	Only you	OnlyYou
74	Over the rainbow	OverRainbow
75	Petite fleur	PetiteFleur
76	Red river valley	RedRiver
77	Rhythm of the rain	RhythmOfRain
78	Rock around the clock	RockArndClk
79	Sail along silv'ry moon	SalAlongMoon
80	Sailing	Sailing
81	Santa lucia	Santa lucia
82	Sealed with a kiss	SealedW/Kiss
83	Serenade	Serenade
84	Serenata rimpiant	Serenata
85	Siboney	Siboney
86	Silent night	Silent night
87	Sleepy lagoon	SleepyLagoon
88	Songs of Spring	SongSpring
89	Speak softly love	SpeakSoftLv
90	Summertime	Summertime
91	Superstar	Superstar
92	Swan lake	SwanLake
93	Sweet and gentle	Sweet&Gentle
94	Tennessee waltz	TN Waltz
95	The end of the world	EndOfThWorld
96	The girl from ipanema	GirlFromIpan
97	The house of the rising sun	HousOfRisSun
98	The river of no return	RiverOfNoRet
99	The shadow of your smile	Your smile
100	The siaters waltzes	SiatersWaltz
101	The sound of silence	SndOfSilence
102	The way we were	TheWayWeWere
103	Tico-tico	Tico
104	Tie a yellow ribbon'round the ole oak tree	YellowRibbon
105	Toccata	Toccata
106	Tombe la neige	TombeLaNeige
107	Top of the world	TopOfThWorld
108	Traumerei	Traumerei
109	Triumphal march	Triumphal
110	Una lacrima sul viso	ULSViso
111	Unchained melody	UnchainMelod
112	Valse des fleurs	ValseFleurs
113	Waves of the danube	WavesDanube
114	Wedding march	WeddingMarch
115	Wiegenlied	Wiegenlied
116	Wiegenlied	Wiegenlied
117	Words	Words
118	Yesterday	Yesterday
119	Yesterday once more	OnceMore
120	You are my sunshine	UrMySunshine

# Chord List

Chord Name (Abbreviation)	Normal Voicing	Chord	Display
Major [M]	1-3-5	C	C
Major sixth [6]	1-(3)-5-6	C6	C6
Major seventh [M7]	1-3-(5)-7	CM7	CM7
Major seventh sharp eleventh [M7#11]	1-(2)-3-#4-(5)-7	CM7#11	CM7#11
Major add ninth [Madd9]	1-2-3-5	Cmadd9	CM(9)
Major ninth [M9]	1-2-3-(5)-7	CM9	CM7(9)
Major sixth add ninth [6 9]	1-2-3-(5)-6	C6 9	C6(9)
Augmented [aug]	1-3-#5	Caug	Caug
Minor [m]	1-b3-5	Cm	Cm
Minor sixth [m6]	1-b3-5-6	Cm6	Cm6
Minor seventh [m7]	1-b3-(5)-b7	Cm7	Cm7
Minor seventh flatted fifth [m7b5]	1-b3-b5-b7	Cm7b5	Cm7b5
Minor add ninth [madd9]	1-2-b3-5	Cmadd9	Cm(9)
Minor ninth [m9]	1-2-b3-(5)-b7	Cm9	Cm7(9)
Minor eleventh [m11]	1-(2)-b3-4-5-(b7)	Cm11	Cm7(11)
Minor major ninth [mM7]	1-b3-(5)-7	CmM7	CmM7
Minor major ninth [mM9]	1-2-b3-(5)-7	CmM9	CmM7(9)
Diminished [dim]	1-b3-b5	Cdim	Cdim
Diminished seventh [dim7]	1-b3-b5-6	Cdim7	Cdim7
Seventh [7]	1-3-(5)-b7	C7	C7
Seventh suspended fourth [7sus4]	1-4-5-b7	C7sus4	C7sus4
Seventh flatted fifth [7b5]	1-3-b5-b7	C7b5	C7b5
Seventh ninth [7 9]	1-2-3-(5)-b7	C7 9	C7(9)
Seventh sharp eleventh [7#11]	1-2-3-#4-(5)-b7 or 1-(2)-3-#4-5-b7	C7#11	C7(#11)
Seventh thirteenth [7 13]	1- 3-(5)-6-b7 or 2- 3-5-6-b7	C7 13	C7(13)
Seventh flatted ninth [7b9]	1-b2-3-(5)-b7	C7b9	C7(b9)
Seventh flatted thirteenth [7b13]	1-3-5-b6-b7	C7b13	C7(b13)
Seventh sharp ninth [7#9]	(1)-#2-3-(5)-b7	C7#9	C7(#9)
Major seventh augmented [M7aug]	1-3-#5-7	CM7aug	CM7aug
Seventh augmented [7aug]	(1)-3-#5-b7	C7aug	C7aug
Suspended fourth [sus4]	1-4-5	Csus4	Csus4
One plus two plus five [1+2+5]	1-2-5	C1+2+5	C

# MIDI Implementation Chart

Function		Transmitted	Recognized	Remarks
Basic Channel	Default	1ch	1-16ch	
	Changed	1-16ch	1-16ch	
Mode	Default	x	3	
	Messages	x	x	
	Altered	*****	x	
Note Number	Note	0—127	0—127	
	:True voice	*****	0—127	
Velocity	Note on	o 9nH,V=1-127	o 9nH,V=1-127	
	Note off	x (9nH,V=0)	o(9nH,V=0; 8nH,V=0-127)	
After Touch	key's	x	x	
	Ch's	x	x	
Pitch Bend		x	o	
Control Change	0	o	o	Bank Select
	1	x	o	Modulation
	5	x	o	Portamento Time
	6	o	o	Data Entry
	7	o	o	Volume
	10	x	o	Pan
	11	x	o	Expression
	64	o	o	Sustain Pedal
	65	x	o	Portamento ON/OFF
	66	o	o	Sostenuto Pedal
	67	o	o	Soft Pedal
	80	x	o	Reverb Program
	81	x	o	Chorus Program
	91	o	o	Reverb Level
	93	o	o	Chorus Level
	120	o	o	All Sound Off
	121	x	x	Reset All Controllers
123	o	o	All Notes Off	
Program Change	:true	*****	0—127	
System Exclusive		x	o	
System Common	:SongPosition	x	x	
	:Song Select	x	x	
	:Tune	x	x	
System Real Time	:Clock	o	x	
	:Commands	x *1	x	
Aux Messages	:LOCAL ON/OFF	x	x	
	:Active sense	x	o	
	:Reset	x	x	
Notes: *1 When the accompaniment is started, an FAH message is transmitted. When accompaniment is stopped, an FCH message is transmitted.				

- Mode 1: OMNI ON, POLY
- Mode 2: OMNI ON, MONO

- Mode 3: OMNI OFF, POLY
- Mode 4: OMNI OFF, MONO

- x: NO
- o: YES

A tuning system is the system used to define which tones, or pitches, to use when playing music. In other words, it is the choice of number and spacing of frequency values used. The equal temperament (has only one tuning method, and is suitable for keyboard) is the common musical scale used at present, used for the tuning of pianos and other instruments of relatively fixed scale. One of the advantages of the equal tempered scale is that it is the same in any musical "key", so that compositions may be freely transposed up or down without changing the musical intervals. Especially for piano, equal temperament is widely used and taken for granted. But people used several other scales to compose and perform before adopting the equal temperament. This piano has been equipped with 6 scale tuning systems, you can select one to reappearing its matched chord of the melody at that time.

## Characteristics of Different Scale Tuning Systems

### Pythagorean

The Pythagorean tuning, named after the ancient mathematician and philosopher Pythagoras, is based on a stack of intervals called perfect fifths. It is particularly well suited to music which treats fifths as consonances, and thirds as dissonances.

### Pure Major & Pure Minor

In music, just intonation (sometimes abbreviated as JI) or pure intonation is any musical tuning in which the frequencies of notes are related by ratios of small whole numbers. Any interval tuned in this way is called a pure or just interval. And the major scale which consisted of just intonations especially for this triad chords: Root, Third, Fifth are sounded extremely harmony. The just intonation must be the most natural temperament.

### Meantone

The Meantone System is a musical temperament which is close to just intonation. Used to tuning pipe organ in 16th century Europe. These musical scales which based on the Pythagorean System, minus quarter of common comma for once, are extremely approaching just intonation. So, use this system to create musical scales are sound beautiful and pure, just like a perfect triad chord.

### Werckmeister

The Werkmeister was named after Andreas Werckmeister, and this scale was created as an improvement on the Pythagorean scale. This tuning collapse comma maxima, created by Pythagorean, into four perfect fifths, the rest fifths still remain their Pythagorean scale characteristics. Werkmeister Tuning can tune scale from harmonic to melodic by increasing tone number, making each tonality sound distinct, this is the important gist for classicists and romanticism tonality music to name the tone name.

### Kirnberger

Kirnberger temperament is an irregular temperament developed in the second half of the 18th century by Johann Kirnberger and regarded as an improved version of Meantone temperament. It makes possible to switch different tunes freely when performing.

### Twelve-tone equal temperament

In twelve-tone equal temperament, which divides the octave into 12 equal parts, the width of a semitone, i.e. the frequency ratio of the interval between two adjacent notes, is the twelfth root of two. There is minute difference of the same amount between each two intervals.

