



Hear. Feel. Connect.

voidacoustics.com



Bias

D1+

Q1+

Q1.5+

Q2+

Powering the future of sound

USER GUIDE V4.0

©2024 Void Acoustics Research Ltd.







This user guide is subject to change without notice.
For the latest online version, visit: www.voidacoustics.com

Void Acoustics and the Void logo are registered trademarks of Void Acoustics Research Ltd. in the United Kingdom, USA and other countries; all other Void trademarks are the property of Void Acoustics Research Ltd.

Important Safety Instructions



Common symbols and meanings

-  THE TRIANGLE WITH THE LIGHTNING BOLT IS USED TO ALERT THE USER TO THE RISK OF ELECTRIC SHOCK.
-  THE TRIANGLE WITH THE EXCLAMATION POINT IS USED TO ALERT THE USER TO IMPORTANT OPERATING OR MAINTENANCE INSTRUCTIONS.
-  THE CE-MARK INDICATES THE COMPLIANCE OF THE PRODUCT TO ALL THE APPLICABLE EUROPEAN DIRECTIVES
-  SYMBOL FOR EARTH/GROUND CONNECTION.
-  SYMBOL INDICATING THAT THE EQUIPMENT IS FOR INDOOR USE ONLY.
-  SYMBOL FOR CONFORMITY WITH DIRECTIVE 2012/19/EC OF THE EUROPEAN PARLIAMENT ON WASTE ELECTRICAL AND ELECTRONIC EQUIPMENT (WEEE).

Safety Warnings

-  OPERATING TEMPERATURE RANGE: 0°C TO +35°C - DERATING ABOVE 35°C.
-  STORAGE RELATIVE HUMIDITY RANGE: 10% TO 85% HUMIDITY (NON CONDENSING).
-  DO NOT USE THE UNIT AT ALTITUDES ABOVE 2000 M.
-  DO NOT USE THE UNIT IN TROPICAL ENVIRONMENT.
-  TO REDUCE THE RISK OF ELECTRIC SHOCK, DO NOT ATTEMPT TO OPEN ANY PART OF THE UNIT. NO USER-SERVICEABLE PARTS INSIDE. REFER SERVICING TO QUALIFIED SERVICE PERSONNEL.
-  CONNECTION TO THE MAINS SHALL BE DONE ONLY BY A ELECTROTECHNICAL SKILLED PERSON ACCORDING THE NATIONAL REQUIREMENTS OF THE COUNTRIES WHERE THE UNIT IS SOLD.
-  DO NOT USE THIS AMPLIFIER IF THE ELECTRICAL POWER CORD IS FRAYED OR BROKEN.
-  TO AVOID ELECTRICAL SHOCK, DO NOT TOUCH ANY EXPOSED SPEAKER WIRING WHILE THE AMPLIFIER IS OPERATING.
-  DO NOT SPILL WATER OR OTHER LIQUIDS INTO OR ON THE AMPLIFIER.
-  THIS DEVICE MUST BE POWERED EXCLUSIVELY BY EARTH CONNECTED MAINS SOCKETS IN ELECTRICAL NETWORKS COMPLIANT TO THE IEC 364 OR SIMILAR RULES
-  DISCONNECT THE AC MAINS SOURCE BEFORE ATTEMPTING TO CLEAN ANY PART OF THE AMPLIFIER
-  VOID SUGGESTS TO PLUG THE BIAS D1+/Q1+/Q2+ SERIES TO A 16 A RATING, C OR D CURVE, 10 kA SECTIONING BREAKER.
-  OUTPUT TERMINALS ARE HAZARDOUS. WIRING CONNECTION TO THESE TERMINALS REQUIRES INSTALLATION BY AN INSTRUCTED PERSON AND THE USE OF READY MADE LEADS.
-  **CLASS 3 WIRING**
-  PROPERLY FIT THE AC MAINS PLUG TO THE AMPLIFIER INLET. BEFORE POWERING THIS AMPLIFIER, VERIFY THAT THE CORRECT VOLTAGE RATING IS BEING USED.
-  TAKE CARE TO LOCK THE OUTPUT TERMINAL BEFORE SWITCHING THE DEVICE ON.
-  VERIFY THAT YOUR MAINS CONNECTION IS CAPABLE OF SATISFYING THE POWER RATINGS OF THE DEVICE.
-  NO NAKED FLAME SOURCES SUCH AS LIGHTED CANDLES SHOULD BE PLACED ON THE AMPLIFIER.
-  IT IS HIGHLY RECOMMENDED TO UNPLUG THE OUTPUT CONNECTORS BEFORE PROCEEDING WITH THE SELF CHECK PROCEDURE
-  THE TESTING SIGNALS MIGHT CAUSE LOUDSPEAKER IMPAIRMENTS.
-  TO PREVENT INJURY, THIS APPARATUS MUST BE SECURELY RACK MOUNTED IN ACCORDANCE WITH THE INSTALLATION INSTRUCTIONS.
-  THIS EQUIPMENT SHALL BE MOUNTED AT A MAXIMUM HEIGHT OF 2 M
-  THE MANUFACTURER CANNOT BE HELD RESPONSIBLE FOR DAMAGES CAUSED TO PERSONS, THINGS OR DATA DUE TO AN IMPROPER OR MISSING GROUND CONNECTION.
-  IT IS ABSOLUTELY NECESSARY TO VERIFY THESE FUNDAMENTAL REQUIREMENTS OF SAFETY AND, IN CASE OF DOUBT, REQUIRE AN ACCURATE CHECK BY QUALIFIED PERSONNEL.

Please read and keep all safety and use instructions.

This product is intended for installation by professional installers only! This document is intended to provide professional installers with basic installation and safety guidelines for this product in typical fixed-installation systems. Please read this document and all safety warnings before attempting installation.

1. Read these instructions.
2. Keep these instructions.
3. Heed all warnings.
4. Follow all instructions.
5. Do not use this equipment near water.
6. Clean only with a dry cloth.
7. Do not block any ventilation openings. Install in accordance with the manufacturer's instructions.
8. Do not install near any heat sources such as radiators, heat registers, stoves, or other apparatus that produce heat.
9. Do not defeat the safety purpose of the polarized or grounding-type plug. A polarized plug has two blades with one wider than the other. A grounding-type plug has two blades and a third grounding prong. The wide blade or the third prong are provided for your safety. If the provided plug does not fit into your outlet, consult an electrician for replacement of the obsolete outlet.
10. Protect the power cord from being walked on or pinched particularly at plugs, convenience receptacles, and the point where they exit from the apparatus.
11. Only use attachments/accessories specified by the manufacturer.
12. Use only with the cart, stand, tripod, bracket, or table specified by the manufacturer, or sold with the apparatus. When a cart is used, use caution when moving the cart/apparatus combination to avoid injury from tip-over. 
13. Unplug this apparatus during lightning storms or when unused for long periods of time.
14. Refer all servicing to qualified service personnel. Servicing is required when the apparatus has been damaged in any way, such as power-supply cord or plug is damaged, liquid has been spilled or objects have fallen into the apparatus, the apparatus has been exposed to rain or moisture, does not operate normally, or has been dropped.

Regulatory Compliance Statements

Europe

If the time arises to dispose of your product, please recycle all possible component.



This symbol indicates that when the end-user wishes to discard this product, it must be sent to separate collection facilities for recovery and recycling. By separating this product from other household-type waste, the volume of waste sent to incinerators or land-fills will be reduced and natural resources will thus be conserved.

The Waste Electrical and Electronic Equipment Directive (WEEE Directive) aims to minimise the impact of electrical and electronic goods on the environment. Void Acoustics Research Ltd comply with the Directive 2012/19/EU of the European Parliament on waste electrical and electronic equipment (WEEE) in order to reduce the amount of WEEE that is being disposed of in land-fill site. All of our products are marked with the WEEE symbol; this indicates that this product must NOT be disposed of with other waste. Instead it is the user's responsibility to dispose of their waste electrical and electronic equipment by handing it over to an approved reprocessor, or by returning it to Void Acoustics Research Ltd for reprocessing. For more information about where you can send your waste equipment for recycling, please contact Void Acoustics Research Ltd or one of your local distributors.

USA

FCC Supplier's Declaration of Conformity

Responsible Party:

Void Acoustics Research Ltd
Unit 15, Dawkins Road Industrial Estate
Poole, BH15 4JY, United Kingdom
Phone: +44 (0) 1202 666006
Email: sales@voidacoustics.com

FCC Compliance Statement

This device complies with part 15 of the FCC rules. Operation is subject to the following two conditions:

- 1) This device may not cause harmful interference, and
- 2) this device must accept any interference received, including interference that may cause undesired operation.

CAUTION: Changes or modifications not expressly approved by the party responsible for compliance could void the user's authority to operate the equipment.

NOTE: This equipment has been tested and found to comply with the limits for a Class A digital device, pursuant to part 15 of the FCC Rules. This equipment generates, uses, and can radiate radio frequency energy and, if not installed and used in accordance with the instruction manual, may cause harmful interference to radio communications. However, there is no guarantee that interference will not occur in a particular installation. If this equipment does cause harmful interference to radio or television reception, which can be determined by turning the equipment off and on, the user is encouraged to try to correct the interference by one or more of the following measures:

- Reorient or relocate the receiving antenna.
- Increase the separation between the equipment and receiver.
- Connect the equipment into an outlet on a circuit
- Different from that to which the receiver is connected.

WARNING: This is a class A product. In a domestic environment this product may cause radio interference in which case the user may be required to take adequate measures

Canada

Canadian Caution

This device contains licence-exempt transmitter(s)/receiver(s) that comply with Innovation, Science and Economic Development Canada's licence-exempt RSS(s).

Operation is subject to the following two conditions:

- 1) This device may not cause interference.
- 2) This device must accept any interference, including interference that may cause undesired operation of the device.

WARNING: This is a class A product. In a domestic environment this product may cause radio interference in which case the user may be required to take adequate measures

ICES-003 Class A Notice

This Class A digital apparatus complies with Canadian ICES-003.

Radiation Exposure Statement

This equipment complies with RSS-102 radiation exposure limits set forth for an uncontrolled environment. This equipment should be installed and operated with minimum distance 20cm between the radiator & your body.

EC declaration of conformity

For EC Declaration of Conformity please go to:

www.voidacoustics.com/eu-declaration-amplifiers

UKCA marking

For details of the UKCA marking go to:

www.voidacoustics.com/uk-declaration-amplifiers

Warranty statement

For warranty statement go to:

<https://voidacoustics.com/terms-conditions/>

Preliminary operations

Package list

The box contains the following:

1x Bias D1+ amplifier.
1x Phoenix MC 1,5/4-ST-3,81 - 1803594 plug
2x Phoenix MC 1,5/6-ST-3,81 - 5447900 plug
1x Phoenix PC 5/4-STF1-7,62 - 177859 plug
1x IEC power cord
1x User guide

OR

1x Bias Q1+/Q1.5+/Q2+ amplifier.
1x Phoenix MC 1,5/4-ST-3,81 - 1803594 plug
2x Phoenix MC 1,5/12-ST-3,81 - 1803675 plug
1x Phoenix PC 5/8-STF1-7,62 - 177891 plug
1x IEC power cord
1x User guide

Location

Install your Bias+ Series Amplifier in well ventilated rack cabinets.
Secure both front and rear brackets to the rack.
Connect the AC Mains connector to a circuit breaker.
Install the amplifier far from EMF emitting devices.
Avoid placing the amplifier close to heat generating sources.

Cooling

The ventilation openings must not be impeded by any item, keep a distance of at least 50 cm from the front and rear ventilation openings of the amplifier.
Bias+ Series implements a forced-air cooling system to maintain constant operating temperatures. Air enters from the front panel, exiting at the back of the amplifier.
The cooling system features variable-speed DC fans controlled by the heat sink mounted sensors. This ensures that fan noise and internal dust accumulation are kept to a minimum.
In the rare event of overheating, sensing circuits shut down all channels until the amplifier cools down to a safe operating temperature. Normal operation is resumed automatically without the need for user intervention.
Bias+ Series amplifiers can be stacked one on top of the other, leave one rack unit empty every four to guarantee adequate air flow.

Cleaning

Use a dry cloth for cleaning the chassis and the front panel. Air filter cleaning should be scheduled in accordance with the dust levels in the amplifier's operating environment.
In order to clean the vent filters remove the front cover by firmly gripping the outermost silver panels and pull them outwards
Use compressed air to remove the dust from filters, or wash it with clean water (let the filter dry thoroughly before reinstalling them).

AC Mains Supply

Bias+ Series amplifiers implement an universal switching mode power supply with power factor correction operating in the range from 100 V_{AC} up to 240 V_{AC} ±10%.
AC mains connection is in the rear panel through the IEC C20 inlet, the approved power cord is provided.

Switching the amplifier On and Off

Once properly powered (power cord inserted, sectioning breaker closed), the system can be either ON or in STANDBY mode depending on its state at latest power off.
In order to toggle the amplifier between ON and STANDBY keep pressed the power button for 3 seconds. Please consider that the operating condition can be modified by the REMOTE ON and REMOTE OFF configuration.

Energy Save

The Smart Rails Management technology implemented in the power supply unit allows to reduce the power consumption when the input signal falls under a defined threshold.
When On, Energy Save is active on each channel independently. If the signal is missing for more than 30 minutes on all channels, the auto standby is applied and the main PSU is turned off to further save energy (Time out time is selectable via Armonia in AoIP Enabled Versions).
Normal operation is resumed in a matter of milliseconds when an incoming signal is detected.
In order to activate the Energy Save feature, operate the NRG SAVE dip switch on the rear panel.

Breaker Save

This feature may be activated when the power grid is unable to provide enough current to continuously drive the loads, or when the number of amplifier connected to the same outlet is such that one can reach the critical power absorption of the line.
When activated, the Breaker Save halves the maximum continuous current absorption from the mains. This slightly reflects on the overall performance of the system, reducing the available output power.
In order to activate the Breaker Save feature, locate the BRK SAVE switch on the rear panel.

Remote On/Off

Remote ON/OFF is available through the dedicated terminals on the rear panel.
Both terminals respond to the differential voltage between the contacts: a voltage difference in the range 5V_{DC} - 24V_{DC} triggers the control. Any voltage exceeding 28 V_{DC} may damage the input circuitry.
The couple of terminals act depending on the actual state of the amplifier, in accordance with the following table.

REMOTE ON	REMOTE OFF	AMPLIFIER STATE
Vdiff ≥ 5V	Any	Force Turn ON
Vdiff < 3V	Vdiff ≥ 5V	Force Turn OFF
Vdiff < 3V	Vdiff < 3V	No Change (Keep either standby or in current state)

Gain selection

The Bias+ Series amplifiers can operate with different gain applied to the input signal. This feature is designed to match the voltage of the input signal.
A proper combination of the position of two GAIN switches on the rear panel sets the operating gain of the amplifier.

Connections

Signal Grounding

There is no ground switch or terminal on the Bias+ Series amplifiers. The unit's signal grounding system is automatic.
In order to limit hum and/or interference entering the signal path, use balanced input connections.
In the interests of safety, the unit MUST always operate with electrical safety earth connected to the chassis via the dedicated Protective Earth Ⓢ wire.

Analog Audio Input connections

Analog input connections are made via the Phoenix MC 1,5/6-ST-3,81 5447900 connector.

Remote Level adjustment

The level of each channel can be remotely adjusted by means of a linear 10 kΩ potentiometer connected to the input LEVEL connector.
When the CH1 MSTR switch is in the OFF position the remote level potentiometers work independently on each separate channel.
When the CH1 MSTR switch is in the ON position the remote level potentiometer of channel 1 acts as a master level, controlling the volume of both channels.
The remote level controls are in series with the level adjustment knobs in the front panel.

Digital Audio Input connection

AoIP enabled models accept two input streams from the dedicated audio over the IP port. Cabling must comply to TIA/EIA-568-B and adopt the T568B scheme pinout. In order to implement a Dante™ network, a computer running Dante™ Controller should be used. Dante™ Controller is a software application that manages devices on the network. AoIP enabled Bias+ Series amplifiers are automatically discovered and displayed in Dante™ Controller with the default identifier:

MODELNAME-SERIAL (e.g. BiasD1+-71520).

Ethernet connection

The port labelled Ethernet is designed to remotely control the amplifier via an Ethernet connection through a personal computer and ArmoniaPlus software.

Void recommend the use of Ethernet Cat5 straight through – patch – cables with pin/pair assignments TIA/EIA-568-B, i.e. T568B.

Output connections

Output connections are made via the Phoenix PC 5/4-STF1-7,62 177859 port.

Any mixed configuration of low and high impedance output loads can be made: in order to set the load configuration, each channel is provided with four DIP switches.

Hi-Z 70V/100V operations

Any channel can drive 70V/100V (Hi-Z) distributed line loudspeakers. In order to connect any channel's output to a 70V/100V line, the rear panel DIP switch corresponding to the channel must be set.

Void recommends to use the built-in HPF (High Pass Filter) when the amplifier is set to drive a distributed line to prevent loudspeaker transformer saturation, which can considerably degrade sound performance. The HPF can be activated by means of the DIP switch corresponding to the channel, two cutting frequencies are available 35 Hz and 70 Hz.

Lo-Z 2Ω load operation

Bias+ Series amplifiers are optimized for working with 4Ω output loads but a special configuration allows to connect low loads down to 2Ω.

The 2Ω switch allows to activate on all output channels set to match low impedance (i.e. in Lo-Z configuration) an operating condition that optimizes the performance with very low loads, by limiting the maximum output voltage to 85 V_{peak} per channel.

For optimal 2Ω performance, it is recommended to select LowZ mode for all the amplifier's channels.

Note that 2Ω capabilities are not supported by Q2+ models, the dip switch is therefore marked "USR C", and its function is reserved.

Diagnostics - GPO - Alarms

Bias+ Series provides a pair of paralleled general purpose output connections per channel: one Normally Open ⊕ NO and one Normally Closed ⊕ NC.

The connections are available on the back panel via the 6-pin Phoenix MC 1.5/6-ST-3.81 5447900 connector.

When the amplifier is in normal operating condition the NO contacts are closed, whilst the NC contacts are open, and vice-versa.

These contacts are used to report potentially dangerous faults or generally unsafe operation conditions by toggling alarm switches relative to the following events, and any fault preventing the normal operation of an output channel:

No AC mains (i.e. system shutdown);

Thermal stress: the system temperature is too high and the thermal protection is engaged;

Short circuit in output wiring: either the loudspeaker or the line is in short; Amplifier is in Standby

AoIP versions feature further monitoring on pilot tone and output load through ArmoniaPlus.

Self Check

The self check procedure tests the amplifier status and reports the user in case of failures.

After few minutes, at the end of the self check procedure, a combination of lit LED in the LED panel provides information about the amplifier status.

In order to exit the self check test and resume normal operations, press once the self check push button ⑥.

If self check cannot be started because of a fault, the check LED will blink fast, whilst a reassuring slow blink is an indication of a completed self check procedure.

Pilot Tone monitoring

The detection of a mismatch in the input pilot tone parameters (frequency and voltage level) can be used to trigger the backup policy and activate an alert through the general purpose output switch.

The output pilot tone detection relies on an external signal passing through the amplifier or the internal post DSP pilot tone generator; in both cases any mismatch between the detected signal and the set thresholds triggers the general purpose output switches.

Networking

Bias+ Series amplifiers support star network topology via the Ethernet port and AES67 dedicated AoIP port (where available).

IP Addressing

Factory default network settings are DHCP/AutoIP.

In order for the amplifier to self-configure when connected to an existing LAN or PC. Fixed IP policy can also be adopted and configured through ArmoniaPlus.

If a DHCP server is not active within the network, the amplifier platform initiates a stateless address auto-configuration (i.e. Zero-configuration networking methodology – Zeroconf): it self assigns a local numeric network address (of the type 169.254.x.y – 172.31.*.* for the secondary network if present – with a subnet mask 255.255.0.0) and automatically distributes and resolves the host names of the networking devices.

Both Armonia and the Bias+ Series amplifier must belong to the same subnet. If a DHCP server is present on the network and a Bias+ Series amplifier is in AUTO IP, networking may become unstable.

As a rule of thumb, turn the DHCP server on before connecting the amplifiers.

IP addressing of a Bias+ Series amplifier is established during the bootstrap: when the amplifier discovers a DHCP server on the network during the startup, it negotiates the networking parameters. If the Bias+ Series amplifier does not reveal a DHCP server on the network during the startup, it set itself in AUTO IP mode.

ArmoniaPlus

ArmoniaPlus is the default configuring interface that allows system setting and customization of the Bias+ Series amplifiers. Armonia can be installed on a PC running Windows (XP SP3 and higher).

Download ArmoniaPlus for free from the dedicated website:

<https://www.powersoft.com/en/software/armoniaplus/>

Input selection and Backup Policy

In Bias+ Series amplifiers it is possible to select among two input signal sources per channel: analog and AES67 streams. ArmoniaPlus software provides an interface to select the input source.

Furthermore Bias+ Series amplifiers implement a backup policy aimed to improve reliability against signal fault. By assigning a bus priority to the two different input sources per channel, the system is able to automatically switch to a reliable input connection in case of signal drop or pilot tone mismatch.

Output Load monitoring

Through the ArmoniaPlus software it is possible to set the thresholds on the load impedance, at given frequency, that trigger the general purpose output of any channel in Bias+ Series amplifiers.

Location

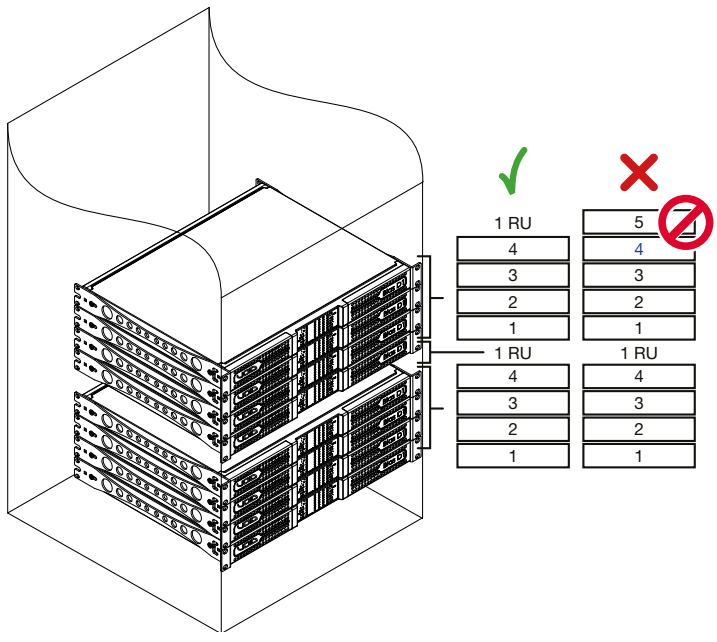

Cooling

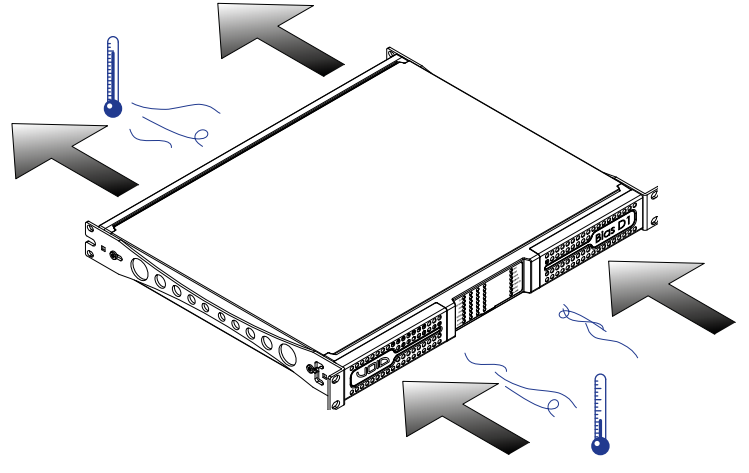

Exposing the Control Panel

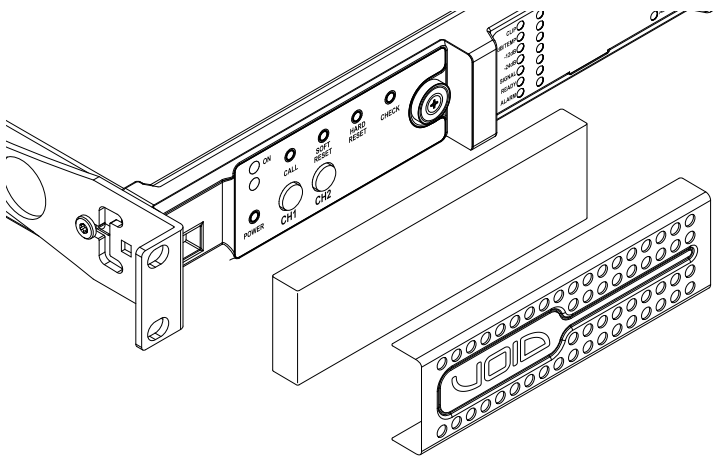

Dimensions

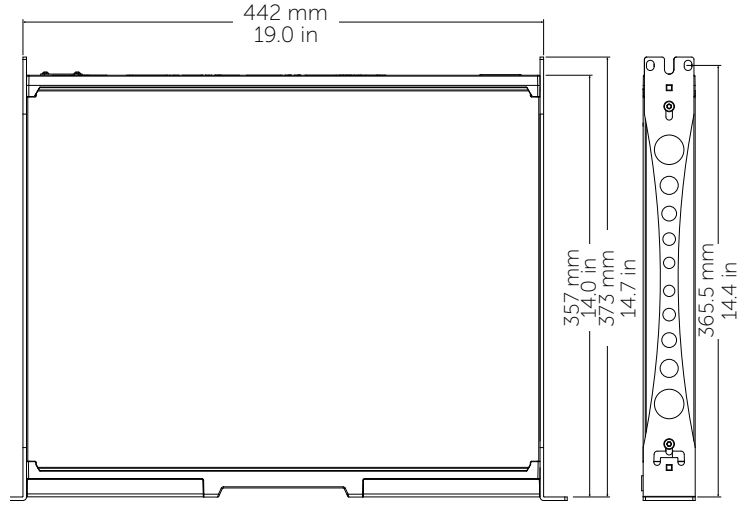

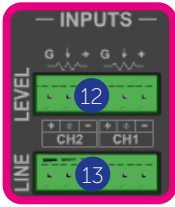

Input section

- 12 Remote Level connector
- 13 Line Input connector

Bias D1+

Input

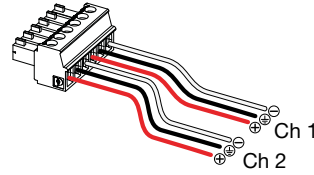

Remote Level

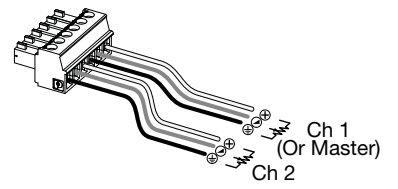

Bias Q1+/Q1.5+/Q2+

Input

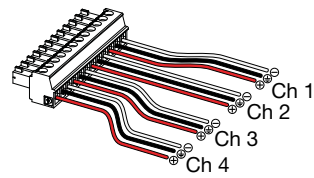

Remote Level

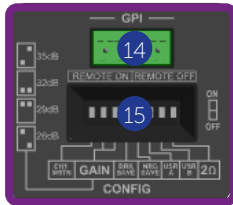
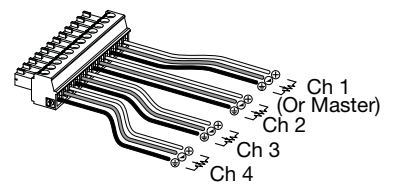

Remote On/Off - Configuration dip switches

- 14 Remote On/Off connector (Phoenix MC 1,5/4-ST-3,81 1803594)
- 15 System Configuration dip switches

Remote On/Off

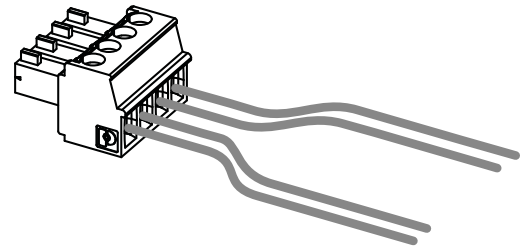

Input Gain Selection

26 dB	29 dB	32 dB	35 dB	CH1 Master	BRK Save	NRG Save	USR A	USR B	2 Ω*
2-3	2-3	2-3	2-3	1	4	5	6	7	8

* Bias Q1+/Q1.5+ models only. Bias Q2+: USR C (reserved)

Bias D1+

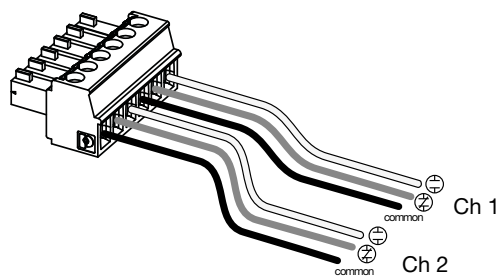

Bias Q1+/Q1.5+/Q2+

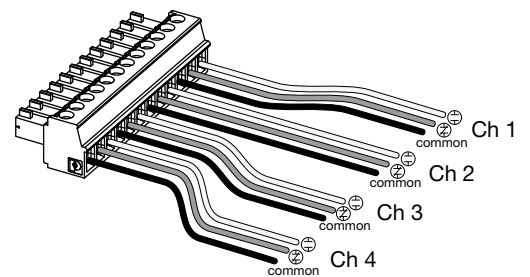

Alarm
GPO/Alarm connector



Ethernet and AoIP ports

- 16 Ethernet port (RJ45)
- 17 AES67 port (RJ45) - Bias+ Series only

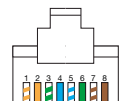
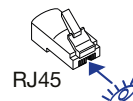

Color code (TIA/EIA-568-B)	Pin
	1
	2
	3
	4
	5
	6
	7
	8

Front Panel

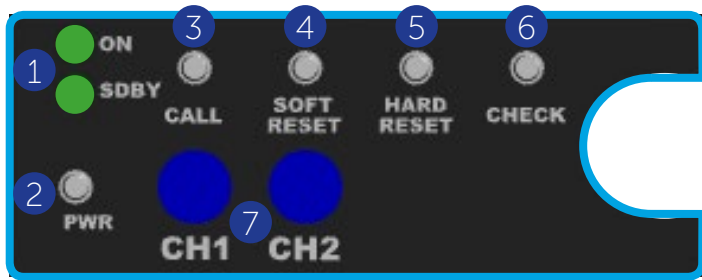

Control Panel

- 1 Operating Mode LEDs (ON/STANDBY)
- 2 Power pushbutton
- 3 Armonia Callback pushbutton
- 4 Soft Reset pushbutton
- 5 Hard Reset pushbutton
- 6 Self Check pushbutton
- 7 CH1, CH2 attenuators (+ CH3, CH4 - Bias Q1+/Q1.5+/Q2+)

LED Panel

- 8 Channel Status LED meters
- 9 System Status LEDs

Serial Port

Reserved for service operations.

Rear Panel

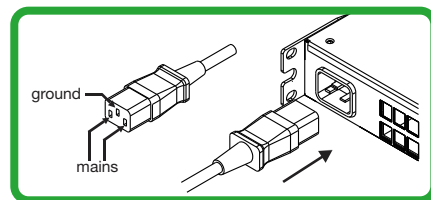
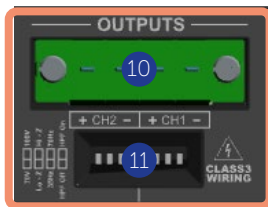
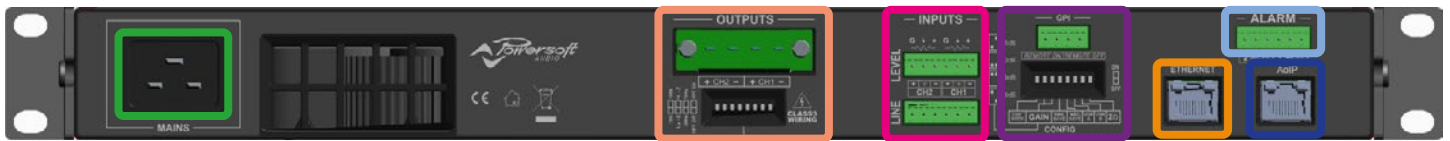

Output section

- 10 Output connector
- 11 Output configuration Dip Switches

AC Mains Connector

IEC C19

	Low-Z	High-Z	100V	70V	HPF @ 35 Hz	HPF @ 70 Hz
A	•					
B		•	•			
C		•	•		•	
D		•	•			•
E		•		•		
F		•		•	•	
G		•		•		•

Bias D1+
Single Ended
(Flipped view)

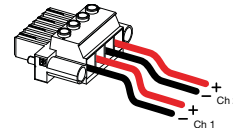

Bias Q1+/Q1.5+/Q2+
Single Ended
(Flipped view)

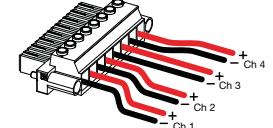

Bridged
(Flipped view)

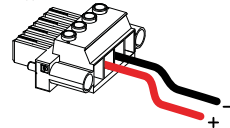

Bridged
(Flipped view)

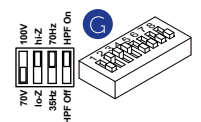
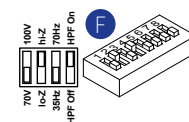
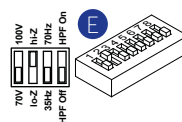
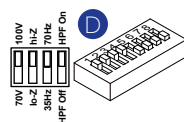
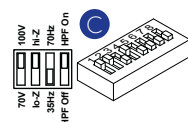
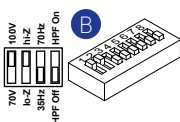
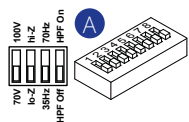
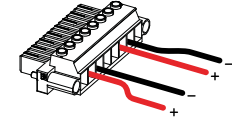

LED Charts

LED Bars, signal metering

8

Color	Signal Metering	Lighting	Warnings Description
ORANGE	Clipping *DSP+D User Limiter	—	—
YELLOW	-6dB	SOLID ON FLASHING	Thermal warning Thermal protection engaged Auto Standby
GREEN	-12dB	—	—
GREEN	-24dB	—	—
GREEN	-60dB	SOLID ON	Signal presence
GREEN	—	BLINKING	Channel muted
GREEN	—	SOLID ON	Channel ready
RED	—	SOLID ON	Channel fault ¹

¹ Red LED lights on in case of any kind of channel fault that prevents the normal channel operating.

Lighting	Timings	Description
FLASHING	100 ms ON 900 ms OFF	
BLINKING	500 ms ON 500 ms OFF	

LED Bar, system status

9

Color	Name	Lighting	Warnings Description
ORANGE	LIMIT	FLASHING SOLID ON	Breaker Save Enabled Breaker Save limiting power draw
YELLOW	TEMP	SOLID ON	Thermal warning Thermal protection engaged
ORANGE	CHECK	SOLID ON BLINKING FAST BLINKING	System self checking Self check completed Self Check Unavailable
GREEN	REMOTE	SOLID ON OFF	Connected to Armonia Pro Audio Not connected to Armonia Pro Audio
GREEN	POWER ON	SOLID ON OFF	System ready System off
GREEN	MAINS	SOLID ON OFF FLASHING FAST BLINKING BLINKING	AC mains voltage within the operating range Undervoltage Over/Undervoltage Warning Overvoltage Mains FUSES blown
RED	ALARM	SOLID ON	PSU fault ¹ OR Critical Faults

¹ Red LED lights on in case of any kind of PSU fault that prevents normal operating.

Lighting	Timings	Description
FLASHING	100 ms ON 400 ms OFF	
FAST BLINKING	100 ms ON 100 ms OFF	
BLINKING	500 ms ON 500 ms OFF	

Operating mode LEDs

1

Color	Name	Operating mode	
		Standby	Power On
GREEN	POWER ON	—	SOLID ON
ORANGE	STANDBY	SOLID ON	—
ORANGE	AUTO STANDBY	BLINKING	—
ORANGE	ERROR CODE	BLINK COUNTER	—

Control Panel

Label	Label	Type	Action	Description
2	POWER	Pushbutton	keep pressed for 3 seconds	Toggle system ready/standby mode
3	CALL	Pushbutton	press	Highlight the amplifier in the Armonia workspace
4	SOFT RESET ¹	Pushbutton	keep pressed for 3 seconds	Reset network parameters to factory default
5	HARD RESET ¹	Pushbutton	keep pressed for 3 seconds	Reboot the system
6	CHECK	Pushbutton	keep pressed for 3 seconds	Start the self-checking procedure*
7	CH1 ²	Potentiometer	turn counter-clockwise	Attenuate the output level of the signal on channel 1
	CH2 ²	Potentiometer	turn counter-clockwise	Attenuate the output level of the signal on channel 2

The push-buttons are disabled when connected to Armonia.

- Keep pressed both the SOFT RESET button and the HARD RESET button for at least 3 seconds to completely reset the amplifier to its factory default configuration (this won't delete any preset stored in the internal memory).
 - The potentiometer is in series with the remote level control so it can be used to limit the output volume regardless of any remote adjustment.
- * Press again to resume normal operations

Self Check

6

	System OK.
	Power supply fault
	AC Mains voltage out of range (over/under voltage)
	PSU temperature out of range
	Fan Error
	Channel# Output Waveform non-conformity
	Channel# Temperature out of range
	Channel# Output current measurement non-conformity ¹

- An 8Ω dummy load is needed to measure the output current. If the dummy load is not applied the system reports a fault.

NORTH AMERICA

Void Acoustics North America

Call: +1(630) 6866616

Email: hello@voidacoustics.com

HEAD OFFICE

Void Acoustics Research Ltd,
Unit 15, Dawkins Road Industrial Estate,
Poole, Dorset,
BH15 4JY
United Kingdom

Call: +44(0) 1202 666006

Email: hello@voidacoustics.com



Hear. Feel. Connect.

voidacoustics.com
