



4 Port IPower Switch

User Manual

Benutzerhandbuch

Manuel Utilisateur

Manuale

Manual del Usuario

Instrukcja obsługi

English

Deutsch

Français

Italiano

Español

Polski

No.32622

lindy.com

Introduction

Thank you for purchasing the 4 Port IPower Switch. This product has been designed to provide trouble free, reliable operation. It benefits from both a LINDY 3 year warranty and free lifetime technical support. To ensure correct use, please read this manual carefully and retain it for future reference.

This IPower Switch is designed for power control and monitoring via TCP/IP to provide convenient remote control power management. System administrators can control the power to multiple devices, workstations, switches, router etc. allowing power-on and off functions with power consumption monitoring via a simple to use web GUI, RS-232 or API commands.

Safety Instructions

! WARNING !

Please read the following safety information carefully and always keep this document with the product.

Failure to follow these precautions can result in serious injuries or death from electric shock, fire or damage to the product.



This device has a switching type power supply and can work with supply voltages in the range 110...250 VAC.

Touching the internal components or a damaged cable may cause electric shock, which may result in death.

To reduce risk of fire, electric shocks or damage:

- Do not open the product. There are no user serviceable parts inside.
- Only qualified servicing personnel may carry out any repairs or maintenance.
- Never use damaged cables.
- Do not expose the product to water or places of moisture.
- Do not use this product outdoors it is intended for indoor use only.
- Do not place the product near direct heat sources. Always place it in a well-ventilated place.
- Do not place heavy items on the product or the cables.
- Please ensure any cables are firmly secured and locked in place before inserting into a power socket

Safety and Health Information: LINDY products are designed for safe, effective use. Please review this guide for essential safety, health information, and details on the Limited Warranty for your product. Following these setup, usage, and care instructions enhances comfort, productivity, and safety. Failure to adhere to these guidelines may result in electric shock, fire, serious injury, or damage to the product or property. Additional support is available at lindy.com.

Warning: Keep out of reach of children. LINDY products and accessories are not toys and should not be handled by young children, as they may cause injury or damage

Suffocation Hazard: For products containing or supplied in plastic bags, keep bags away from babies and children to prevent suffocation.

Power Supply Safety: Applies to products using an AC power supply. Use only the original or compatible AC power supply specified for your product. Failure to follow this guidance may result in electric shock, fire, serious injury, or product damage.

Proper Usage: Keep the device away from moisture, including rain, snow, or water, and avoid placing it near heat sources, food, excessive dirt, dust, oil, chemicals, or direct sunlight. For devices with ports, avoid inserting objects, allowing dust to accumulate, or using heat sources like hair dryers or microwaves to dry it. If the device becomes wet, gently wipe the exterior with a dry cloth.

High-Risk Use: This product is not intended for applications where failure could lead to death, serious injury, or significant environmental harm ("high-risk use"). Use in such applications is solely at your own risk.

Explosive Atmospheres: Do not store or transport flammable or explosive materials alongside this product or its accessories. Always unplug and power off the product, and avoid charging in areas with potentially explosive atmospheres.

Cable Connectors and Ports: To prevent shock or fire when using connectors with a power supply, avoid contact during use. Keep connectors free from moisture, dirt, and contaminants. Discontinue use and contact support if any connector appears damaged.

Cleaning: To minimize risks of fire, electric shock, or product damage, unplug all cables and power off the device and accessories before cleaning. Use a dry cloth to clean the exterior only. Avoid inserting objects into ports, and do not immerse connectors in liquids; instead, wipe and dry them thoroughly.

Risk in Repairs: Attempting to open or repair this product may expose you to risks of electric shock, fire, or injury. LINDY strongly recommends using professional repair services, as unauthorized repairs may void your warranty.

CAUTION

Skin Irritation: This product contains materials commonly used in electronics that may cause skin irritation for some users. To reduce this risk, clean your device regularly, avoid applying lotions near contact areas, and discontinue use if irritation occurs. Consult your health care provider if symptoms persist.

Cable Safety: Exposed cables can pose a tripping hazard. Arrange cables to prevent tripping or pulling risks and protect them from crushing, sharp bends, and heat exposure. Regularly inspect cables and discontinue use if damaged. Unplug cables during lightning storms or for long-term storage.

NOTICE

Heat-Related Concerns: The product may become warm during regular use. Avoid prolonged skin contact, ensure adequate ventilation, and use in well-circulated areas to prevent overheating and discomfort.

Personal Medical Devices: Electronic emissions and magnetic fields from LINDY products may unintentionally interfere with medical devices, despite regulatory compliance. If you suspect interference, turn off the product immediately. For guidance on using electronic devices nearby, consult the manufacturer of your medical device or your healthcare provider.

Handling: Handle your LINDY product with care. The product may be damaged if dropped, punctured, or exposed to liquid. If damage is suspected, stop using the product to prevent potential hazards.

Package Contents

- 4 Port IPower Switch
- Mounting kit with brackets
- RS232 3-pin to DB9 Female cable, 1.35m
- Schuko and UK to IEC C13 power cables, 1.8m
- 4x rubber feet
- Lindy manual

Features

- 4x IEC C13 10A output ports for the devices
 - IEC C14 10A power input
 - Power control, voltage, current and power consumption monitoring
 - Management via web GUI, RS-232, APIs and front panel buttons
 - Telnet, Modbus TCP, SSH, SNMP and MQTT protocols supported
 - 2x redundant RJ-45 network ports
 - Overload and wiring error protection and remote login verification
 - Supports many security, network and IoT protocols
-

Specification

- Power supply: 110-250V 50/60Hz 10A
- No-load power consumption: 1.53W
- Switched power (total): max. 2500W (2640W, 10A@264V by setting the voltage threshold)
- LED Indicators
- Voltage Range: 110~250V (90~264V by setting the voltage threshold)
- Current Range: 0~10A
- Frequency Range: 45~65Hz
- Operating Temperature: -10~55°C (14°F~131°F)
- Storage Temperature: -20~70°C (-4°F~158°F)
- Relative Humidity: 0~95% (non-condensing)

Installation

Front

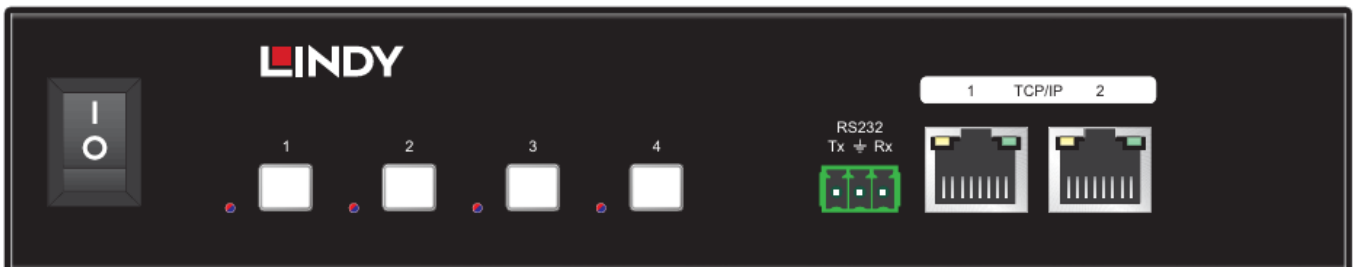

- POWER BUTTON: switch On/Off the unit.
- BUTTON 1-2-3-4: manually power management for each outlet port.
LED status:
Blue: power On
Flashing blue: port initialization before power On
Red: outlet port is overloaded
Flashing red: outlet port is restarting
- RS232: connect to a PC, serial controller or serial device via a phoenix block 3-way connection for the pass-through transmission of RS-232 and API commands.
- TCP/IP 1-2: two redundant RJ-45 port for network connection to have access to the web GUI control.

Rear

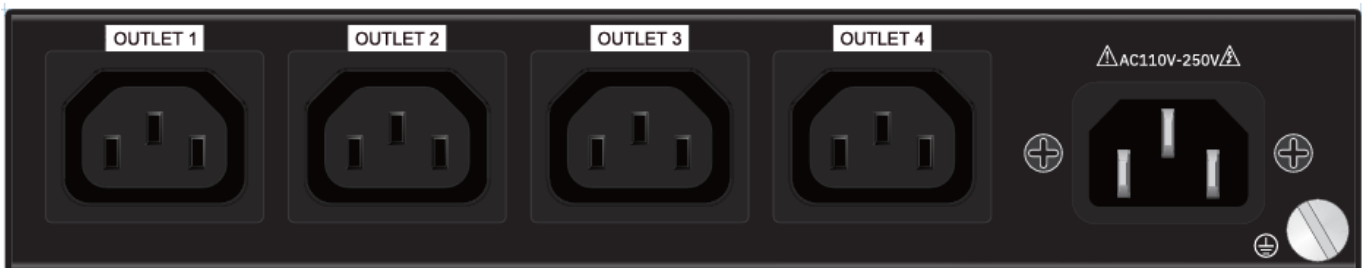

- OUTLET 1-2-3-4: IEC C13 ports to power the connected devices.
- AC 110V~250V: IEC C14 input port to power the unit.

Connect all the devices to the OUTLET ports, then switch on the unit and the devices.

Operation

Web GUI

Connect the TCP/IP RJ-45 port to the local network or connect directly to TCP/IP 1 port. By default the unit is set to DHCP mode. To obtain automatically the dynamically-assigned IP address, connect the unit to a DHCP-enabled network.

Is possible to obtain the current IP address also connecting the unit to the RS232 port and send the >getstatus command, as shown in the screenshot below:

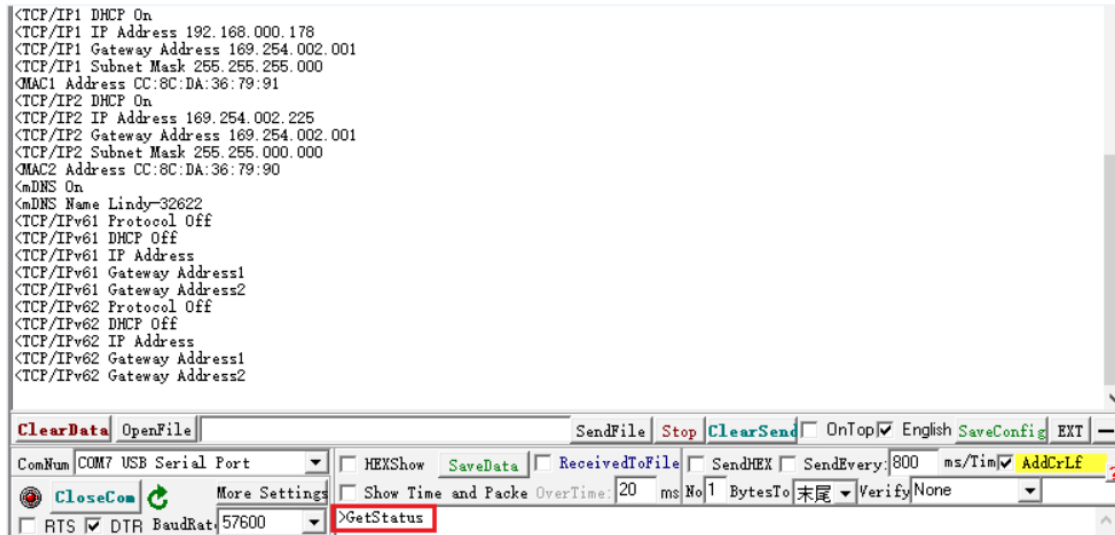

If there is no DHCP server such as a router in the network, the unit will fall back to the following default IP settings:

- Port 1: 192.168.0.178
- Port 2: 169.254.2.225
- Subnet Mask 1: 255.255.255.0
- Subnet Mask 2: 255.255.0.0
- Gateway: 192.168.0.1
- Telnet port: 4001

Type the IP Address in the browser to open the login page.

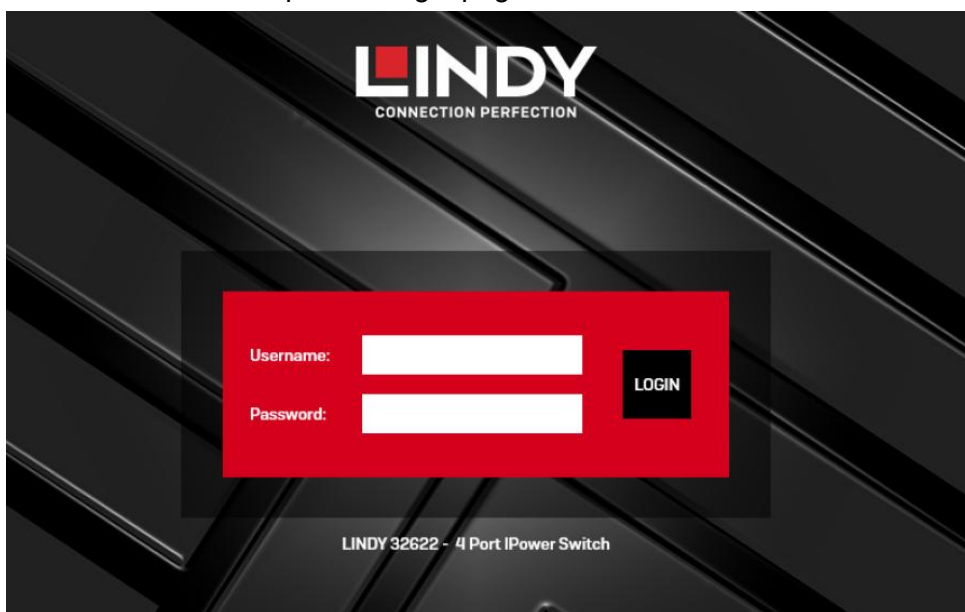

Default Username: admin

Default Password: aP?y43Tq

Type the default username and the password, then click **LOGIN**.

Important: Change the Default Password Immediately

To protect your product and personal data, you must change the default password as soon as possible after setup.

This product complies with the UK Product Security and Telecommunications Infrastructure (PSTI) Regulation, which requires that all default passwords are unique or generated per device. However, to maintain the highest level of security, it is essential that you set your own strong and memorable password.

How to Change Your Password:

1. Power on the device and connect to it using the web interface.
2. Log in using the default credentials as above.
3. Navigate to Security > Web-GUI login pass.
4. Enter your new password and confirm.
5. Save your changes and log in again using the new password.

Tips for a Strong Password:

- Use at least 8 characters (we recommend 12+)
- Include uppercase and lowercase letters
- Add numbers and special characters (!, @, #, etc.)
- Avoid common words or personal information

Failure to change the default password may expose your device to security risks. If you need assistance, please contact our customer support team.

Dashboard

The dashboard features a top navigation bar with tabs for Dashboard, Network, Schedule, Protocols, Email, Clock, System, and Security. The main content area is divided into several sections:

- System Controls:** Includes buttons for 'ALL ON', 'ALL OFF', 'SYSTEM RESTART', and 'ALL METERS RESET'. Below these are summary tables for 'Total Current' (9.9 A), 'Total Power' (2400.0 W), 'Total Energy Consumed' (999999.9 kWh), 'Voltage' (240 V), and 'Frequency' (50 Hz) / 'Power Factor' (0.8). A note indicates 'Energy measured since: 2023-5-1 12:34'.
- Outlet Management:** Four outlet cards (OUTLET 1-4) are displayed. Each card shows a power icon, an 'RS' (Reset) button, and 'ON/OFF' power controls. Below each icon is a table with 'Current' (9.9 A) and 'Power' (2400.0 W). A second table shows 'Vo.' (240V), 'PF' (0.75), and 'Energy Consumed' (999999.9 kWh). A 'Settings' button is located below each outlet card.
- Outlet Settings (OUTLET 1):** A detailed settings panel for the first outlet, including 'Outlet Label' (Outlet 1), 'Outlet Re-Power Delay', 'Outlet Power-Off Delay', and 'Meters Reset Duration', all in seconds. A 'Save Changes' button is at the bottom.

The bottom status bar shows: System Time: 2024-12-11 11:59, Uptime: 90days 12 hrs 59 mins, GUI Version: 1.0.0.1, System auto logout in 15mins, and buttons for 'Maintenance' and 'Logout'.

- **ALL ON/ALL OFF:** power on/off all the 4 outlets.
- **SYSTEM RESTART:** restart the unit.
- **ALL METERS RESET:** reset the meters of the 4 outlets.
- **OUTLET 1-2-3-4**
 - RS:** reset the energy consumed.
 - ON/OFF:** power on/off.
 - Settings:** rename the Outlet, set re-power and power-off delays and set meters reset duration.
 - Save Changes:** click to save the Outlet settings.

Network

Dashboard **Network** Schedule Protocols Email Clock System Security

TCP/IP 1 Settings

Enable TCP/IP 1 ON OFF

Use IPv4 DHCP Yes Use Static IP

MAC Address: 2A:3B:4C:5D:6E:7F

IPv4 Address: 192.168.3.2

IPv4 Netmask: 255.255.0.0

IPv4 Gateway: 192.168.3.0

IPv4 DNS: 8.8.8.8

Save Changes

TCP/IP 2 Settings

Enable TCP/IP 2 ON OFF

Use IPv4 DHCP Yes Use Static IP

MAC Address: 2A:3B:4C:5D:6E:7F

IPv4 Address: 192.168.3.2

IPv4 Netmask: 255.255.0.0

IPv4 Gateway: 192.168.3.0

IPv4 DNS: 8.8.8.8

Save Changes

IPv6 Settings

Ethernet TCP/IP 1 TCP/IP 2

Use IPv6 Protocol Yes No

Use IPv6 Router Advertisement Yes No

IPv6 Settings DHCP v6 Manual

IPv6 Addresses: _____ /64

IPv6 DNS Address 1: _____

IPv6 DNS Address 2: _____

IPv6 Gateway Address 1: _____

IPv6 Gateway Address 2: _____

Save Changes

Reply ICMP PING Yes No

HTTP Server HTTP ONLY HTTPS ONLY

HTTP Server Port: 80

HTTPS Server Port: 443

TLS Versions: TLS 1.2 only

Save Changes

mDNS Yes No

Hostname: 80

Save Changes

System Time: 2024-12-11 11:59 Uptime: 90days 12 hrs 59 mins GUI Version: 1.0.0.1 System auto logout in 15mins Maintenance Logout

Schedule

Dashboard Network **Schedule** Protocols Email Clock System Security

Schedule Settings

ALL OUTLETS

Schedule Timer for: ALL OUTLETS

Turn ON All Time Turn OFF All Time

Turn ON All Time Turn OFF All Time

Please click below numbers to set the whole column to 'ON' or 'OFF'

Date/Hour	0	1	2	3	4	5	6	7	8	9	10	11	12	13	14	15	16	17	18	19	20	21	22	23
MON ▶		Red	Green	Green	Green	Green	Green	Green	Green	Green	Green	Green	Green	Green	Green	Green	Green	Green	Green	Green	Green	Green	Green	Green
TUE ▶		Green	Green	Green	Green	Green	Green	Green	Green	Green	Green	Green	Green	Green	Green	Green	Green	Green	Green	Green	Green	Green	Green	Green
WED ▶		Green	Green	Green	Green	Green	Green	Green	Green	Green	Green	Green	Green	Green	Green	Green	Green	Green	Green	Green	Green	Green	Green	Green
THU ▶		Green	Green	Green	Green	Green	Green	Green	Green	Green	Green	Green	Green	Green	Green	Green	Green	Green	Green	Green	Green	Green	Green	Green
FRI ▶		Green	Green	Green	Green	Green	Green	Green	Green	Green	Green	Green	Green	Green	Green	Green	Green	Green	Green	Green	Green	Green	Green	Green
SAT ▶		Green	Green	Green	Green	Green	Green	Green	Green	Green	Green	Green	Green	Green	Green	Green	Green	Green	Green	Green	Green	Green	Green	Green
SUN ▶		Green	Green	Green	Green	Green	Green	Green	Green	Green	Green	Green	Green	Green	Green	Green	Green	Green	Green	Green	Green	Green	Green	Green

Please click above week days to set the whole row to 'ON' or 'OFF'. Green box: Power ON Red box: Power OFF

Please click above little squares to set schedule individually, once save changes, new schedule will be activated from next planning hour or after system reboot.

Save Changes

System Time: 2024-12-11 11:59 Uptime: 90days 12 hrs 59 mins GUI Version: 1.0.0.1 System auto logout in 15mins Maintenance Logout

Select the outlets and schedule the on/off status by days and hours (green is on, red is off).

Protocols

Dashboard	Network	Schedule	Protocols	Email	Clock	System	Security
-----------	---------	----------	------------------	-------	-------	--------	----------

SNMP | Telnet | MQTT | SSH | Modbus TCP

Enable SNMP V1 Options SNMP GET SNMP SET

SNMP UDP Port

sysContact

sysName

sysLocation

Enable SNMP V2C Yes No

Enable SNMP V3 Yes No

Enable SNMP Trap V1 Trap V2C Trap V3 Trap
 Disable SNMP Trap

SNMP Trap Receiver 1

SNMP Trap Receiver 2

System Time: 2024-12-11 11:59 Uptime: 90days 12 hrs 59 mins GUI Version: 1.0.0.1 System auto logout in 15mins

Select the protocols available between SNMP, Telnet, MQTT, SSH and Modbus TCP to establish the needed connection. Each window provides the configuration of the protocol selected.

Email

Dashboard	Network	Schedule	Protocols	Email	Clock	System	Security
-----------	---------	----------	-----------	--------------	-------	--------	----------

SMTP Settings

SMTP Server

SMTP Server Port

Connection Encryption NONE SSL/TLS STARTTLS

Enable SMTP Authentication Yes No

Username

Password

Repeat Password

Default Sender Name

Send System Daily Reports Yes No
Report send only when alarm happens if not tick Yes.

Daily Report Time (hh:mm)

Email Testing

SMTP Setting must be completed before email testing.

To Recipients

Seperate by ',' to send multiple recipients, for example: user1@email.com,user2@email.com

From Sender

Fill in custom email sender address, leave blank by using default address

Custom Email Content

Email Topic

Using system default topic when custom topic is no set.

To Recipients

Seperate by ',' to send multiple recipients, for example: user1@email.com,user2@email.com

System Time: 2024-12-11 11:59 Uptime: 90days 12 hrs 59 mins GUI Version: 1.0.0.1 System auto logout in 15mins

Setup the Email server and account to receive warnings and reports.

Clock

Dashboard Network Schedule Protocols Email **Clock** System Security

NTP Settings

Enable NTP Server Yes No

Primary NTP Server

Secondary NTP Server

Timezone

Daylight Saving Time (DST) Yes No

Clock Format 12-hour 24-hour

Save Changes

Manual Settings

Set Date Manually (yyyy-mm-dd)

Set Time Manually (hh:mm)

Clock Format 12-hour 24-hour

Save Changes

System Time: 2024-12-11 11:59 Uptime: 90days 12 hrs 59 mins GUI Version: 1.0.0.1 System auto logout in 15mins Maintenance Logout

Configure the time settings manually or via internet connection by enabling NTP server.

System

Dashboard Network Schedule Protocols Email Clock **System** Security

System Settings

Front Panel Lock Yes No

Device Name

Login Timeout min (Default: 15mins)

Warning Beeper Time s (Default: 10s)

Standby Mode Standby Mode Sleep Mode

Save Changes

Overload Processing Power off the overloaded outlet

Power off all outlets, then system standby

Auto recover retries, in mins (1-10, Default 3)

Overcurrent Threshold A (Max. 10.9A)

Save Changes

System Time: 2024-12-11 11:59 Uptime: 90days 12 hrs 59 mins GUI Version: 1.0.0.1 System auto logout in 15mins Maintenance Logout

System settings page, unlock the front panel buttons, login timeout, warning beeper time, overload processing and overcurrent threshold.

Security

Security settings, change the login password and radius client parameters.

Maintenance

Click on Maintenance button to view system logs, firmware update, upload SSL certificate, import and export config, restart device, factory reset and flush DNS cache.

Commands

Port 1 IP address: 192.168.0.178

Port 2 IP address: 169.254.2.225

Telnet port: 4001

Baudrate: 57600 (default)

Data bit: 8

Stop bit:1

Check bit: none

Terminator: <CR><LF>

Error command feedback code: <Command Error <Out of Range

Command	Function	Example	Feedback
>?/Help	List all the command	>? >Help	All the commands list
>GetStatus	Check the status of the device.	>GetStatus	<Lindy-32622 <V1.0.0a <GetPowerStatus On <GetKeyStatus On <GetTCP/IPEnable 1 <GetRS232Baud 57600 <GetSystemCurrentThreshold 10.9A <Outlet 1 Off <Outlet 2 Off <Outlet 3 Off <Outlet 4 Off <GetGroundStatus Properly Grounded <GetOutletMode 1 Idle <GetOutletMode 2 Idle <GetOutletMode 3 Idle <GetOutletMode 4 Idle <GetOutletPowerOnTime 1 1s <GetOutletPowerOnTime 2 2s <GetOutletPowerOnTime 3 3s <GetOutletPowerOnTime 4 4s <GetOutletPowerOffTime 1 1s <GetOutletPowerOffTime 2 2s <GetOutletPowerOffTime 3 3s <GetOutletPowerOffTime 4 4s <GetOutletEleResetTime 1 10s <GetOutletEleResetTime 2 10s <GetOutletEleResetTime 3 10s <GetOutletEleResetTime 4 10s <GetSafeMode Outlet_Shutdown <GetStandbyMode All_Standby_Mode <GetOverloadRetryCnt 1 <GetOverloadRetryTime 3mins <GetBeeperTime 10s

			<p><TCP/IP1 DHCP Off <TCP/IP1 IP Address 169.254.000.178 <TCP/IP1 Gateway Address <TCP/IP1 Subnet Mask 255.255.000.000 <MAC1 Address CC:8C:DA:00:00:00 <TCP/IP2 DHCP Off <TCP/IP2 IP Address 192.168.000.200 <TCP/IP2 Gateway Address 192.168.000.001 <TCP/IP2 Subnet Mask 255.255.255.000 <MAC2 Address CC:8C:DA:00:00:00 <mDNS Off <mDNS Name Lindy-32622 <TCP/IPv61 Protocol Off <TCP/IPv61 DHCP Off <TCP/IPv61 IP Address <TCP/IPv61 Gateway Address1 <TCP/IPv61 Gateway Address2 <TCP/IPv62 Protocol Off <TCP/IPv62 DHCP Off <TCP/IPv62 IP Address <TCP/IPv62 Gateway Address1 <TCP/IPv62 Gateway Address2</p>
<p>>GETOUTLETSTAT US</p>	<p>Check the status of a single outlet. >GETOUTLETSTATUS [Param1] [Param1] = 0-4</p>	<p>>GETOUTLETSTATUS 1</p>	<p><Outlet 1 On</p>
<p>>GetElesta</p>	<p>Check the electricity information, such as power consumption, voltage, current, etc.</p>	<p>>GetElesta</p>	<p>< Lindy-32622 <V1.0.0a <Total Current 0.000A <Total Power 0.000W <Total Energy Consumed 0.000000kWh <Voltage 232.199V <Frequency 49.54Hz <Power Factor 0.00 <GetOutletVoltage 1 0.000V <GetOutletVoltage 2 0.000V <GetOutletVoltage 3 0.000V <GetOutletVoltage 4 0.000V <GetOutletCurrent 1 0.000A <GetOutletCurrent 2 0.000A <GetOutletCurrent 3 0.000A <GetOutletCurrent 4 0.000A <GetOutletPower 1 0.000W <GetOutletPower 2 0.000W <GetOutletPower 3 0.000W <GetOutletPower 4 0.000W <GetOutletConsumed 1 0.000000kWh <GetOutletConsumed 2 0.000000kWh</p>

			<GetOutletConsumed 3 0.000000kWh <GetOutletConsumed 4 0.000000kWh <GetOutletPowerFactor 1 0.00 <GetOutletPowerFactor 2 0.00 <GetOutletPowerFactor 3 0.00 <GetOutletPowerFactor 4 0.00
>GetFwVersion	Check the firmware version.	>GetFwVersion	<FW VersiOn: V1.0.0a <GUI VersiOn: V1.0.0a
>SetDeviceName	Set a nickname for the device. >SetDeviceName: [Param1] [Param1] should be the nickname you want to set. (14 characters maximum)	>SetDeviceName: Lindy-32622	<Device Name: Lindy-32622
>SetPower	Enter/Exit the standby mode. >SetPower [Param1] [Param1] = On,Off On - Power on Off - Power off	>SetPower On >SetPower Off	<System Power Off <System Power On, Please Wait A Moment... Done
>SetKeyLock	To lock/unlock the button on the front panel of the device. >SetKeyLock [Param1] [Param1] = On,Off On-GetKeyStatus Off Off- GetKeyStatus On	>SetKeyLock On >SetKeyLock Off	<KeyLock On <KeyLock Off
>SetCurrentThreshold	Set a current threshold for the system. >SetCurrentThreshold [Param1] [Param1] = 0.0-10.9	>SetCurrentThreshold 10	<System Current Threshold 10.0A
>SetVoltageThreshold	Set a voltage threshold for the system. >SetVoltageThreshold [Param1] [Param1] =198-264	>SetVoltageThreshold 264	<System Voltage Threshold 264V
>SetSafeMode	Set an action of what the system will do when it goes overloaded. >SetSafeMode [Param1] [Param1] = 0-2 0: Outlet_Shutdown 1: System_Shutdown 2:Auto_Retry	>SetSafeMode 0 >SetSafeMode 1 >SetSafeMode 2	<System Safe Mode: Outlet_Shutdown <System Safe Mode: System_Shutdown <System Safe Mode: Auto_Retry
>SetOverloadRetryCnt	Set how many time the system will reboot when it goes overloaded. >SetOverloadRetryCnt [Param1] [Param1] = 1-3 1(Default)	>SetOverloadRetryCnt 1 >SetOverloadRetryCnt 2 >SetOverloadRetryCnt 3	<System Retry Number 1 <System Retry Number 2 <System Retry Number 3
>SetOverloadRetryTime	Set a delayed time for the system to reboot when it goes overloaded. (unit is minutes) >SetOverloadRetryTime [Param1] [Param1] = 1-10 3(Default)	>SetOverloadRetryTime 1	<System Retry Delay Time 1mins
>SetStandbyMode	Set a standby mode for the system. >StandbyMode [Param1] [Param1] = 0-1 0: All_Standby_Mode (GUI is not responsive) 1: Sleep_Mode (GUI is responsive, no data exchange with MCU)	>SetStandbyMode 0 >SetStandbyMode 1	<System Standby Mode: All_Standby_Mode <System Standby Mode: Sleep_Mode

<p>>SetRs232Baud</p>	<p>Set a baudrate for RS232 >SetRs232Baud [Param1] [Param1] = 1-7 1: 2400 2: 4800 3: 9600 4: 19200 5: 38400 6: 57600(Default), 7: 115200</p>	<p>>SetRs232Baud 6</p>	<p><RS232Baud 57600</p>
<p>>SetRs232Out</p>	<p>RS232 Passthrough >SetRs232Out [Param1][Param2][Param3][Param4]] [Param1] = a,h a: ASCII h: HEX [Param2] = 1-7 1: 2400 2: 4800 3: 9600 4: 19200 5: 38400 6: 57600(Default), 7: 115200 [Param3] = 1-3 1: None 2: Even 3: Odd Param4 = string</p>	<p>>SETRs232OUT a:6:1:RS232</p>	<p>RS232</p>
<p>>SetBeeperTime</p>	<p>Set buzzer duration of time. (unit is seconds) >SetBeeperTime [Param1] [Param1] = 0: 9999 10(Default)</p>	<p>>SetBeeperTime 10</p>	<p><Buzzer Sound Time 10s</p>
<p>>SetOutletTime</p>	<p>Set a dealy time for an outlet to turn on/off. (unit is seconds) >SetOutlet[Param1]Time [Param2][Param3] [Param1] =On,Off [Param2] = 1-4 1: Outlet1 2: Outlet2 3: Outlet3 4: Outlet4 [Param3] = 2-9999 (On)/ 0-9999 (Off)</p>	<p>>SetOutletOnTime 1:1 >SetOutletOffTime 1:1</p>	<p><Outlet 1 Power_On Delay 1s <Outlet 1 Power_Off Delay 1s</p>
<p>>SetOutletEleResetTime</p>	<p>Set a delay time to reset the values of a specific outlet on GUI. >SetOutletEleResetTime[Param1][Param2] [Param1] = 1-4 1: Outlet1 2: Outlet2 3: Outlet3 4: Outlet4 [Param2] = 0-9999 10(Default)</p>	<p>>SetOutletEleResetTime 1:10</p>	<p><Outlet 1 Electrical Work Reset Duration 10s</p>
<p>>SetAllOut</p>	<p>Turn on/off all the outlets. >SetAllOut [Param1] [Param1] = On,Off</p>	<p>>SetAllOut On >SetAllOut Off</p>	<p><All Outlets On <All Outlets Off</p>

>SetOutlet	Turn on/off a single outlet. >SetOutlet [Param1][Param2] [Param1] = 1-4 1: Outlet1 2: Outlet2 3: Outlet3 4: Outlet4 [Param2] = On,Off	>SetOutlet 1 On	<Outlet 1 On
>RsAllOutEle	Reset the metered values displayed on the GUI for all outlets.	>RsAllOutEle	<Clean Up Electrical Work: All Outlets
>RsOutEle	Reset the metered values displayed on the GUI for a specific outlet. >RsOutEle [Param1] [Param1] = 1-4 1: Outlet1 2: Outlet2 3: Outlet3 4: Outlet4	>RsOutEle 1	<Clean Up Electrical Work: Outlet 1
>GetSysTime	Get the time of the date and time of the system.	>GetSysTime	<GetSystemTime: 2023-05-11 02:47:16 Thu
>SetSysTime	Set the date and time for the device: >SetSysTime [Param1] [Param1] = year-month-day;hour-minutes-seconds	>SetSysTime 2025-03-18;11-26-59	<SetSystemTime: 2025-03-18 11:26:59
>SetNetTcp/IpEnable	Enable/Disable the TCP/IP: >SetNetTcp/IpEnable [Param1] [Param1] = 1-2 1: TCP/IP1 2: TCP/IP2	>SetNetTcp/IpEnable 1 >SetNetTcp/IpEnable 2	<TCP/IP1 Enable <TCP/IP2 Enable
>SetNetTcp/Ip1Dhcp	Turn on/off the DHCP for TCP/IP1: >SetNetTcp/Ip1Dhcp [Param1] [Param1] = On,Off	>SetNetTcp/Ip1Dhcp On >SetNetTcp/Ip1Dhcp Off	<TCP/IP1 DHCP On <TCP/IP1 DHCP Off
>SetNetTcp/Ip1Ip	Set an IP address for TCP/IP1: >SetNetTcp/Ip1Ip [Param1] [Param1] = XXX.XXX.XXX.XXX	>SetNetTcp/Ip1Ip 192.168.000.001	<TCP/IP1 IP Address 192.168.000.001
>SetNetTcp/Ip1Gw	Set a gateway for TCP/IP1: >SetNetTcp/Ip1Gw [Param1] [Param1] = XXX.XXX.XXX.XXX	>SetNetTcp/Ip1Gw 192.168.000.254	<TCP/IP1 Gateway Address 192.168.000.254
>SetNetTcp/Ip1Sm	Set a subnet mask for TCP/IP1: >SetNetTcp/Ip1Sm [Param1] [Param1] = XXX.XXX.XXX.XXX	>SetNetTcp/Ip1Sm 192.168.000.254	<TCP/IP1 Subnet Mask 192.168.000.254
>SetNetTcp/Ip2Dhcp	Turn on/off the DHCP of TCP/IP2: >SetNetTcp/Ip2Dhcp [Param1] [Param1] = On,Off	>SetNetTcp/Ip2Dhcp On >SetNetTcp/Ip2Dhcp Off	<TCP/IP2 DHCP On <TCP/IP2 DHCP Off
>SetNetTcp/Ip2Ip	Set an IP address for TCP/IP2: >SetNetTcp/Ip2Ip [Param1] [Param1] = XXX.XXX.XXX.XXX	>SetNetTcp/Ip2Ip 192.168.000.001	<TCP/IP2 IP Address 192.168.000.001
>SetNetTcp/Ip2Gw	Set the gateway for TCP/IP2: >SetNetTcp/Ip2Gw [Param1] [Param1] = XXX.XXX.XXX.XXX	>SetNetTcp/Ip2Gw 192.168.000.254	<TCP/IP2 Gateway Address 192.168.000.254
>SetNetTcp/Ip2Sm	Set the subnet mask for TCP/IP2 >SetNetTcp/Ip2Sm [Param1] [Param1]	>SetNetTcp/Ip2Sm 192.168.000.254	<TCP/IP2 Subnet Mask 192.168.000.254
>SetNetMdns	Turn on/off the mDNS >SetNetMdns [Param1] [Param1] = On,Off	>SetNetMdns On >SetNetMdns Off	<mDNS On <mDNS Off
>SetNetRb	Reboot the IP service	>SetNetRb	<Network Reboot And Apply New Config
>SetNetTcp/Ipv61Protocol	Turn on/off the TCP/IPv61 Protocol >SetNetTcp/Ipv61Protocol [Param1] [Param1] = On,Off	>SetNetTcp/Ipv61Protocol On	<TCP/IPv6 1 Protocol On <TCP/IPv6 1 Protocol Off

		>SetNetTcp/Ipv61Protocol Off	
>SetNetTcp/Ipv61Dhcp	Turn on/off the DHCP for TCP/IPv61 >SetNetTcp/Ipv61Dhcp [Param1] [Param1] = On,Off	>SetNetTcp/Ipv61Dhcp On >SetNetTcp/Ipv61Dhcp Off	<TCP/IPv6 1 DHCP On <TCP/IPv6 1 DHCP Off
>SetNetTcp/Ipv61Ip	Set an IP address for TCP/IPv61 >SetNetTcp/Ipv61Ip [Param1] [Param1] = XXX.XXX.XXX.XXX	>SetNetTcp/Ipv61Ip 192.168.000.001	<TCP/IPv6 1 IP Address 192.168.000.001
>SetNetTcp/Ipv61Gw	Set the gateway for TCP/IPv6: >SetNetTcp/Ipv61Gw [Param1][Param2] [Param1] = 1-2 [Param2] = XXX.XXX.XXX.XXX	>SetNetTcp/Ipv61Gw 1 192.168.000.254 >SetNetTcp/Ipv61Gw 2 192.168.000.254	<TCP/IPv6 1 Gateway Address1 192.168.000.254 <TCP/IPv6 1 Gateway Address2 192.168.000.254
>SetNetTcp/Ipv62Protocol	Turn on/off TCP/IPv62 Protocol >SetNetTcp/Ipv62Protocol [Param1] [Param1] = On,Off	>SetNetTcp/Ipv62Protocol On >SetNetTcp/Ipv62Protocol Off	<TCP/IPv6 2 Protocol On <TCP/IPv6 2 Protocol Off
>SetNetTcp/Ipv62Dhcp	Turn on/off the TCP/IPv62 DHCP >SetNetTcp/Ipv62Dhcp [Param1] [Param1] = On,Off	>SetNetTcp/Ipv62Dhcp On >SetNetTcp/Ipv62Dhcp Off	<TCP/IPv6 2 DHCP On <TCP/IPv6 2 DHCP Off
>SetNetTcp/Ipv62Ip	Set an IP address for TCP/IPv62 >SetNetTcp/Ipv62Ip [Param1] [Param1] = XXX.XXX.XXX.XXX	>SetNetTcp/Ipv62Ip 192.168.000.001	<TCP/IPv6 2 IP Address 192.168.000.001
>SetNetTcp/Ipv62Gw	Set the gateway for TCP/IPv62: >SetNetTcp/Ipv62Gw [Param1][Param2] [Param1] = 1-2 [Param2] = XXX.XXX.XXX.XXX	>SetNetTcp/Ipv62Gw 1 192.168.000.254 >SetNetTcp/Ipv62Gw 2 192.168.000.254	<TCP/IPv6 2 Gateway Address1 192.168.000.254 <TCP/IPv6 2 Gateway Address2 192.168.000.254
>FactoryReset	Factory Reset the device.	>FactoryReset	<FactoryReset
>Reboot	Restart the MCU and GUI	>Reboot	<Reboot
>Resta	Restart MCU	>Resta	<System Restart

Lindy regularly checks and tests our product range to ensure maximum compatibility and performance. For the most up to date version of this manual, please refer to your local Lindy website, search for the relevant part number and find the manual under Downloads.

Einführung

Wir freuen uns, dass Ihre Wahl auf ein LINDY-Produkt gefallen ist und danken Ihnen für Ihr Vertrauen. Sie können sich jederzeit auf unsere Produkte und einen guten Service verlassen. Dieser 4 Port IPower Switch unterliegt einer LINDY Herstellergarantie von 3 Jahren und lebenslangem, kostenlosen technischen Support. Bitte lesen Sie diese Anleitung sorgfältig und bewahren Sie sie auf.

Dieser IPower Switch ist für die Stromsteuerung und -überwachung über TCP/IP konzipiert und ermöglicht eine komfortable Fernsteuerung der Stromversorgung. Systemadministratoren können die Stromversorgung mehrerer Geräte, Workstations, Switches, Router usw. steuern und über eine benutzerfreundliche Web-GUI, RS-232- oder API-Befehle ein- und ausschalten sowie den Stromverbrauch überwachen.

Sicherheitshinweise

! GEFAHR !

Bitte lesen Sie die folgenden Sicherheitshinweise sorgfältig durch und bewahren Sie dieses Dokument immer zusammen mit dem Produkt auf.

Die Nichtbeachtung dieser Vorsichtsmaßnahmen kann zu schweren Verletzungen oder zum Tod durch Stromschlag, Feuer oder Schäden am Produkt führen.

Dieses Gerät verfügt über ein Schaltnetzteil und arbeitet mit Anschlussspannungen im Bereich von 100...250 VAC.

Das Berühren interner Komponenten oder eines beschädigten Kabels kann einen elektrischen Schlag verursachen, der zum Tod führen kann.

Um die Gefahr von Bränden, Stromschlägen oder Schäden zu verringern:

- Öffnen Sie das Produkt nicht. Es befinden sich keine vom Benutzer zu wartenden Teile im Inneren.
- Ausschließlich qualifiziertes Personal darf Reparaturen oder Wartungen durchführen.
- Verwenden Sie niemals beschädigte Kabel.
- Setzen Sie das Produkt nicht Wasser oder Feuchtigkeit aus.
- Dieses Produkt ist nur für den Gebrauch in geschlossenen Räumen bestimmt.
- Stellen Sie das Produkt nicht in der Nähe von direkten Wärmequellen auf. Stellen Sie es immer an einem gut belüfteten Ort auf.
- Stellen Sie keine schweren Gegenstände auf das Produkt oder die Kabel.
- Vergewissern Sie sich vor dem Anschluss an eine Steckdose, dass alle Kabel sicher angeschlossen sind.

Sicherheits- und Gesundheitsinformationen: LINDY Produkte sind für den sicheren und effektiven Gebrauch konzipiert. In dieser Anleitung finden Sie wichtige Sicherheits- und Gesundheitsinformationen sowie Einzelheiten zur beschränkten Garantie für Ihr Produkt. Die Befolgung dieser Aufbau-, Gebrauchs- und Pflegeanweisungen erhöht den Komfort, die Produktivität und die Sicherheit. Die Nichtbeachtung dieser Richtlinien kann zu einem elektrischen Schlag, Brand, schweren Verletzungen oder Schäden am Produkt oder Eigentum führen. Zusätzliche Unterstützung finden Sie unter www.lindy.com.

Warnung: Außerhalb der Reichweite von Kindern aufbewahren. LINDY Produkte und Zubehör sind kein Spielzeug und sollten nicht von kleinen Kindern angefasst werden, da sie Verletzungen oder Schäden verursachen können.

Erstickungsgefahr: Bei Produkten, die Plastiktüten enthalten oder in solchen geliefert werden, halten Sie die Tüten von Babys und Kindern fern, um Erstickungsgefahr zu vermeiden.

Sicherheit der Stromversorgung: Gilt für Produkte, die mit einem Wechselstromnetzteil betrieben werden. Verwenden Sie nur das für Ihr Produkt angegebene Originalnetzteil oder ein kompatibles Netzteil. Die Nichtbeachtung dieses Hinweises kann zu einem elektrischen Schlag, Brand, schweren Verletzungen oder Produktschäden führen.

Richtige Verwendung: Halten Sie das Gerät von Feuchtigkeit, einschließlich Regen, Schnee oder Wasser, fern und vermeiden Sie die Nähe von Wärmequellen, Lebensmitteln, übermäßigem Schmutz, Staub, Öl, Chemikalien oder direktem Sonnenlicht. Vermeiden Sie bei Geräten mit Anschlüssen das Einstecken von Gegenständen, die Ansammlung von Staub oder die Verwendung von Wärmequellen wie



Haartrocknern oder Mikrowellen zum Trocknen des Geräts. Wenn das Gerät nass geworden ist, wischen Sie es vorsichtig mit einem trockenen Tuch ab.

Risikoreiche Verwendung: Dieses Produkt ist nicht für Anwendungen vorgesehen, bei denen ein Versagen zum Tod, zu schweren Verletzungen oder zu erheblichen Umweltschäden führen könnte („Risikoreiche Verwendung“). Die Verwendung in solchen Anwendungen erfolgt ausschließlich auf eigene Gefahr.

Explosive Atmosphären: Lagern oder transportieren Sie keine entflammbaren oder explosiven Materialien neben diesem Produkt oder seinem Zubehör. Ziehen Sie immer den Netzstecker und schalten Sie das Produkt aus, und vermeiden Sie das Aufladen in Bereichen mit potentiell explosiver Atmosphäre.

Kabelanschlüsse und -buchsen: Um einen Stromschlag oder Brand zu vermeiden, wenn Sie Stecker mit einem Netzteil verwenden, vermeiden Sie den Kontakt während des Gebrauchs. Halten Sie die Anschlüsse frei von Feuchtigkeit, Schmutz und Verunreinigungen. Stellen Sie die Verwendung ein und wenden Sie sich an den Kundendienst, wenn ein Stecker beschädigt erscheint.

Reinigung: Um das Risiko eines Brandes, elektrischen Schlags oder einer Beschädigung des Produkts zu minimieren, ziehen Sie alle Kabel ab und schalten Sie das Gerät und das Zubehör aus, bevor Sie es reinigen. Verwenden Sie nur ein trockenes Tuch, um das Gerät von außen zu reinigen. Führen Sie keine Gegenstände in die Anschlüsse ein, und tauchen Sie die Anschlüsse nicht in Flüssigkeiten ein; wischen Sie sie stattdessen gründlich ab und trocknen Sie sie.

Risiko bei Reparaturen: Wenn Sie versuchen, dieses Produkt zu öffnen oder zu reparieren, besteht die Gefahr eines elektrischen Schlags, eines Brands oder von Verletzungen. LINDY empfiehlt dringend, professionelle Reparaturdienste in Anspruch zu nehmen, da nicht autorisierte Reparaturen zum Erlöschen Ihrer Garantie führen können.

VORSICHT

Hautreizung: Dieses Produkt enthält Materialien, die üblicherweise in der Elektronik verwendet werden und bei manchen Benutzern Hautreizungen hervorrufen können. Um dieses Risiko zu verringern, reinigen Sie Ihr Gerät regelmäßig, vermeiden Sie das Auftragen von Lotionen in der Nähe der Kontaktbereiche und stellen Sie den Gebrauch ein, wenn Reizungen auftreten. Wenden Sie sich an Ihren Arzt, wenn die Symptome fortbestehen.

Kabelsicherheit: Freiliegende Kabel können eine Stolperfalle darstellen. Positionieren Sie die Kabel so, dass sie nicht zur Stolperfalle werden oder versehentlich daran gezogen werden kann und schützen Sie sie vor Quetschungen, Abknicken und Hitzeeinwirkung. Überprüfen Sie die Kabel regelmäßig und verwenden Sie diese nicht mehr, wenn sie beschädigt sind. Ziehen Sie die Kabel bei Gewitter oder bei längerer Lagerung aus der Steckdose.

HINWEIS

Hitzebedingte Bedenken: Das Produkt kann bei regelmäßigem Gebrauch warm werden. Vermeiden Sie längeren Hautkontakt, sorgen Sie für ausreichende Belüftung und verwenden Sie es in gut belüfteten Bereichen, um Überhitzung und Unwohlsein zu vermeiden.

Persönliche medizinische Geräte: Elektronische Emissionen und magnetische Felder von LINDY Produkten können unbeabsichtigt medizinische Geräte stören, obwohl sie den gesetzlichen Vorschriften entsprechen. Wenn Sie eine Störung vermuten, schalten Sie das Produkt sofort aus. Wenden Sie sich an den Hersteller Ihres medizinischen Geräts oder an Ihren medizinischen Betreuer, wenn Sie Hinweise zur Verwendung elektronischer Geräte in der Nähe benötigen.

Handhabung: Behandeln Sie Ihr LINDY Produkt mit Sorgfalt. Das Produkt kann beschädigt werden, wenn es herunterfällt, durchstochen wird oder mit Flüssigkeit in Berührung kommt. Wenn Sie eine Beschädigung vermuten, verwenden Sie das Produkt nicht mehr, um mögliche Gefahren zu vermeiden.

Lieferumfang

- 4 Port IPower Switch
- Montagesatz mit Halterungen
- RS232 3-polig auf DB9 Buchse Kabel, 1.35m
- IEC-C13-Kabel mit Schuko- und UK-Stecker, 1.8m
- 4x Gummifüße
- Lindy Handbuch

Eigenschaften

- 4x IEC C13 10A-Ausgangsanschlüsse für die Geräte
- IEC C14 10A-Stromeingang
- Leistungssteuerung, Überwachung von Spannung, Strom und Leistungsaufnahme
- Verwaltung über Web-GUI, RS-232, APIs und Tasten an der Vorderseite
- Unterstützt Telnet-, Modbus TCP-, SSH-, SNMP- und MQTT-Protokolle
- 2 redundante RJ-45-Netzwerkanschlüsse
- Überlast- und Verkabelungsfehlerschutz und Überprüfung von remote Logins
- Unterstützt zahlreiche Sicherheits-, Netzwerk- und IoT-Protokolle

Spezifikationen

- Stromversorgung: 110–250V, 50/60Hz, 10A
- Leistungsaufnahme (ohne Last): 1.53W
- Schaltleistung (gesamt): max. 2500W (2640W, 10A bei 264V durch Einstellen der Spannungsschwelle)
- LED-Anzeigen
- Spannungsbereich: 110 bis 250V (90 bis 264V durch Einstellen der Spannungsschwelle)
- Strombereich: 0~10A
- Frequenzbereich: 45~65Hz
- Betriebstemperatur: -10–55°C (14°F–131°F)
- Lagertemperatur: -20–70°C (-4°F–158°F)
- Relative Luftfeuchtigkeit: 0–95% (nicht kondensierend)

Installation

Vorderseite

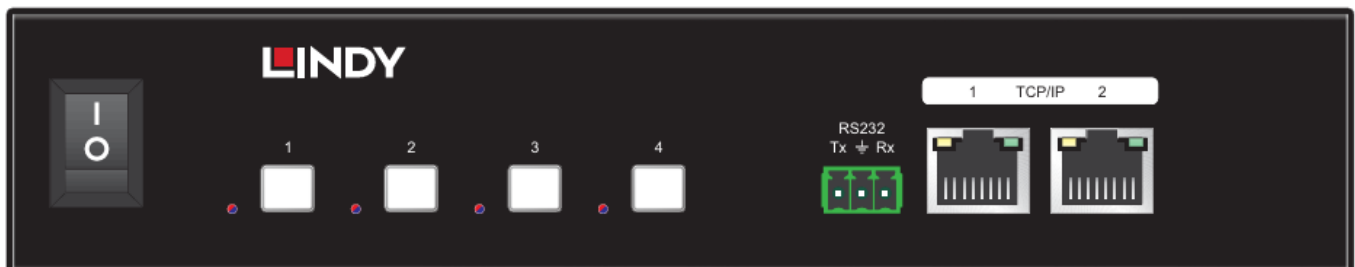

- Power-Taste: Zum Ein- und Ausschalten des Geräts.
- Tasten 1-2-3-4: Manuelle Stromverwaltung für jeden Ausgangsanschluss.
LED-Statusanzeige:
Blau: Gerät eingeschaltet
Blau blinkend: Initialisierung der Anschlüsse vor dem Einschalten
Rot: Ausgangsanschluss überlastet
Rot blinkend: Ausgangsanschluss wird neu gestartet
- RS232: Anschluss an einen PC, einen seriellen Controller oder ein serielles Gerät über einen 3-Wege-Klemmblockanschluss für das Passthrough von RS-232- und API-Befehlen.
- TCP/IP 1-2: Zwei redundante RJ-45-Anschlüsse für den Netzwerkanschluss, um Zugriff auf die Web-GUI-Steuerung zu erhalten.

Rückseite

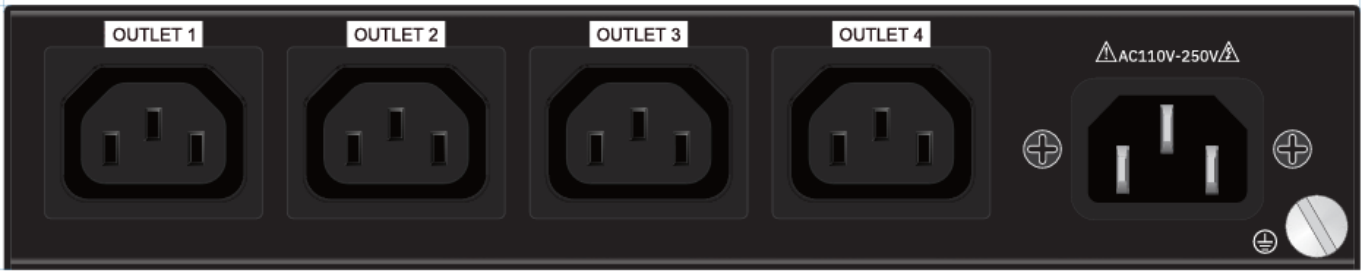

- OUTLET 1-2-3-4: IEC C13-Anschlüsse zur Stromversorgung der angeschlossenen Geräte.
- AC 110V~250V: IEC C14-Eingangsanschluss zur Stromversorgung des Switches.

Schließen Sie alle Geräte an die OUTLET-Anschlüsse an und schalten Sie dann den Switch und die Geräte ein.

Betrieb

Web GUI

Verbinden Sie den TCP/IP-RJ-45-Anschluss mit dem lokalen Netzwerk oder direkt mit dem TCP/IP-1-Anschluss. Standardmäßig ist das Gerät auf den DHCP-Modus eingestellt. Um die dynamisch zugewiesene IP-Adresse automatisch zu erhalten, verbinden Sie das Gerät mit einem DHCP-fähigen Netzwerk.

Die aktuelle IP-Adresse kann auch abgerufen werden, indem Sie das Gerät an den RS232-Anschluss anschließen und den Befehl >getstatus senden, wie in der folgenden Abbildung gezeigt.

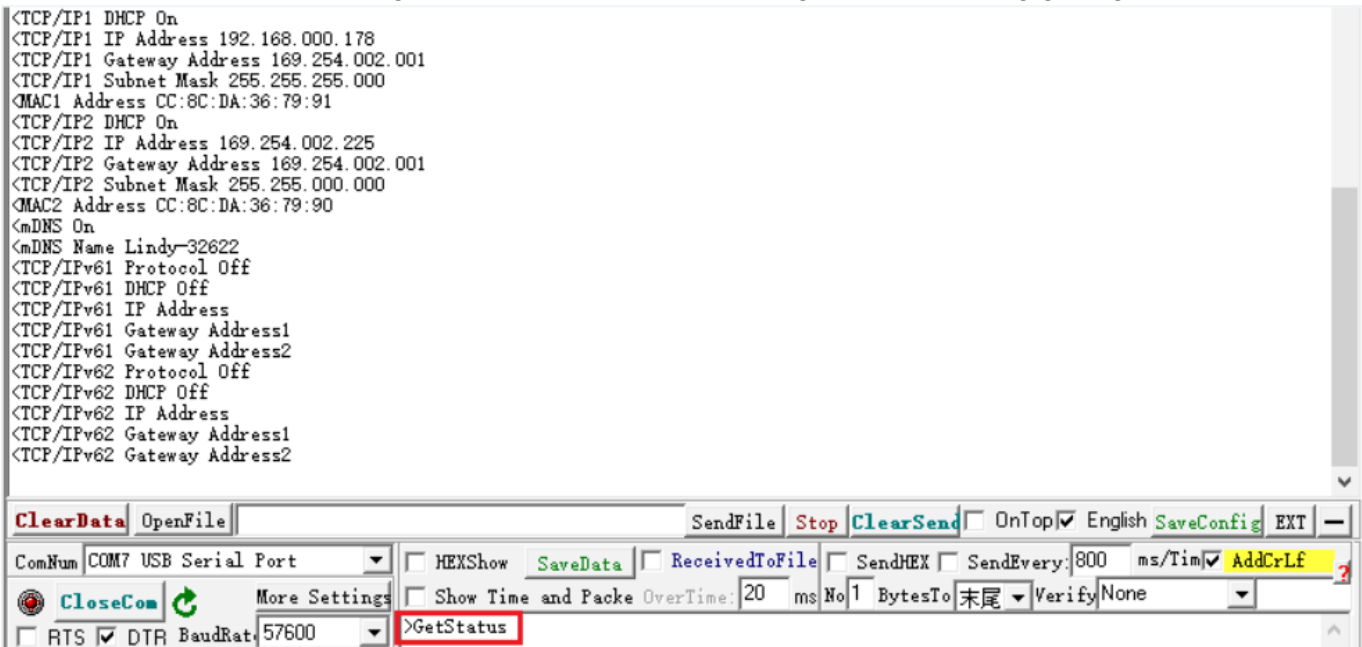

Wenn kein DHCP-Server wie z. B. ein Router im Netzwerk vorhanden ist, greift das Gerät auf die folgenden Standard-IP-Einstellungen zurück:

- Port 1: 192.168.0.178
- Port 2: 169.254.2.225
- Subnetzmaske 1: 255.255.255.0
- Subnetzmaske 2: 255.255.0.0
- Gateway: 192.168.0.1
- Telnet-Port: 4001

Geben Sie die IP-Adresse in den Browser ein, um die Anmeldeseite zu öffnen.

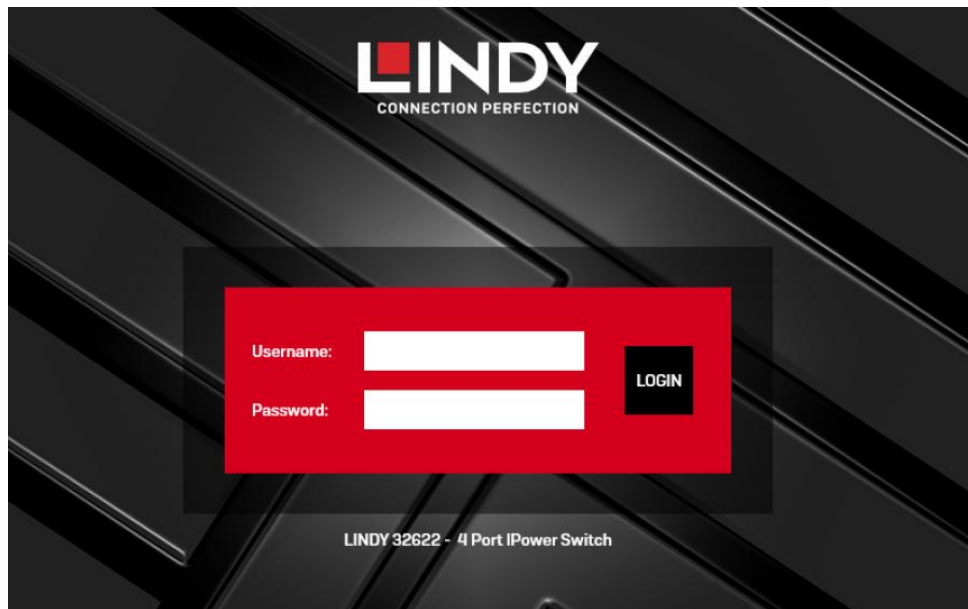

Standard-Benutzername: admin

Standard-Passwort: aP?y43Tq

Geben Sie den Standard-Benutzernamen und das Passwort ein und klicken Sie dann auf **LOGIN**.

Wichtig: Ändern Sie das Standard-Passwort sofort

Um Ihr Produkt und Ihre persönlichen Daten zu schützen, müssen Sie das Standard-Passwort nach der Einrichtung so schnell wie möglich ändern.

Dieses Produkt entspricht der britischen Verordnung über Produktsicherheit und Telekommunikationsinfrastruktur (PSTI), die vorschreibt, dass alle Standard-Passwörter eindeutig sein oder pro Gerät generiert werden müssen. Um jedoch ein Höchstmaß an Sicherheit zu gewährleisten, ist es unerlässlich, dass Sie ein eigenes sicheres und leicht zu merkendes Passwort festlegen.

So ändern Sie Ihr Passwort:

1. Schalten Sie das Gerät ein und stellen Sie über die Webschnittstelle eine Verbindung her.
2. Melden Sie sich mit den oben angegebenen Standardanmeldedaten an.
3. Navigieren Sie zu **Security > Web-GUI login pass**.
4. Geben Sie Ihr neues Passwort ein und bestätigen Sie es durch Eingabe des neuen Passworts.
5. Speichern Sie Ihre Änderungen und melden Sie sich mit dem neuen Passwort erneut an.

Tipps für ein sicheres Passwort:

- Verwenden Sie mindestens 8 Zeichen (wir empfehlen 12+).
- Verwenden Sie Groß- und Kleinbuchstaben.
- Fügen Sie Zahlen und Sonderzeichen hinzu (!, @, # usw.).
- Vermeiden Sie gängige Wörter oder persönliche Informationen.

Wenn Sie das Standardpasswort nicht ändern, kann Ihr Gerät Sicherheitsrisiken ausgesetzt sein. Wenn Sie Hilfe benötigen, wenden Sie sich bitte an unseren Kundensupport.

Dashboard

The screenshot shows the Dashboard page with a navigation bar at the top containing: Dashboard (active), Network, Schedule, Protocols, Email, Clock, System, and Security. The main content area is divided into several sections:

- System Controls:** Includes buttons for ALL ON, ALL OFF, SYSTEM RESTART, and ALL METERS RESET.
- Summary Metrics:** Displays Total Current (9.9 A), Total Power (2400.0 W), Total Energy Consumed (999999.9 kWh), Voltage (240 V), Frequency (50 Hz), and Power Factor (0.8). A note indicates energy measured since 2023-5-1 12:34.
- Outlet Management:** Four outlets (OUTLET 1-4) are shown, each with a power icon, RS (Reset) button, and ON/OFF toggle. Each outlet displays Current (9.9 A) and Power (2400.0 W). Below each outlet is a Settings button.
- Outlet Settings (OUTLET 1):** A detailed settings panel for Outlet 1, including: Outlet Label (Outlet 1, <= 10 Chars), Outlet Re-Power Delay (seconds), Outlet Power-Off Delay (seconds), and Meters Reset Duration (seconds). A Save Changes button is at the bottom.

The footer contains: System Time: 2024-12-11 11:59, Uptime: 90days 12 hrs 59 mins, GUI Version: 1.0.0.1, System auto logout in 15mins, Maintenance, and Logout buttons.

- **ALL ON/ALL OFF:** Schaltet alle 4 Ausgänge ein/aus.
- **SYSTEM RESTART:** Neustart des Geräts.
- **ALL METERS RESET:** Setzt die Messwerte der 4 Ausgänge zurück.
- **OUTLET 1-2-3-4**
 - RS:** Zurücksetzen der verbrauchten Energie.
 - ON/OFF:** Einschalten/Ausschalten.
 - Settings:** Benennen Sie die Steckdose um, stellen Sie die Verzögerungen für das Wiedereinschalten und das Ausschalten ein und legen Sie die Dauer für das Zurücksetzen der Messwerte fest.
 - Save Changes:** Klicken Sie darauf um die Einstellungen der Steckdose zu speichern.

Network

The screenshot shows the Network configuration page with a navigation bar at the top containing: Dashboard, Network (active), Schedule, Protocols, Email, Clock, System, and Security. The main content area is divided into several sections:

- TCP/IP 1 Settings:** Includes Enable TCP/IP 1 (ON/OFF), Use IPv4 DHCP (Yes/Static IP), MAC Address (2A:3B:4C:5D:6E:7F), IPv4 Address (192.168.3.2), IPv4 Netmask (255.255.0.0), IPv4 Gateway (192.168.3.0), and IPv4 DNS (8.8.8.8). A Save Changes button is at the bottom.
- TCP/IP 2 Settings:** Includes Enable TCP/IP 2 (ON/OFF), Use IPv4 DHCP (Yes/Static IP), MAC Address (2A:3B:4C:5D:6E:7F), IPv4 Address (192.168.3.2), IPv4 Netmask (255.255.0.0), IPv4 Gateway (192.168.3.0), and IPv4 DNS (8.8.8.8). A Save Changes button is at the bottom.
- IPv6 Settings:** Includes Ethernet (TCP/IP 1/TCP/IP 2), Use IPv6 Protocol (Yes/No), Use IPv6 Router Advertisement (Yes/No), IPv6 Settings (DHCP v6/Manual), IPv6 Addresses (/64), IPv6 DNS Address 1, IPv6 DNS Address 2, IPv6 Gateway Address 1, and IPv6 Gateway Address 2. A Save Changes button is at the bottom.
- General Network Settings:** Includes Reply ICMP PING (Yes/No), HTTP Server (HTTP ONLY/HTTPS ONLY), HTTP Server Port (80), HTTPS Server Port (443), and TLS Versions (TLS 1.2 only). A Save Changes button is at the bottom.
- mDNS and Hostname:** Includes mDNS (Yes/No) and Hostname (80). A Save Changes button is at the bottom.

The footer contains: System Time: 2024-12-11 11:59, Uptime: 90days 12 hrs 59 mins, GUI Version: 1.0.0.1, System auto logout in 15mins, Maintenance, and Logout buttons.

Netzwerkeinstellungen, IPv4 und IPv6 für beide TCP/IP-Ports, PING ein/aus, HTTP-Server und mDNS.

Schedule

System Time: 2024-12-11 11:59 Uptime: 90days 12 hrs 59 mins GUI Version: 1.0.0.1 System auto logout in 15mins Maintenance Logout

Wählen Sie die Ausgänge aus und planen Sie den Ein-/Aus-Status nach Tagen und Stunden (grün ist an, rot ist aus).

Protocols

System Time: 2024-12-11 11:59 Uptime: 90days 12 hrs 59 mins GUI Version: 1.0.0.1 System auto logout in 15mins Maintenance Logout

Wählen Sie die verfügbaren Protokolle SNMP, Telnet, MQTT, SSH und Modbus TCP, um die gewünschte Verbindung herzustellen. In jedem Fenster wird die Konfiguration des gewählten Protokolls angezeigt.

Email

Dashboard	Network	Schedule	Protocols	Email	Clock	System	Security
-----------	---------	----------	-----------	-------	-------	--------	----------

SMTP Settings

SMTP Server:

SMTP Server Port:

Connection Encryption: (NONE, SSL/TLS, STARTTLS)

Enable SMTP Authentication: Yes No

Username:

Password:

Repeat Password:

Default Sender Name:

Send System Daily Reports: Yes No
Report send only when alarm happens if not tick Yes.

Daily Report Time: (hh:mm)

Email Testing

SMTP Setting must be completed before email testing.

To Recipients:

Separate by ',' to send multiple recipients, for example: user1@email.com,user2@email.com

From Sender:

Fill in custom email sender address, leave blank by using default address

Custom Email Content

Email Topic:

Using system default topic when custom topic is no set.

To Recipients:

Separate by ',' to send multiple recipients, for example: user1@email.com,user2@email.com

System Time: 2024-12-11 11:59
Uptime: 90days 12 hrs 59 mins
GUI Version: 1.0.0.1
System auto logout in 15mins

Richten Sie den E-Mail-Server und das Konto für den Empfang von Warnungen und Berichten ein.

Clock

Dashboard	Network	Schedule	Protocols	Email	Clock	System	Security
-----------	---------	----------	-----------	-------	-------	--------	----------

NTP Settings

Enable NTP Server: Yes No

Primary NTP Server:

Secondary NTP Server:

Timezone:

Daylight Saving Time (DST): Yes No

Clock Format: 12-hour 24-hour

Manual Settings

Set Date Manually: (yyyy-mm-dd)

Set Time Manually: (hh:mm)

Clock Format: 12-hour 24-hour

System Time: 2024-12-11 11:59
Uptime: 90days 12 hrs 59 mins
GUI Version: 1.0.0.1
System auto logout in 15mins

Konfigurieren Sie die Zeiteinstellungen manuell oder über eine Internetverbindung, indem Sie den NTP-Server aktivieren.

System

Systemeinstellungsseite, Entsperren der Tasten auf der Vorderseite, Login-Timeout, Warntonzeit, Überlastverarbeitung und Überstromschwellenwert.

Security

Sicherheitseinstellungen, Änderung des Login-Passworts und der Radius-Client-Parameter.

Maintenance

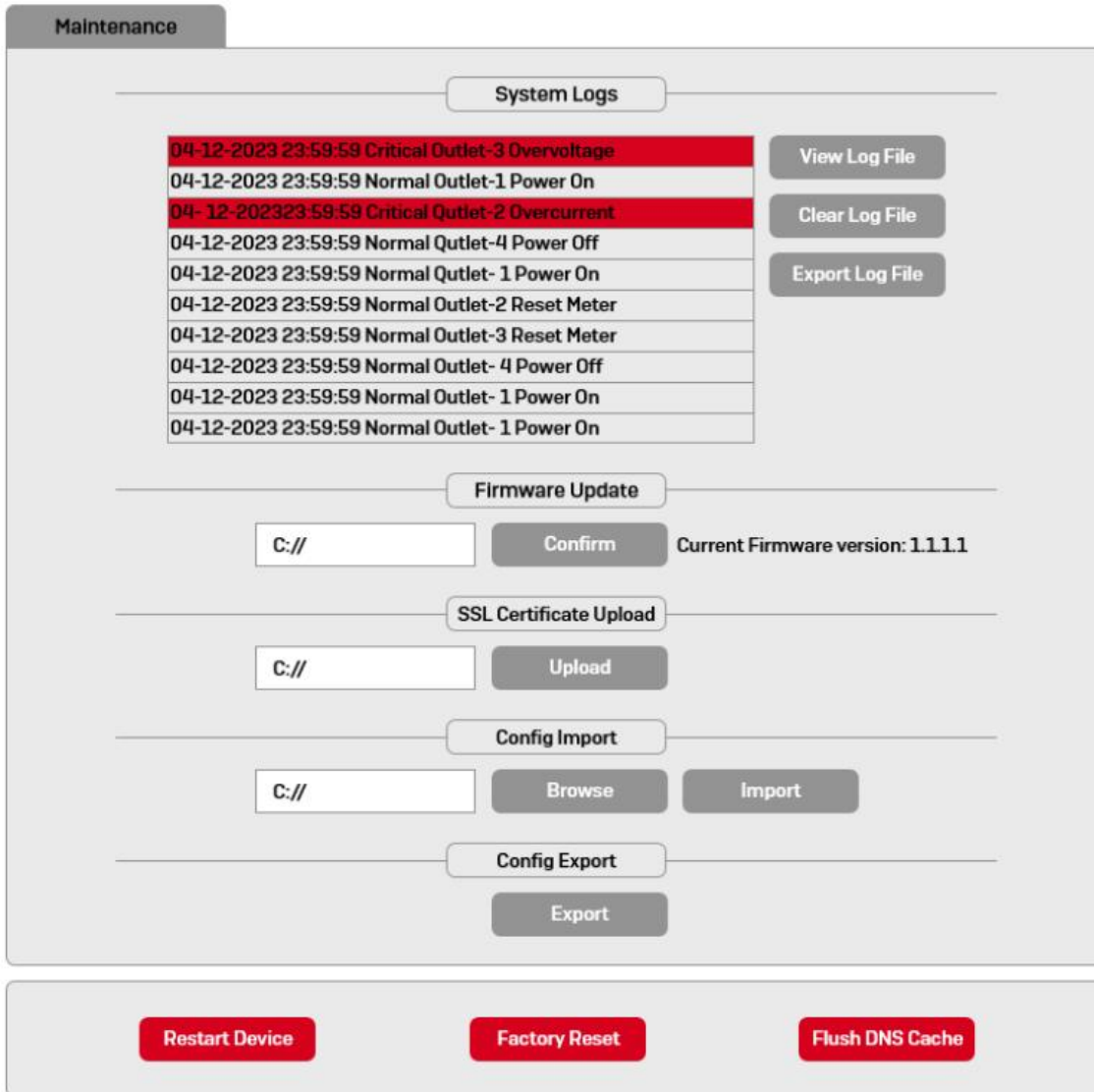

Klicken Sie auf die Schaltfläche „Maintenance“ um die Systemprotokolle anzuzeigen, die Firmware zu aktualisieren, das SSL-Zertifikat hochzuladen, die Konfiguration zu importieren und zu exportieren, das Gerät neu zu starten, auf die Werkseinstellungen zurückzusetzen und den DNS-Cache zu leeren.

Befehle

Anschluss 1 IP-Adresse: 192.168.0.178

Anschluss 2 IP-Adresse: 169.254.2.225

Telnet-Anschluss: 4001

Baudrate: 57600 (Standard)

Datenbit: 8

Stoppbit: 1

Prüfbit: keines

Abschlusszeichen: <CR><LF>

Error command feedback code: <Command Error <Out of Range

Command	Function	Example	Feedback
>?/Help	Listet alle Befehle auf	>? >Help	All the commands list
>GetStatus	Prüft den Status des Geräts.	>GetStatus	<Lindy-32622 <V1.0.0a <GetPowerStatus On <GetKeyStatus On <GetTCP/IPEnable 1

<GetRS232Baud 57600
<GetSystemCurrentThreshold
10.9A
<Outlet 1 Off
<Outlet 2 Off
<Outlet 3 Off
<Outlet 4 Off
<GetGroundStatus Properly
Grounded
<GetOutletMode 1 Idle
<GetOutletMode 2 Idle
<GetOutletMode 3 Idle
<GetOutletMode 4 Idle
<GetOutletPowerOnTime 1 1s
<GetOutletPowerOnTime 2 2s
<GetOutletPowerOnTime 3 3s
<GetOutletPowerOnTime 4 4s
<GetOutletPowerOffTime 1 1s
<GetOutletPowerOffTime 2 2s
<GetOutletPowerOffTime 3 3s
<GetOutletPowerOffTime 4 4s
<GetOutletEleResetTime 1
10s
<GetOutletEleResetTime 2
10s
<GetOutletEleResetTime 3
10s
<GetOutletEleResetTime 4
10s
<GetSafeMode
Outlet_Shutdown
<GetStandbyMode
All_Standby_Mode
<GetOverloadRetryCnt 1
<GetOverloadRetryTime
3mins
<GetBeeperTime 10s
<TCP/IP1 DHCP Off
<TCP/IP1 IP Address
169.254.000.178
<TCP/IP1 Gateway Address
<TCP/IP1 Subnet Mask
255.255.000.000
<MAC1 Address
CC:8C:DA:00:00:00
<TCP/IP2 DHCP Off
<TCP/IP2 IP Address
192.168.000.200
<TCP/IP2 Gateway Address
192.168.000.001
<TCP/IP2 Subnet Mask
255.255.255.000
<MAC2 Address
CC:8C:DA:00:00:00
<mDNS Off
<mDNS Name Lindy-32622
<TCP/IPv61 Protocol Off
<TCP/IPv61 DHCP Off
<TCP/IPv61 IP Address
<TCP/IPv61 Gateway
Address1

			<TCP/IPv61 Gateway Address2 <TCP/IPv62 Protocol Off <TCP/IPv62 DHCP Off <TCP/IPv62 IP Address <TCP/IPv62 Gateway Address1 <TCP/IPv62 Gateway Address2
>GETOUTLETSTATUS	Prüft den Status eines Anschlusses. >GETOUTLETSTATUS [Param1] [Param1] = 0-4	>GETOUTLETSTATUS 1	<Outlet 1 On
>GetElesta	Prüft die Stromdaten wie Leistungsaufnahme, Spannung, Stromstärke usw.	>GetElesta	<Lindy-32622 <V1.0.0a <Total Current 0.000A <Total Power 0.000W <Total Energy Consumed 0.000000kWh <Voltage 232.199V <Frequency 49.54Hz <Power Factor 0.00 <GetOutletVoltage 1 0.000V <GetOutletVoltage 2 0.000V <GetOutletVoltage 3 0.000V <GetOutletVoltage 4 0.000V <GetOutletCurrent 1 0.000A <GetOutletCurrent 2 0.000A <GetOutletCurrent 3 0.000A <GetOutletCurrent 4 0.000A <GetOutletPower 1 0.000W <GetOutletPower 2 0.000W <GetOutletPower 3 0.000W <GetOutletPower 4 0.000W <GetOutletConsumed 1 0.000000kWh <GetOutletConsumed 2 0.000000kWh <GetOutletConsumed 3 0.000000kWh <GetOutletConsumed 4 0.000000kWh <GetOutletPowerFactor 1 0.00 <GetOutletPowerFactor 2 0.00 <GetOutletPowerFactor 3 0.00 <GetOutletPowerFactor 4 0.00
>GetFwVersion	Prüft die Firmwareversion.	>GetFwVersion	<FW VersiOn: V1.0.0a <GUI VersiOn: V1.0.0a
>SetDeviceName	Einen Namen für das Gerät festlegen. >SetDeviceName: [Param1] [Param1] sollte der festzulegende Name sein. (max. 14 Zeichen)	>SetDeviceName: Lindy-32622	<Device Name: Lindy-32622
>SetPower	Standby-Modus aktivieren/deaktivieren. >SetPower [Param1] [Param1] = On,Off On - Einschalten Off - Ausschalten	>SetPower On >SetPower Off	<System Power Off <System Power On, Please Wait A Moment... Done
>SetKeyLock	Taste auf der Vorderseite sperren/entsperren. >SetKeyLock [Param1] [Param1] = On,Off	>SetKeyLock On >SetKeyLock Off	<KeyLock On <KeyLock Off

	On-GetKeyStatus Off Off- GetKeyStatus On		
>SetCurrentThreshold	Legt einen Stromschwellenwert für das System fest. >SetCurrentThreshold [Param1] [Param1] = 0.0-10.9	>SetCurrentThreshold 10	<System Current Threshold 10.0A
>SetVoltageThreshold	Legt einen Spannungsschwellenwert für das System fest. >SetVoltageThreshold [Param1] [Param1] =198-264	>SetVoltageThreshold 264	<System Voltage Threshold 264V
>SetSafeMode	Legt eine Aktion fest, die das System bei Überlastung durchführt. >SetSafeMode [Param1] [Param1] = 0-2 0: Abschalten des Ausgangs 1: Abschalten des Systems 2: Automatische Wiederholung	>SetSafeMode 0 >SetSafeMode 1 >SetSafeMode 2	<System Safe Mode: Outlet_Shutdown <System Safe Mode: System_Shutdown <System Safe Mode: Auto_Retry
>SetOverloadRetryCnt	Legt fest, wie oft das System neu gestartet wird wenn es überlastet ist >SetOverloadRetryCnt [Param1] [Param1] = 1-3 1 (Standard)	>SetOverloadRetryCnt 1 >SetOverloadRetryCnt 2 >SetOverloadRetryCnt 3	<System Retry Number 1 <System Retry Number 2 <System Retry Number 3
>SetOverloadRetryTime	Einstellen einer zeitlichen Verzögerung für einen Neustart des Systems bei Überlastung. (Einheit in Minuten) >SetOverloadRetryTime [Param1] [Param1] = 1-10 3 (Standard)	>SetOverloadRetryTime 1	<System Retry Delay Time 1mins
>SetStandbyMode	Einstellen eines Standby-Modus für das System. >StandbyMode [Param1] [Param1] = 0-1 0: All_Standby_Mode (GUI reagiert nicht) 1: Sleep_Mode (GUI reagiert, kein Datenaustausch mit MCU)	>SetStandbyMode 0 >SetStandbyMode 1	<System Standby Mode: All_Standby_Mode <System Standby Mode: Sleep_Mode
>SetRs232Baud	Stellt Baudrate für RS232 ein >SetRs232Baud [Param1] [Param1] = 1-7 1: 2400 2: 4800 3: 9600 4: 19200 5: 38400 6: 57600 (Standard) 7: 115200	>SetRs232Baud 6	<RS232Baud 57600
>SetRs232Out	RS232 Passthrough >SetRs232Out [Param1][Param2][Param3][Param4] [Param1] = a,h a: ASCII h: HEX [Param2] = 1-7 1: 2400 2: 4800 3: 9600 4: 19200 5: 38400 6: 57600 (Standard) 7: 115200	>SETRS232OUT a:6:1:RS232	RS232

	[Param3] = 1-3 1: None 2: Even 3: Odd Param4 = string		
>SetBeeperTime	Stellt Dauer des Signaltons ein. (Einheit in Sekunden) >SetBeeperTime [Param1] [Param1] = 0: 9999 10 (Standard)	>SetBeeperTime 10	<Buzzer Sound Time 10s
>SetOutletTime	Festlegen einer bestimmten Zeit für das Ein- und Ausschalten eines Anschlusses. (Einheit in Sekunden) >SetOutlet[Param1]Time [Param2][Param3] [Param1] = On,Off [Param2] = 1-4 1: Outlet1 2: Outlet2 3: Outlet3 4: Outlet4 [Param3] = 2-9999 (On)/ 0-9999 (Off)	>SetOutletOnTime 1:1 >SetOutletOffTime 1:1	<Outlet 1 Power_On Delay 1s <Outlet 1 Power_Off Delay 1s
>SetOutletEleResetTime	Legt die zeitliche Verzögerung für das Zurücksetzen der Werte eines bestimmten Ausgangs auf der GUI fest. >SetOutletEleResetTime[Param1][Param2] [Param1] = 1-4 1: Outlet1 2: Outlet2 3: Outlet3 4: Outlet4 [Param2] = 0-9999 10 (Standard)	>SetOutletEleResetTime 1:10	<Outlet 1 Electrical Work Reset Duration 10s
>SetAllOut	Alle Anschlüsse ein-/ausschalten. >SetAllOut [Param1] [Param1] = On,Off	>SetAllOut On >SetAllOut Off	<All Outlets On <All Outlets Off
>SetOutlet	Einen Anschluss ein-/ausschalten. >SetOutlet [Param1][Param2] [Param1] = 1-4 1: Outlet1 2: Outlet2 3: Outlet3 4: Outlet4 [Param2] = On,Off	>SetOutlet 1 On	<Outlet 1 On
>RsAllOutEle	Zurücksetzen der auf der GUI angezeigten Messwerte für alle Anschlüsse.	>RsAllOutEle	<Clean Up Electrical Work: All Outlets
>RsOutEle	Zurücksetzen der auf der GUI angezeigten Messwerte für einen Ausgang. >RsOutEle [Param1] [Param1] = 1-4 1: Outlet1 2: Outlet2 3: Outlet3 4: Outlet4	>RsOutEle 1	<Clean Up Electrical Work: Outlet 1
>GetSysTime	Abrufen des Datums und der Uhrzeit des Systems.	>GetSysTime	<GetSystemTime: 2023-05-11 02:47:16 Thu
>SetSysTime	Datum und Uhrzeit des Geräts einstellen:	>SetSysTime 2025-03-18;11-26-59	<SetSystemTime: 2025-03-18 11:26:59

	>SetSysTime [Param1] [Param1] = year-month-day;hour-minutes-seconds		
>SetNetTcp/IpEnable	TCP/IP aktivieren/deaktivieren: >SetNetTcp/IpEnable [Param1] [Param1] = 1-2 1: TCP/IP1 2: TCP/IP2	>SetNetTcp/IpEnable 1 >SetNetTcp/IpEnable 2	<TCP/IP1 Enable <TCP/IP2 Enable
>SetNetTcp/Ip1Dhcp	DHCP für TCP/IP1 ein-/ausschalten: >SetNetTcp/Ip1Dhcp [Param1] [Param1] = On,Off	>SetNetTcp/Ip1Dhcp On >SetNetTcp/Ip1Dhcp Off	<TCP/IP1 DHCP On <TCP/IP1 DHCP Off
>SetNetTcp/Ip1Ip	IP-Adresse für TCP/IP1 einstellen: >SetNetTcp/Ip1Ip [Param1] [Param1] = XXX.XXX.XXX.XXX	>SetNetTcp/Ip1Ip 192.168.000.001	<TCP/IP1 IP Address 192.168.000.001
>SetNetTcp/Ip1Gw	Gateway für TCP/IP1 einstellen: >SetNetTcp/Ip1Gw [Param1] [Param1] = XXX.XXX.XXX.XXX	>SetNetTcp/Ip1Gw 192.168.000.254	<TCP/IP1 Gateway Address 192.168.000.254
>SetNetTcp/Ip1Sm	Subnetzmaske für TCP/IP1 einstellen: >SetNetTcp/Ip1Sm [Param1] [Param1] = XXX.XXX.XXX.XXX	>SetNetTcp/Ip1Sm 192.168.000.254	<TCP/IP1 Subnet Mask 192.168.000.254
>SetNetTcp/Ip2Dhcp	DHCP von TCP/IP2 einstellen: >SetNetTcp/Ip2Dhcp [Param1] [Param1] = On,Off	>SetNetTcp/Ip2Dhcp On >SetNetTcp/Ip2Dhcp Off	<TCP/IP2 DHCP On <TCP/IP2 DHCP Off
>SetNetTcp/Ip2Ip	IP-Adresse für TCP/IP2 einstellen: >SetNetTcp/Ip2Ip [Param1] [Param1] = XXX.XXX.XXX.XXX	>SetNetTcp/Ip2Ip 192.168.000.001	<TCP/IP2 IP Address 192.168.000.001
>SetNetTcp/Ip2Gw	Gateway für TCP/IP2 einstellen: >SetNetTcp/Ip2Gw [Param1] [Param1] = XXX.XXX.XXX.XXX	>SetNetTcp/Ip2Gw 192.168.000.254	<TCP/IP2 Gateway Address 192.168.000.254
>SetNetTcp/Ip2Sm	Subnetzmaske für TCP/IP2 einstellen >SetNetTcp/Ip2Sm [Param1] [Param1]	>SetNetTcp/Ip2Sm 192.168.000.254	<TCP/IP2 Subnet Mask 192.168.000.254
>SetNetMdns	mDNS ein-/ausschalten >SetNetMdns [Param1] [Param1] = On,Off	>SetNetMdns On >SetNetMdns Off	<mDNS On <mDNS Off
>SetNetRb	IP-Service neu starten	>SetNetRb	<Network Reboot And Apply New Config
>SetNetTcp/Ipv61Protocol	TCP/IPv61 Protokoll ein-/ausschalten >SetNetTcp/Ipv61Protocol [Param1] [Param1] = On,Off	>SetNetTcp/Ipv61Protocol On >SetNetTcp/Ipv61Protocol Off	<TCP/IPv6 1 Protocol On <TCP/IPv6 1 Protocol Off
>SetNetTcp/Ipv61Dhcp	DHCP für TCP/IPv61 ein-/ausschalten >SetNetTcp/Ipv61Dhcp [Param1] [Param1] = On,Off	>SetNetTcp/Ipv61Dhcp On >SetNetTcp/Ipv61Dhcp Off	<TCP/IPv6 1 DHCP On <TCP/IPv6 1 DHCP Off
>SetNetTcp/Ipv61Ip	IP-Adresse für TCP/IPv61 einstellen >SetNetTcp/Ipv61Ip [Param1] [Param1] = XXX.XXX.XXX.XXX	>SetNetTcp/Ipv61Ip 192.168.000.001	<TCP/IPv6 1 IP Address 192.168.000.001
>SetNetTcp/Ipv61Gw	Gateway für TCP/IPv6 einstellen: >SetNetTcp/Ipv61Gw [Param1][Param2] [Param1] = 1-2 [Param2] = XXX.XXX.XXX.XXX	>SetNetTcp/Ipv61Gw 1 192.168.000.254 >SetNetTcp/Ipv61Gw 2 192.168.000.254	<TCP/IPv6 1 Gateway Address1 192.168.000.254 <TCP/IPv6 1 Gateway Address2 192.168.000.254
>SetNetTcp/Ipv62Protocol	TCP/IPv62 Protokoll ein-/ausschalten >SetNetTcp/Ipv62Protocol [Param1] [Param1] = On,Off	>SetNetTcp/Ipv62Protocol On >SetNetTcp/Ipv62Protocol Off	<TCP/IPv6 2 Protocol On <TCP/IPv6 2 Protocol Off

>SetNetTcp/Ipv62Dhcp	TCP/IPv62 DHCP ein-/ausschalten >SetNetTcp/Ipv62Dhcp [Param1] [Param1] = On,Off	>SetNetTcp/Ipv62Dhcp On >SetNetTcp/Ipv62Dhcp Off	<TCP/IPv6 2 DHCP On <TCP/IPv6 2 DHCP Off
>SetNetTcp/Ipv62Ip	IP-Adresse für TCP/IPv62 einstellen >SetNetTcp/Ipv62Ip [Param1] [Param1] = XXX.XXX.XXX.XXX	>SetNetTcp/Ipv62Ip 192.168.000.001	<TCP/IPv6 2 IP Address 192.168.000.001
>SetNetTcp/Ipv62Gw	Gateway für TCP/IPv62 einstellen: >SetNetTcp/Ipv62Gw [Param1][Param2] [Param1] = 1-2 [Param2] = XXX.XXX.XXX.XXX	>SetNetTcp/Ipv62Gw 1 192.168.000.254 >SetNetTcp/Ipv62Gw 2 192.168.000.254	<TCP/IPv6 2 Gateway Address1 192.168.000.254 <TCP/IPv6 2 Gateway Address2 192.168.000.254
>FactoryReset	Gerät auf die Werkseinstellungen zurücksetzen.	>FactoryReset	<FactoryReset
>Reboot	Neustart von MCU und GUI	>Reboot	<Reboot
>Resta	MCU neu starten	>Resta	<System Restart

Lindy überprüft und testet regelmäßig unsere Produktpalette, um maximale Kompatibilität und Leistung zu gewährleisten. Die aktuellste Version dieses Handbuchs finden Sie auf Ihrer lokalen Lindy-Website. Suchen Sie nach der entsprechenden Teilenummer und finden Sie das Handbuch unter Downloads.

Introduction

Nous sommes heureux que votre choix se soit porté sur un produit LINDY et vous remercions de votre confiance. Vous pouvez compter à tout moment sur la qualité de nos produits et de notre service. Ce commutateur IPower 4 ports est soumis à une durée de garantie LINDY de 3 année(s) et d'une assistance technique gratuite à vie. Merci de lire attentivement ces instructions et de les conserver pour future référence.

Ce commutateur IPower est conçu pour contrôler et surveiller l'alimentation via TCP/IP afin de permettre une gestion pratique de l'alimentation à distance. Les administrateurs système peuvent contrôler l'alimentation de plusieurs appareils, postes de travail, commutateurs, routeurs, etc. et activer ou désactiver l'alimentation tout en surveillant la consommation électrique via une interface graphique Web simple d'utilisation, des commandes RS-232 ou API.

Consignes de sécurité

! ATTENTION !

Merci de lire attentivement ces instructions de sécurité et de les conserver avec le produit.

Le non-respect de ces précautions peut causer un choc électrique entraînant des blessures graves, voire mortelles, un incendie ou des dommages au produit.

Cet appareil est équipé d'une alimentation à découpage et peut fonctionner avec des tensions d'alimentation de 100...250 VAC.

Toucher les composants internes ou un câble endommagé peut provoquer un choc électrique qui peut entraîner la mort.

Pour réduire les risques d'incendie, de choc électrique ou de dommages:

- Ne pas ouvrir le produit. Il ne contient pas d'éléments réparables.
- Seul un personnel d'entretien qualifié est autorisé à effectuer toute réparation ou entretien.
- Ne jamais utiliser de câble endommagé.
- Ne pas mouiller le produit et ne pas l'exposer à l'humidité.
- Ne pas utiliser ce produit à l'extérieur, il est réservé à un usage intérieur.
- Ne pas placer le produit à proximité de sources de chaleur. Toujours le placer dans un endroit suffisamment ventilé.
- Ne pas déposer de charge lourde sur le produit ou sur les câbles.

Veuillez vous assurer que tous les câbles sont solidement fixés et verrouillés en place avant de les insérer dans une prise de courant.

Informations sur la sécurité et la santé : Les produits LINDY sont conçus pour une utilisation sûre et efficace. Veuillez consulter ce guide pour obtenir des informations essentielles sur la sécurité et la santé, ainsi que des détails sur la garantie limitée de votre produit. Le respect de ces instructions d'installation, d'utilisation et d'entretien améliore le confort, la productivité et la sécurité. Le non-respect de ces instructions peut entraîner un choc électrique, un incendie, des blessures graves ou des dommages au produit ou à la propriété. Une assistance supplémentaire est disponible sur www.lindy.com.

Avertissement : Tenir hors de portée des enfants. Les produits et accessoires LINDY ne sont pas des jouets et ne doivent pas être manipulés par de jeunes enfants, car ils peuvent causer des blessures ou des dommages.

Risque de suffocation : Pour les produits contenant ou fournis dans des sacs en plastique, garder les sacs hors de portée des bébés et des enfants afin d'éviter tout risque de suffocation.

Sécurité de l'alimentation électrique : S'applique aux produits utilisant une alimentation en courant alternatif. Utilisez uniquement le bloc d'alimentation CA original ou compatible spécifié pour votre produit. Le non-respect de cette consigne peut entraîner un choc électrique, un incendie, des blessures graves ou des dommages au produit.

Utilisation correcte : Conservez l'appareil à l'abri de l'humidité, notamment de la pluie, de la neige ou de l'eau, et évitez de le placer à proximité de sources de chaleur, d'aliments, de saletés excessives, de poussière, d'huile, de produits chimiques ou de la lumière directe du soleil. Pour les appareils dotés de



ports, évitez d'y insérer des objets, de laisser la poussière s'accumuler ou d'utiliser des sources de chaleur telles qu'un sèche-cheveux ou un four à micro-ondes pour le sécher. Si l'appareil est mouillé, essuyez délicatement l'extérieur avec un chiffon sec.

Utilisation à haut risque : Ce produit n'est pas destiné à des applications dont la défaillance pourrait entraîner la mort, des blessures graves ou des dommages environnementaux importants (« utilisation à haut risque »). L'utilisation dans de telles applications se fait à vos risques et périls.

Atmosphères explosives : Ne stockez pas et ne transportez pas de matériaux inflammables ou explosifs à côté de ce produit ou de ses accessoires. Débranchez et éteignez toujours le produit, et évitez de le charger dans des zones où l'atmosphère est potentiellement explosive.

Connecteurs et ports de câbles : Pour éviter les chocs ou les incendies lors de l'utilisation de connecteurs avec une alimentation électrique, évitez tout contact pendant l'utilisation. Gardez les connecteurs à l'abri de l'humidité, de la saleté et des contaminants. Cessez d'utiliser l'appareil et contactez le service d'assistance si l'un des connecteurs semble endommagé.

Nettoyage : Pour minimiser les risques d'incendie, d'électrocution ou d'endommagement du produit, débranchez tous les câbles et mettez l'appareil et les accessoires hors tension avant de les nettoyer. Utilisez un chiffon sec pour nettoyer l'extérieur uniquement. Évitez d'insérer des objets dans les ports et ne plongez pas les connecteurs dans des liquides ; au contraire, essuyez-les et séchez-les soigneusement.

Risque lié aux réparations : Tenter d'ouvrir ou de réparer ce produit peut vous exposer à des risques d'électrocution, d'incendie ou de blessure. LINDY recommande fortement de faire appel à des services de réparation professionnels, car les réparations non autorisées peuvent annuler votre garantie.

ATTENTION

Irritation de la peau : Ce produit contient des matériaux couramment utilisés dans l'électronique qui peuvent provoquer une irritation de la peau chez certains utilisateurs. Pour réduire ce risque, nettoyez régulièrement votre appareil, évitez d'appliquer des lotions près des zones de contact et cessez d'utiliser l'appareil en cas d'irritation. Consultez votre fournisseur de soins de santé si les symptômes persistent.

Sécurité des câbles : Les câbles exposés peuvent faire trébucher. Disposez les câbles de manière à éviter les risques de trébuchement ou de traction et protégez-les contre les écrasements, les courbures brusques et l'exposition à la chaleur. Inspectez régulièrement les câbles et cessez de les utiliser s'ils sont endommagés. Débrancher les câbles en cas d'orage ou de stockage à long terme.

AVIS

Préoccupations liées à la chaleur : Le produit peut devenir chaud lors d'une utilisation régulière. Évitez tout contact prolongé avec la peau, assurez une ventilation adéquate et utilisez le produit dans des zones bien ventilées afin d'éviter toute surchauffe et tout inconfort.

Dispositifs médicaux personnels : Les émissions électroniques et les champs magnétiques des produits LINDY peuvent interférer involontairement avec des appareils médicaux, malgré la conformité réglementaire. Si vous suspectez une interférence, éteignez immédiatement le produit. Pour obtenir des conseils sur l'utilisation d'appareils électroniques à proximité, consultez le fabricant de votre appareil médical ou votre fournisseur de soins de santé.

Manipulation : Manipulez votre produit LINDY avec précaution. Le produit peut être endommagé en cas de chute, de perforation ou d'exposition à un liquide. Si vous pensez qu'il est endommagé, arrêtez de l'utiliser afin d'éviter tout risque potentiel.

Contenu

- Commutateur IPower à 4 ports
- Kit de montage avec supports
- Câble RS232 3 broches vers DB9 femelle, 1.35m
- Câbles Schuko et UK vers IEC C13, 1.8m
- 4 pieds en caoutchouc
- Manuel Lindy

Caractéristiques

- 4 ports de sortie IEC C13 10A pour les appareils
- Entrée d'alimentation IEC C14 10A
- Contrôle de l'alimentation, surveillance de la tension, du courant et de la consommation électrique

- Gestion via une interface graphique Web, RS-232, API et boutons du panneau avant
- Protocoles Telnet, Modbus TCP, SSH, SNMP et MQTT pris en charge
- 2 ports réseau RJ-45 redondants
- Protection contre les surcharges et les erreurs de câblage et vérification de la connexion à distance
- Prise en charge de nombreux protocoles de sécurité, réseau et IoT

Spécification

- Alimentation : 110-250V 50/60Hz 10A
- Consommation à vide : 1.53W
- Puissance commutée (totale) : max. 2500W (2640W 10A à 264V en réglant le seuil de tension)
- Voyants LED
- Plage de tension : 110~250V (90~264V en réglant le seuil de tension)
- Plage de courant : 0~10A
- Plage de fréquence : 45~65Hz
- Température de fonctionnement : -10~55°C (14°F~131°F)
- Température de stockage : -20~70°C (-4°F~158°F)
- Humidité relative : 0 à 95% (sans condensation)

Installation

Face avant

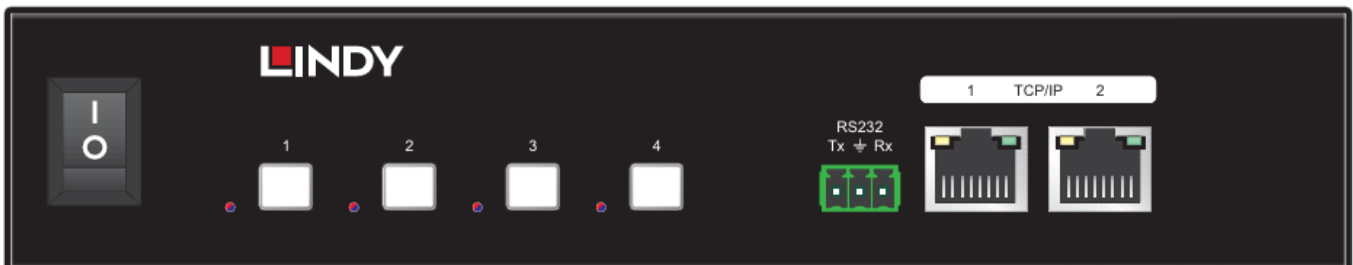

- POWER BUTTON: permet d'allumer/éteindre l'appareil.
- BUTTON 1-2-3-4: gestion manuelle de l'alimentation de chaque port de sortie.
État des voyants LED :
Bleu : alimentation activée
Bleu clignotant : initialisation du port avant la mise sous tension
Rouge : le port de sortie est en surcharge
Rouge clignotant : le port de sortie redémarre
- RS232: connexion à un PC, un contrôleur série ou un périphérique série via une connexion à 3 voies Phoenix Block pour la transmission en continu des commandes RS-232 et API.
- TCP/IP 1-2: deux ports RJ-45 redondants pour la connexion réseau afin d'accéder à l'interface graphique Web.

Arrière

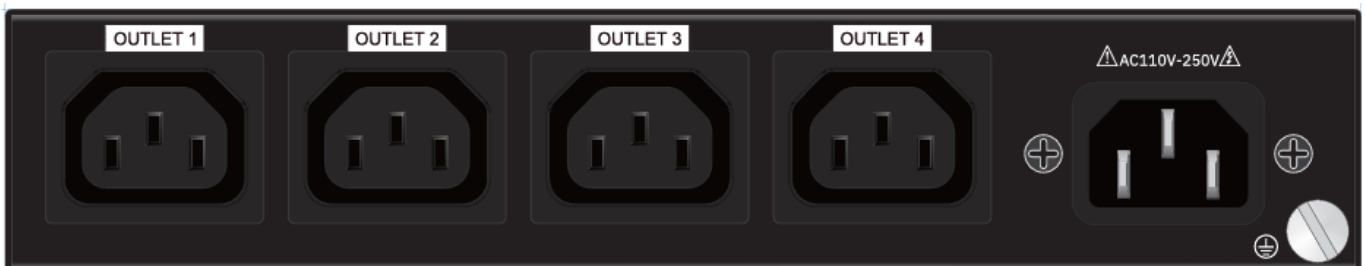

- OUTLET 1-2-3-4: ports IEC C13 pour alimenter les appareils connectés.
- AC 110V~250V: port d'entrée IEC C14 pour alimenter l'appareil.

Connectez tous les appareils aux ports OUTLET, puis allumez l'appareil et les appareils.

Utilisation

Web GUI

Connectez le port TCP/IP RJ-45 au réseau local ou connectez-le directement au port TCP/IP 1. Par défaut, l'appareil est réglé en mode DHCP. Pour obtenir automatiquement l'adresse IP attribuée dynamiquement, connectez l'appareil à un réseau compatible DHCP.

Il est également possible d'obtenir l'adresse IP actuelle en connectant l'appareil au port RS232 et en envoyant la commande >getstatus, comme indiqué dans la capture d'écran ci-dessous :

```
<TCP/IP1 DHCP On
<TCP/IP1 IP Address 192.168.000.178
<TCP/IP1 Gateway Address 169.254.002.001
<TCP/IP1 Subnet Mask 255.255.255.000
<MAC1 Address CC:8C:DA:36:79:91
<TCP/IP2 DHCP On
<TCP/IP2 IP Address 169.254.002.225
<TCP/IP2 Gateway Address 169.254.002.001
<TCP/IP2 Subnet Mask 255.255.000.000
<MAC2 Address CC:8C:DA:36:79:90
<mDNS On
<mDNS Name Lindy-32622
<TCP/IPv61 Protocol Off
<TCP/IPv61 DHCP Off
<TCP/IPv61 IP Address
<TCP/IPv61 Gateway Address1
<TCP/IPv61 Gateway Address2
<TCP/IPv62 Protocol Off
<TCP/IPv62 DHCP Off
<TCP/IPv62 IP Address
<TCP/IPv62 Gateway Address1
<TCP/IPv62 Gateway Address2
```

ClearData OpenFile SendFile Stop ClearSend OnTop English SaveConfig EXT

ComNum COM7 USB Serial Port HEXShow SaveData ReceivedToFile SendHEX SendEvery:800 ms/Tim AddCrLf

CloseCom More Settings Show Time and Packe OverTime:20 ms No 1 BytesTo 末尾 VerifyNone

RTS DTR BaudRat:57600 >GetStatus

S'il n'y a pas de serveur DHCP tel qu'un routeur dans le réseau, l'appareil reviendra aux paramètres IP par défaut suivants :

Port 1 : 192.168.0.178

Port 2 : 169.254.2.225

Masque de sous-réseau 1 : 255.255.255.0

Masque de sous-réseau 2 : 255.255.0.0

Passerelle : 192.168.0.1

Port Telnet : 4001

Saisissez l'adresse IP dans le navigateur pour ouvrir la page de connexion.

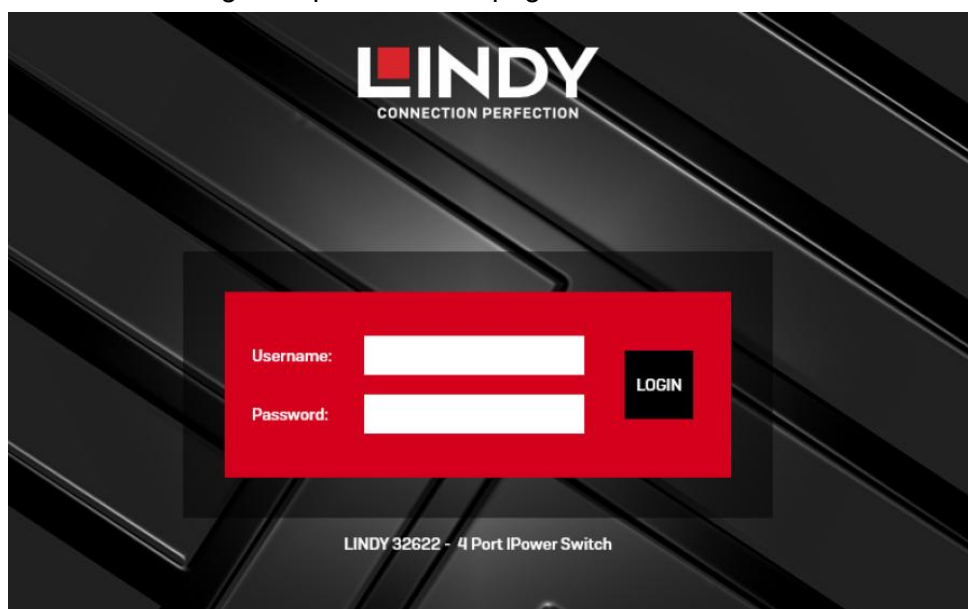

Nom d'utilisateur par défaut : admin

Mot de passe par défaut : aP?y43Tq

Saisissez le nom d'utilisateur et le mot de passe par défaut, puis cliquez sur **LOGIN**.

Important : modifiez immédiatement le mot de passe par défaut

Pour protéger votre produit et vos données personnelles, vous devez modifier le mot de passe par défaut dès que possible après la configuration.

Ce produit est conforme à la réglementation britannique sur la sécurité des produits et les infrastructures de télécommunications (PSTI), qui exige que tous les mots de passe par défaut soient uniques ou générés pour chaque appareil. Toutefois, afin de garantir un niveau de sécurité optimal, il est essentiel que vous définissiez votre propre mot de passe, fort et facile à mémoriser.

Comment modifier votre mot de passe :

1. Allumez l'appareil et connectez-vous à celui-ci à l'aide de l'interface Web.
2. Connectez-vous à l'aide des identifiants par défaut indiqués ci-dessus.
3. Accédez à **Security > Web-GUI login pass**.
4. Saisissez votre mot de passe actuel, puis saisissez votre nouveau mot de passe pour le confirmer.
5. Enregistrez vos modifications et reconnectez-vous à l'aide du nouveau mot de passe.

Conseils pour créer un mot de passe fort :

- Utilisez au moins 8 caractères (nous recommandons 12+)
- Incluez des lettres majuscules et minuscules
- Ajoutez des chiffres et des caractères spéciaux (!, @, #, etc.)
- Évitez les mots courants ou les informations personnelles

Si vous ne modifiez pas le mot de passe par défaut, votre appareil pourrait être exposé à des risques de sécurité. Si vous avez besoin d'aide, veuillez contacter notre service clientèle.

Dashboard

The dashboard interface includes the following elements:

- Navigation Tabs:** Dashboard (active), Network, Schedule, Protocols, Email, Clock, System, Security.
- System Controls:** ALL ON, ALL OFF, SYSTEM RESTART, ALL METERS RESET.
- Summary Metrics:**
 - Total Current: 9.9 A, Total Power: 2400.0 W
 - Total Energy Consumed: 999999.9 kWh
 - Voltage: 240 V
 - Frequency: 50 Hz, Power Factor: 0.8
- Outlet Management (OUTLET 1-4):**
 - Each outlet has an RS (Reset) button and an ON/OFF toggle.
 - Current and Power for each outlet: 9.9 A, 2400.0 W.
 - Energy Consumed for each outlet: 999999.9 kWh.
 - Voltage: 240V, PF: 0.75.
 - Settings button for each outlet.
- Settings Panel (OUTLET 1):**
 - Outlet Label: Outlet 1 (<= 10 Chars)
 - Outlet Re-Power Delay: [] seconds
 - Outlet Power-Off Delay: [] seconds
 - Meters Reset Duration: [] seconds
 - Save Changes button.
- Footer:**
 - System Time: 2024-12-11 11:59
 - Uptime: 90days 12 hrs 59 mins
 - GUI Version: 1.0.0.1
 - System auto logout in 15mins
 - Maintenance button
 - Logout button

- **ALL ON/ALL OFF:** allume/éteint les 4 prises.
- **SYSTEM RESTART:** redémarre l'appareil.
- **ALL METERS RESET:** réinitialise les compteurs des 4 prises.
- **OUTLET 1-2-3-4**
RS: réinitialise l'énergie consommée.
ON/OFF: allume/éteint.
Settings: renomme la prise, définit les délais de remise sous tension et de mise hors tension et

définit la durée de réinitialisation des compteurs.

Save Changes: cliquez pour enregistrer les paramètres de la prise.

Network

Dashboard Network Schedule Protocols Email Clock System Security

TCP/IP 1 Settings
Enable TCP/IP 1 ON OFF
Use IPv4 DHCP Yes Use Static IP
MAC Address: 2A:3B:4C:5D:6E:7F
IPv4 Address: 192.168.3.2
IPv4 Netmask: 255.255.0.0
IPv4 Gateway: 192.168.3.0
IPv4 DNS: 8.8.8.8
Save Changes

TCP/IP 2 Settings
Enable TCP/IP 2 ON OFF
Use IPv4 DHCP Yes Use Static IP
MAC Address: 2A:3B:4C:5D:6E:7F
IPv4 Address: 192.168.3.2
IPv4 Netmask: 255.255.0.0
IPv4 Gateway: 192.168.3.0
IPv4 DNS: 8.8.8.8
Save Changes

IPv6 Settings
Ethernet TCP/IP 1 TCP/IP 2
Use IPv6 Protocol Yes No
Use IPv6 Router Advertisement Yes No
IPv6 Settings DHCP v6 Manual
IPv6 Addresses: _____ /64
IPv6 DNS Address 1: _____
IPv6 DNS Address 2: _____
IPv6 Gateway Address 1: _____
IPv6 Gateway Address 2: _____
Save Changes

Reply ICMP PING Yes No
HTTP Server HTTP ONLY HTTPS ONLY
HTTP Server Port: 80
HTTPS Server Port: 443
TLS Versions: TLS 1.2 only
Save Changes

mDNS Yes No
Hostname: 80
Save Changes

System Time: 2024-12-11 11:59 Uptime: 90days 12 hrs 59 mins GUI Version: 1.0.0.1 System auto logout in 15mins Maintenance Logout

Paramètres réseau, IPv4 et IPv6 pour les deux ports TCP/IP, PING activé/désactivé, serveur HTTP et mDNS.

Schedule

Dashboard Network Schedule Protocols Email Clock System Security

Schedule Settings
Schedule Timer for: ALL OUTLETS
Turn ON All Time Turn OFF All Time

ALL OUTLETS
OUTLET 1
OUTLET 2
OUTLET 3
OUTLET 4

Turn ON All Time Turn OFF All Time

Please click below numbers to set the whole column to 'ON' or 'OFF'

Date/Hour	0	1	2	3	4	5	6	7	8	9	10	11	12	13	14	15	16	17	18	19	20	21	22	23
MON ▶		Red	Green	Green	Green	Green	Green	Green	Green	Green	Green	Green	Green	Green	Green	Green	Green	Green	Green	Green	Green	Green	Green	Green
TUE ▶		Green	Green	Green	Green	Green	Green	Green	Green	Green	Green	Green	Green	Green	Green	Green	Green	Green	Green	Green	Green	Green	Green	Green
WED ▶		Green	Green	Green	Green	Green	Green	Green	Green	Green	Green	Green	Green	Green	Green	Green	Green	Green	Green	Green	Green	Green	Green	Green
THU ▶		Green	Green	Green	Green	Green	Green	Green	Green	Green	Red	Green	Green	Green	Green	Green	Green	Green	Green	Green	Green	Green	Green	Green
FRI ▶		Green	Green	Green	Green	Green	Green	Green	Green	Green	Green	Green	Green	Green	Green	Green	Green	Green	Green	Green	Green	Green	Green	Green
SAT ▶		Green	Green	Green	Green	Green	Green	Green	Green	Green	Green	Green	Green	Green	Green	Green	Green	Green	Green	Green	Green	Green	Green	Green
SUN ▶		Green	Green	Green	Green	Green	Green	Green	Green	Green	Green	Green	Green	Green	Green	Green	Green	Green	Green	Green	Green	Green	Green	Green

Please click above week days to set the whole row to 'ON' or 'OFF'.
Please click above little squares to set schedule individually, once save changes, new schedule will be activated from next planning hour or after system reboot.

Green box: Power ON
Red box: Power OFF

Save Changes

System Time: 2024-12-11 11:59 Uptime: 90days 12 hrs 59 mins GUI Version: 1.0.0.1 System auto logout in 15mins Maintenance Logout

Sélectionnez les prises et programmez leur état marche/arrêt par jour et par heure (vert = marche, rouge = arrêt).

Protocols

Dashboard	Network	Schedule	Protocols	Email	Clock	System	Security
-----------	---------	----------	------------------	-------	-------	--------	----------

SNMP | Telnet | MQTT | SSH | Modbus TCP

Enable SNMP V1 Options SNMP GET SNMP SET

SNMP UDP Port

sysContact

sysName

sysLocation

Enable SNMP V2C Yes No

Enable SNMP V3 Yes No

Enable SNMP Trap V1 Trap V2C Trap V3 Trap
 Disable SNMP Trap

SNMP Trap Receiver 1

SNMP Trap Receiver 2

System Time: 2024-12-11 11:59 Uptime: 90days 12 hrs 59 mins GUI Version: 1.0.0.1 System auto logout in 15mins

Sélectionnez les protocoles disponibles parmi SNMP, Telnet, MQTT, SSH et Modbus TCP pour établir la connexion requise. Chaque fenêtre permet de configurer le protocole sélectionné.

Email

Dashboard	Network	Schedule	Protocols	Email	Clock	System	Security
-----------	---------	----------	-----------	--------------	-------	--------	----------

SMTP Settings

SMTP Server

SMTP Server Port

Connection Encryption NONE, SSL/TLS, STARTTLS

Enable SMTP Authentication Yes No

Username

Password

Repeat Password

Default Sender Name

Send System Daily Reports Yes No
Report send only when alarm happens if not tick Yes.

Daily Report Time (hh:mm)

Email Testing

SMTP Setting must be completed before email testing.

To Recipients

Seperate by ',' to send multiple recipients, for example: user1@email.com,user2@email.com

From Sender

Fill in custom email sender address, leave blank by using default address

Custom Email Content

Email Topic

Using system default topic when custom topic is no set.

To Recipients

Seperate by ',' to send multiple recipients, for example: user1@email.com,user2@email.com

System Time: 2024-12-11 11:59 Uptime: 90days 12 hrs 59 mins GUI Version: 1.0.0.1 System auto logout in 15mins

Configurez le serveur et le compte e-mail pour recevoir les alertes et les rapports.

Clock

Dashboard	Network	Schedule	Protocols	Email	Clock	System	Security
-----------	---------	----------	-----------	-------	-------	--------	----------

NTP Settings

Enable NTP Server Yes No

Primary NTP Server

Secondary NTP Server

Timezone

Daylight Saving Time (DST) Yes No

Clock Format 12-hour 24-hour

[Save Changes](#)

Manual Settings

Set Date Manually (yyyy-mm-dd)

Set Time Manually (hh:mm)

Clock Format 12-hour 24-hour

[Save Changes](#)

System Time: 2024-12-11 11:59
Uptime: 90days 12 hrs 59 mins
GUI Version: 1.0.0.1
System auto logout in 15mins
Maintenance
Logout

Configurez les paramètres de l'horloge manuellement ou via une connexion Internet en activant le serveur NTP.

System

Dashboard	Network	Schedule	Protocols	Email	Clock	System	Security
-----------	---------	----------	-----------	-------	-------	--------	----------

System Settings

Front Panel Lock Yes No

Device Name

Login Timeout min (Default: 15mins)

Warning Beeper Time s (Default: 10s)

Standby Mode Standby Mode Sleep Mode

[Save Changes](#)

Overload Processing Power off the overloaded outlet

Power off all outlets, then system standby

Auto recover retries, in mins [1-10, Default 3]

Overcurrent Threshold A (Max: 10.9A)

[Save Changes](#)

System Time: 2024-12-11 11:59
Uptime: 90days 12 hrs 59 mins
GUI Version: 1.0.0.1
System auto logout in 15mins
Maintenance
Logout

Page des paramètres système, déverrouillage des boutons du panneau avant, délai d'expiration de la connexion, durée du signal sonore d'avertissement, traitement des surcharges et seuil de surintensité.

Security

Navigation menu: Dashboard, Network, Schedule, Protocols, Email, Clock, System, Security

Security Settings

Web-GUI Login

Password: Web-GUI login pass

RADIUS

Enable Radius Client: Yes No

Authentication Protocol: PAP CHAP

Use Message Authentication: Yes No

Default Session Timeout: 1800 seconds

Primary Server:

New Shared Password:

Repeat Password:

Timeout: 5

Retries: 3

System Time: 2024-12-11 11:59 | Uptime: 90days 12 hrs 59 mins | GUI Version: 1.0.0.1 | System auto logout in 15mins |

Paramètres de sécurité, modification du mot de passe de connexion et des paramètres du client Radius.

Maintenance

Maintenance

System Logs

04-12-2023 23:59:59 Critical Outlet-3 Overvoltage	<input type="button" value="View Log File"/> <input type="button" value="Clear Log File"/> <input type="button" value="Export Log File"/>
04-12-2023 23:59:59 Normal Outlet-1 Power On	
04-12-2023 23:59:59 Critical Outlet-2 Overcurrent	
04-12-2023 23:59:59 Normal Outlet-4 Power Off	
04-12-2023 23:59:59 Normal Outlet- 1 Power On	
04-12-2023 23:59:59 Normal Outlet-2 Reset Meter	
04-12-2023 23:59:59 Normal Outlet-3 Reset Meter	
04-12-2023 23:59:59 Normal Outlet- 4 Power Off	
04-12-2023 23:59:59 Normal Outlet- 1 Power On	
04-12-2023 23:59:59 Normal Outlet- 1 Power On	

Firmware Update

C:// Current Firmware version: 1.1.1.1

SSL Certificate Upload

C://

Config Import

C://

Config Export

Cliquez sur le bouton Maintenance pour afficher les journaux système, mettre à jour le micrologiciel, télécharger le certificat SSL, importer et exporter la configuration, redémarrer l'appareil, réinitialiser les paramètres d'usine et vider le cache DNS.

Commandes

Adresse IP du port 1 : 192.168.0.178

Adresse IP du port 2 : 169.254.2.225

Port Telnet : 4001

Débit en bauds : 57600 (par défaut)

Bits de données : 8

Bit d'arrêt : 1

Bit de contrôle : aucun

Terminateur : <CR><LF>

Code de retour de commande d'erreur : <Command Error <Out of Range

Command	Function	Example	Feedback
>?/Help	Liste toutes les commandes	>? >Help	All the commands list
>GetStatus	Etat de l'appareil.	>GetStatus	<Lindy-32622 <V1.0.0a <GetPowerStatus On <GetKeyStatus On <GetTCP/IPEnable 1 <GetRS232Baud 57600 <GetSystemCurrentThreshold 10.9A <Outlet 1 Off <Outlet 2 Off <Outlet 3 Off <Outlet 4 Off <GetGroundStatus Properly Grounded <GetOutletMode 1 Idle <GetOutletMode 2 Idle <GetOutletMode 3 Idle <GetOutletMode 4 Idle <GetOutletPowerOnTime 1 1s <GetOutletPowerOnTime 2 2s <GetOutletPowerOnTime 3 3s <GetOutletPowerOnTime 4 4s <GetOutletPowerOffTime 1 1s <GetOutletPowerOffTime 2 2s <GetOutletPowerOffTime 3 3s <GetOutletPowerOffTime 4 4s <GetOutletEleResetTime 1 10s <GetOutletEleResetTime 2 10s <GetOutletEleResetTime 3 10s <GetOutletEleResetTime 4 10s <GetSafeMode Outlet_Shutdown <GetStandbyMode All_Standby_Mode <GetOverloadRetryCnt 1 <GetOverloadRetryTime 3mins

			<p><GetBeeperTime 10s <TCP/IP1 DHCP Off <TCP/IP1 IP Address 169.254.000.178 <TCP/IP1 Gateway Address <TCP/IP1 Subnet Mask 255.255.000.000 <MAC1 Address CC:8C:DA:00:00:00 <TCP/IP2 DHCP Off <TCP/IP2 IP Address 192.168.000.200 <TCP/IP2 Gateway Address 192.168.000.001 <TCP/IP2 Subnet Mask 255.255.255.000 <MAC2 Address CC:8C:DA:00:00:00 <mDNS Off <mDNS Name Lindy-32622 <TCP/IPv61 Protocol Off <TCP/IPv61 DHCP Off <TCP/IPv61 IP Address <TCP/IPv61 Gateway Address1 <TCP/IPv61 Gateway Address2 <TCP/IPv62 Protocol Off <TCP/IPv62 DHCP Off <TCP/IPv62 IP Address <TCP/IPv62 Gateway Address1 <TCP/IPv62 Gateway Address2</p>
>GETOUTLETSTATUS	Etat d'une sortie. >GETOUTLETSTATUS [Param1] [Param1] = 0-4	>GETOUTLETSTATUS 1	<Outlet 1 On
>GetElesta	Vérifiez les informations électriques, telles que la consommation d'énergie, la tension, le courant, etc.	>GetElesta	<p>< Lindy-32622 <V1.0.0a <Total Current 0.000A <Total Power 0.000W <Total Energy Consumed 0.000000kWh <Voltage 232.199V <Frequency 49.54Hz <Power Factor 0.00 <GetOutletVoltage 1 0.000V <GetOutletVoltage 2 0.000V <GetOutletVoltage 3 0.000V <GetOutletVoltage 4 0.000V <GetOutletCurrent 1 0.000A <GetOutletCurrent 2 0.000A <GetOutletCurrent 3 0.000A <GetOutletCurrent 4 0.000A <GetOutletPower 1 0.000W <GetOutletPower 2 0.000W <GetOutletPower 3 0.000W <GetOutletPower 4 0.000W <GetOutletConsumed 1 0.000000kWh <GetOutletConsumed 2</p>

			0.000000kWh <GetOutletConsumed 3 0.000000kWh <GetOutletConsumed 4 0.000000kWh <GetOutletPowerFactor 1 0.00 <GetOutletPowerFactor 2 0.00 <GetOutletPowerFactor 3 0.00 <GetOutletPowerFactor 4 0.00
>GetFwVersion	Version du firmware.	>GetFwVersion	<FW VersiOn: V1.0.0a <GUI VersiOn: V1.0.0a
>SetDeviceName	Nom de l'appareil. >SetDeviceName: [Param1] [Param1] should be the nickname you want to set. (14 characters maximum)	>SetDeviceName: Lindy-32622	<Device Name: Lindy-32622
>SetPower	Entrer/Sortir du mode standby. >SetPower [Param1] [Param1] = On,Off On - Power on Off - Power off	>SetPower On >SetPower Off	<System Power Off <System Power On, Please Wait A Moment... Done
>SetKeyLock	Verr./Deverr. les boutons en façade. >SetKeyLock [Param1] [Param1] = On,Off On-GetKeyStatus Off Off- GetKeyStatus On	>SetKeyLock On >SetKeyLock Off	<KeyLock On <KeyLock Off
>SetCurrentThreshold	Définissez un seuil de courant pour le système. >SetCurrentThreshold [Param1] [Param1] = 0.0-10.9	>SetCurrentThreshold 10	<System Current Threshold 10.0A
>SetVoltageThreshold	Définissez un seuil de tension pour le système. >SetVoltageThreshold [Param1] [Param1] =198-264	>SetVoltageThreshold 264	<System Voltage Threshold 264V
>SetSafeMode	Définissez une action que le système exécutera en cas de surcharge. >SetSafeMode [Param1] [Param1] = 0-2 0: Outlet_Shutdown 1: System_Shutdown 2:Auto_Retry	>SetSafeMode 0 >SetSafeMode 1 >SetSafeMode 2	<System Safe Mode: Outlet_Shutdown <System Safe Mode: System_Shutdown <System Safe Mode: Auto_Retry
>SetOverloadRetryCnt	Définissez combien de fois le système redémarrera en cas de surcharge. >SetOverloadRetryCnt [Param1] [Param1] = 1-3 1(Default)	>SetOverloadRetryCnt 1 >SetOverloadRetryCnt 2 >SetOverloadRetryCnt 3	<System Retry Number 1 <System Retry Number 2 <System Retry Number 3
>SetOverloadRetryTime	Définissez un délai avant le redémarrage du système en cas de surcharge. (en minutes) >SetOverloadRetryTime [Param1] [Param1] = 1-10 3(Default)	>SetOverloadRetryTime 1	<System Retry Delay Time 1mins
>SetStandbyMode	Définissez un mode veille pour le système. >StandbyMode [Param1] [Param1] = 0-1 0: All_Standby_Mode (GUI is not responsive)	>SetStandbyMode 0 >SetStandbyMode 1	<System Standby Mode: All_Standby_Mode <System Standby Mode: Sleep_Mode

	1: Sleep_Mode (GUI is responsive, no data exchange with MCU)		
>SetRs232Baud	Baudrate pour le RS232 >SetRs232Baud [Param1] [Param1] = 1-7 1: 2400 2: 4800 3: 9600 4: 19200 5: 38400 6: 57600(Default), 7: 115200	>SetRs232Baud 6	<RS232Baud 57600
>SetRs232Out	RS232 Passthrough >SetRs232Out [Param1][Param2][Param3][Param4]] [Param1] = a,h a: ASCII h: HEX [Param2] = 1-7 1: 2400 2: 4800 3: 9600 4: 19200 5: 38400 6: 57600(Default), 7: 115200 [Param3] = 1-3 1: None 2: Even 3: Odd Param4 = string	>SETRS232OUT a:6:1:RS232	RS232
>SetBeeperTime	Définir la durée du buzzer. (en secondes) >SetBeeperTime [Param1] [Param1] = 0: 9999 10(Default)	>SetBeeperTime 10	<Buzzer Sound Time 10s
>SetOutletTime	Délai pour l'activation ou la désactivation d'une prise. (en secondes) >SetOutlet[Param1]Time [Param2][Param3] [Param1] = On,Off [Param2] = 1-4 1: Outlet1 2: Outlet2 3: Outlet3 4: Outlet4 [Param3] = 2-9999 (On)/ 0-9999 (Off)	>SetOutletOnTime 1:1 >SetOutletOffTime 1:1	<Outlet 1 Power_On Delay 1s <Outlet 1 Power_Off Delay 1s
>SetOutletEleResetTime	Délai pour réinitialiser les valeurs d'une prise spécifique dans l'interface graphique (GUI). >SetOutletEleResetTime[Param1][Param2] [Param1] = 1-4 1: Outlet1 2: Outlet2 3: Outlet3 4: Outlet4	>SetOutletEleResetTime 1:10	<Outlet 1 Electrical Work Reset Duration 10s

	[Param2] = 0-9999 10(Default)		
>SetAllOut	Allumer/Eteindre toutes les prises. >SetAllOut [Param1] [Param1] = On,Off	>SetAllOut On >SetAllOut Off	<All Outlets On <All Outlets Off
>SetOutlet	Allumer/Eteindre une prise. >SetOutlet [Param1][Param2] [Param1] = 1-4 1: Outlet1 2: Outlet2 3: Outlet3 4: Outlet4 [Param2] = On,Off	>SetOutlet 1 On	<Outlet 1 On
>RsAllOutEle	Réinitialisez les valeurs mesurées affichées dans l'interface graphique (GUI) pour toutes les prises.	>RsAllOutEle	<Clean Up Electrical Work: All Outlets
>RsOutEle	Réinitialisez les valeurs mesurées affichées dans l'interface graphique (GUI) pour une prise spécifique. >RsOutEle [Param1] [Param1] = 1-4 1: Outlet1 2: Outlet2 3: Outlet3 4: Outlet4	>RsOutEle 1	<Clean Up Electrical Work: Outlet 1
>GetSysTime	Obtenez la date et l'heure du système.	>GetSysTime	<GetSystemTime: 2023-05-11 02:47:16 Thu
>SetSysTime	Réglez la date et l'heure de l'appareil: >SetSysTime [Param1] [Param1] = year-month-day;hour-minutes-seconds	>SetSysTime 2025-03-18;11-26-59	<SetSystemTime: 2025-03-18 11:26:59
>SetNetTcp/IpEnable	Activer/Désactiver TCP/IP: >SetNetTcp/IpEnable [Param1] [Param1] = 1-2 1: TCP/IP1 2: TCP/IP2	>SetNetTcp/IpEnable 1 >SetNetTcp/IpEnable 2	<TCP/IP1 Enable <TCP/IP2 Enable
>SetNetTcp/Ip1Dhcp	Activer/Désactiver DHCP pour TCP/IP1: >SetNetTcp/Ip1Dhcp [Param1] [Param1] = On,Off	>SetNetTcp/Ip1Dhcp On >SetNetTcp/Ip1Dhcp Off	<TCP/IP1 DHCP On <TCP/IP1 DHCP Off
>SetNetTcp/Ip1Ip	Définir une adresse IP pour TCP/IP1: >SetNetTcp/Ip1Ip [Param1] [Param1] = XXX.XXX.XXX.XXX	>SetNetTcp/Ip1Ip 192.168.000.001	<TCP/IP1 IP Address 192.168.000.001
>SetNetTcp/Ip1Gw	Définir une passerelle pour TCP/IP1: >SetNetTcp/Ip1Gw [Param1] [Param1] = XXX.XXX.XXX.XXX	>SetNetTcp/Ip1Gw 192.168.000.254	<TCP/IP1 Gateway Address 192.168.000.254
>SetNetTcp/Ip1Sm	Définir un masque de sous réseau pour TCP/IP1: >SetNetTcp/Ip1Sm [Param1] [Param1] = XXX.XXX.XXX.XXX	>SetNetTcp/Ip1Sm 192.168.000.254	<TCP/IP1 Subnet Mask 192.168.000.254
>SetNetTcp/Ip2Dhcp	Activer/Désactiver DHCP pour TCP/IP2: >SetNetTcp/Ip2Dhcp [Param1] [Param1] = On,Off	>SetNetTcp/Ip2Dhcp On >SetNetTcp/Ip2Dhcp Off	<TCP/IP2 DHCP On <TCP/IP2 DHCP Off
>SetNetTcp/Ip2Ip	Définir une adresse IP pour TCP/IP2: >SetNetTcp/Ip2Ip [Param1] [Param1] = XXX.XXX.XXX.XXX	>SetNetTcp/Ip2Ip 192.168.000.001	<TCP/IP2 IP Address 192.168.000.001

>SetNetTcp/Ip2Gw	Définir la passerelle pour TCP/IP2: >SetNetTcp/Ip2Gw [Param1] [Param1] = XXX.XXX.XXX.XXX	>SetNetTcp/Ip2Gw 192.168.000.254	<TCP/IP2 Gateway Address 192.168.000.254
>SetNetTcp/Ip2Sm	Définir le masque de sous réseau pour TCP/IP2 >SetNetTcp/Ip2Sm [Param1] [Param1]	>SetNetTcp/Ip2Sm 192.168.000.254	<TCP/IP2 Subnet Mask 192.168.000.254
>SetNetMdns	Activer/définir mDNS >SetNetMdns [Param1] [Param1] = On,Off	>SetNetMdns On >SetNetMdns Off	<mDNS On <mDNS Off
>SetNetRb	Reboot du service IP	>SetNetRb	<Network Reboot And Apply New Config
>SetNetTcp/Ipv61Protocol	Activer/Désactiver le protocole TCP/IPV6 >SetNetTcp/Ipv61Protocol [Param1] [Param1] = On,Off	>SetNetTcp/Ipv61Protocol On >SetNetTcp/Ipv61Protocol Off	<TCP/IPV6 1 Protocol On <TCP/IPV6 1 Protocol Off
>SetNetTcp/Ipv61Dhcp	Activer/Désactiver DHCP pour TCP/IPV6 >SetNetTcp/Ipv61Dhcp [Param1] [Param1] = On,Off	>SetNetTcp/Ipv61Dhcp On >SetNetTcp/Ipv61Dhcp Off	<TCP/IPV6 1 DHCP On <TCP/IPV6 1 DHCP Off
>SetNetTcp/Ipv61Ip	Définir une adresse IP pour TCP/IPV6 >SetNetTcp/Ipv61Ip [Param1] [Param1] = XXX.XXX.XXX.XXX	>SetNetTcp/Ipv61Ip 192.168.000.001	<TCP/IPV6 1 IP Address 192.168.000.001
>SetNetTcp/Ipv61Gw	Définir la passerelle pour TCP/IPV6: >SetNetTcp/Ipv61Gw [Param1][Param2] [Param1] = 1-2 [Param2] = XXX.XXX.XXX.XXX	>SetNetTcp/Ipv61Gw 1 192.168.000.254 >SetNetTcp/Ipv61Gw 2 192.168.000.254	<TCP/IPV6 1 Gateway Address1 192.168.000.254 <TCP/IPV6 1 Gateway Address2 192.168.000.254
>SetNetTcp/Ipv62Protocol	Activer/Désactiver le protocole TCP/IPV6 >SetNetTcp/Ipv62Protocol [Param1] [Param1] = On,Off	>SetNetTcp/Ipv62Protocol On >SetNetTcp/Ipv62Protocol Off	<TCP/IPV6 2 Protocol On <TCP/IPV6 2 Protocol Off
>SetNetTcp/Ipv62Dhcp	Activer/Désactiver DHCP TCP/IPV6 >SetNetTcp/Ipv62Dhcp [Param1] [Param1] = On,Off	>SetNetTcp/Ipv62Dhcp On >SetNetTcp/Ipv62Dhcp Off	<TCP/IPV6 2 DHCP On <TCP/IPV6 2 DHCP Off
>SetNetTcp/Ipv62Ip	Définir une adresse IP pour TCP/IPV6 >SetNetTcp/Ipv62Ip [Param1] [Param1] = XXX.XXX.XXX.XXX	>SetNetTcp/Ipv62Ip 192.168.000.001	<TCP/IPV6 2 IP Address 192.168.000.001
>SetNetTcp/Ipv62Gw	Définir la passerelle pour TCP/IPV6: >SetNetTcp/Ipv62Gw [Param1][Param2] [Param1] = 1-2 [Param2] = XXX.XXX.XXX.XXX	>SetNetTcp/Ipv62Gw 1 192.168.000.254 >SetNetTcp/Ipv62Gw 2 192.168.000.254	<TCP/IPV6 2 Gateway Address1 192.168.000.254 <TCP/IPV6 2 Gateway Address2 192.168.000.254
>FactoryReset	Reset usine de l'appareil.	>FactoryReset	<FactoryReset
>Reboot	Redémarrer MCU et GUI	>Reboot	<Reboot
>Resta	Redémarrer MCU	>Resta	<System Restart

Lindy vérifie et teste régulièrement sa gamme de produits pour garantir une compatibilité et des performances maximales. Pour obtenir la version la plus récente de ce manuel, veuillez vous référer à votre site Web Lindy local, rechercher le numéro de pièce correspondant et trouver le manuel sous la rubrique Téléchargements.

Introduzione

Vi ringraziamo per aver acquistato IPower Switch 4 porte. Questo prodotto è stato progettato per garantirvi la massima affidabilità e semplicità di utilizzo ed è coperto da 3 anni di garanzia LINDY oltre che da un servizio di supporto tecnico a vita. Per assicurarvi di farne un uso corretto vi invitiamo a leggere attentamente questo manuale e a conservarlo per future consultazioni.

Questo IPower switch è progettato per il controllo e il monitoraggio dell'alimentazione tramite TCP/IP, al fine di fornire una comoda gestione remota dell'alimentazione. Gli amministratori di sistema possono controllare l'alimentazione di più dispositivi, workstation, switch, router ecc., gestendo le funzioni di accensione e spegnimento con monitoraggio del consumo energetico tramite una web GUI di facile utilizzo, RS-232 o comandi API.

Istruzioni di sicurezza

! ATTENZIONE !

Per favore leggete la seguente informativa e conservate sempre questo documento con il prodotto.

La mancata osservanza di questa precauzione può causare seri infortuni o la morte per folgorazione, incendi o danneggiare il prodotto.



Questo dispositivo un alimentatore a commutazione che può funzionare con tensioni di alimentazione all'interno del range 100...250 VAC.

Toccare i componenti interni o cavi danneggiati può causare uno shock elettrico che può condurre alla morte.

Per ridurre il rischio di incendi, folgorazione o danni:

- Non aprite il prodotto. Non esistono componenti utilizzabili all'interno.
- La riparazione o manutenzione del prodotto può essere effettuata solo da personale qualificato.
- Non utilizzare mai cavi danneggiati
- Non fate entrare il prodotto in contatto con acqua e non utilizzatelo in luoghi umidi
- Questo prodotto è pensato esclusivamente per l'uso in ambienti interni
- Non posizionate il prodotto nelle vicinanze di sorgenti di calore. Installatelo sempre in luoghi ben ventilati.
- Non appoggiate oggetti pesanti sul prodotto o sui cavi.
- Vi preghiamo di assicurarvi che ogni adattatore sia fermamente inserito e bloccato in sede prima di collegarlo a una presa di corrente.

Informazioni sulla sicurezza e sulla salute: I prodotti LINDY sono progettati per un uso sicuro ed efficace. Leggere questa guida per informazioni essenziali sulla sicurezza e sulla salute e per i dettagli sulla garanzia limitata del prodotto. Il rispetto di queste istruzioni per l'installazione, l'uso e la manutenzione aumenta il comfort, la produttività e la sicurezza. La mancata osservanza di queste linee guida può provocare scosse elettriche, incendi, lesioni gravi o danni al prodotto o alle cose. Ulteriore assistenza è disponibile su www.lindy.com.

Attenzione: Tenere fuori dalla portata dei bambini. I prodotti e gli accessori LINDY non sono giocattoli e non devono essere maneggiati da bambini piccoli, in quanto possono causare lesioni o danni.

Pericolo di soffocamento: Per i prodotti contenenti o forniti in sacchetti di plastica, tenere i sacchetti lontano da neonati e bambini per evitare il soffocamento.

Sicurezza dell'alimentazione: Si applica ai prodotti che utilizzano un alimentatore AC. Utilizzare solo l'alimentatore AC originale o compatibile specificato per il prodotto. La mancata osservanza di queste indicazioni può provocare scosse elettriche, incendi, lesioni gravi o danni al prodotto.

Uso corretto: Tenere il dispositivo lontano dall'umidità, compresi pioggia, neve o acqua, ed evitare di posizionarlo vicino a fonti di calore, cibo, sporco eccessivo, polvere, olio, sostanze chimiche o luce solare diretta. Per i dispositivi dotati di porte, evitare di inserire oggetti, di lasciare che si accumulino polvere o di utilizzare fonti di calore come asciugacapelli o microonde per asciugare il dispositivo. Se il dispositivo si bagna, pulire delicatamente l'esterno con un panno asciutto.

Uso ad alto rischio: questo prodotto non è destinato ad applicazioni in cui un guasto potrebbe causare morte, lesioni gravi o danni ambientali significativi ("uso ad alto rischio"). L'uso in tali applicazioni è esclusivamente a rischio dell'utente.

Atmosfere esplosive: Non conservare o trasportare materiali infiammabili o esplosivi accanto a questo prodotto o ai suoi accessori. Staccare sempre la spina e spegnere il prodotto ed evitare di caricarlo in aree con atmosfere potenzialmente esplosive.

Connettori e porte dei cavi: Per evitare scosse o incendi quando si utilizzano connettori con un alimentatore, evitare il contatto durante l'uso. Tenere i connettori al riparo da umidità, sporcizia e agenti contaminanti. Interrompere l'uso e contattare l'assistenza se un connettore appare danneggiato.

Pulizia: Per ridurre al minimo i rischi di incendio, scosse elettriche o danni al prodotto, scollegare tutti i cavi e spegnere il dispositivo e gli accessori prima di pulirli. Utilizzare un panno asciutto per pulire solo l'esterno. Evitare di inserire oggetti nelle porte e non immergere i connettori in liquidi, ma pulirli e asciugarli accuratamente.

Rischio di riparazioni: Il tentativo di aprire o riparare questo prodotto può esporre a rischi di scosse elettriche, incendi o lesioni. LINDY raccomanda vivamente di ricorrere a servizi di riparazione professionali, poiché le riparazioni non autorizzate possono invalidare la garanzia.

ATTENZIONE

Irritazione cutanea: Questo prodotto contiene materiali comunemente utilizzati in elettronica che possono causare irritazioni cutanee ad alcuni utenti. Per ridurre questo rischio, pulire regolarmente il dispositivo, evitare di applicare lozioni in prossimità delle aree di contatto e interrompere l'uso in caso di irritazione. Se i sintomi persistono, consultare un medico.

Sicurezza dei cavi: I cavi esposti possono rappresentare un rischio di inciampo. Disporre i cavi in modo da evitare rischi di inciampo o di trazione e proteggerli da schiacciamenti, curve strette ed esposizione al calore. Ispezionare regolarmente i cavi e interromperne l'uso se danneggiati. Scollegare i cavi durante i temporali o in caso di stoccaggio a lungo termine.

AVVISO

Problemi legati al calore: Il prodotto può diventare caldo durante l'uso regolare. Evitare il contatto prolungato con la pelle, garantire un'adeguata ventilazione e utilizzare il prodotto in aree ben ventilate per evitare il surriscaldamento e il disagio.

Dispositivi medici personali: Le emissioni elettroniche e i campi magnetici dei prodotti LINDY possono interferire involontariamente con i dispositivi medici, nonostante la conformità alle normative. Se si sospetta un'interferenza, spegnere immediatamente il prodotto. Per indicazioni sull'utilizzo di dispositivi elettronici nelle vicinanze, consultare il produttore del dispositivo medico o il proprio operatore sanitario.

Manipolazione: Maneggiare il prodotto LINDY con cura. Il prodotto potrebbe danneggiarsi in caso di caduta, foratura o esposizione a liquidi. Se si sospetta un danno, interrompere l'uso del prodotto per evitare potenziali rischi.

Contenuto della confezione

- Switch IPower a 4 porte
- Kit di montaggio con staffe
- Cavo RS232 a 3 pin a DB9 femmina, 1.35m
- Cavi di alimentazione Schuko e UK a IEC C13, 1.8m
- 4 piedini in gomma
- Manuale Lindy

Caratteristiche

- 4 porte di uscita IEC C13 10A per i dispositivi
- Ingresso alimentazione IEC C14 10A
- Controllo dell'alimentazione, monitoraggio della tensione, della corrente e del consumo energetico
- Gestione tramite interfaccia web, RS-232, API e pulsanti sul pannello frontale
- Protocolli Telnet, Modbus TCP, SSH, SNMP e MQTT supportati
- 2 porte di rete RJ-45 ridondanti
- Protezione da sovraccarico ed errori di cablaggio e verifica del login remoto
- Supporta numerosi protocolli di sicurezza, di rete e IoT

Specifiche

- Alimentazione: 110-250V 50/60Hz 10A
- Consumo a vuoto: 1.53W
- Potenza commutata (totale): max. 2500W (2640W, 10A a 264V impostando la soglia di tensione)
- Indicatori LED
- Intervallo di tensione: 110~250V (90~264V impostando la soglia di tensione)
- Intervallo di corrente: 0~10A
- Intervallo di frequenza: 45~65Hz
- Temperatura di esercizio: -10~55°C (14°F~131°F)
- Temperatura di stoccaggio: -20~70°C (-4°F~158°F)
- Umidità relativa: 0~95% (senza condensa)

Installazione

Fronte

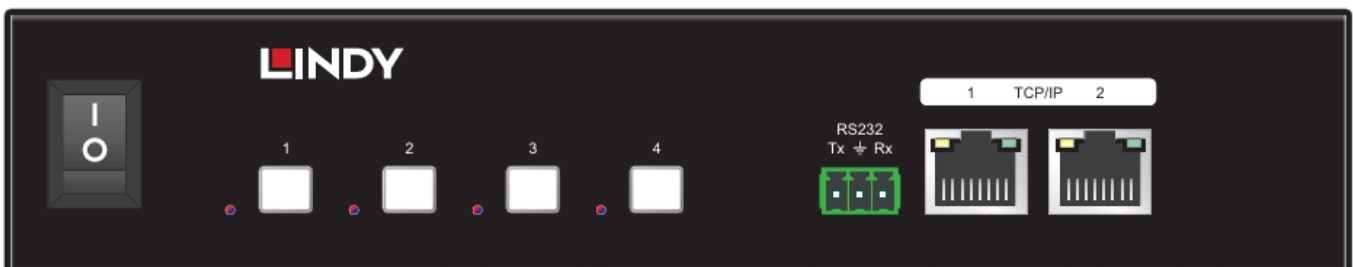

- TASTO POWER: accende/spegne l'unità.
- TASTI 1-2-3-4: gestione manuale dell'alimentazione per ciascuna porta di uscita.
Stato LED:
Blu: alimentazione accesa
Blu lampeggiante: inizializzazione della porta prima dell'accensione
Rosso: porta di uscita sovraccarica
Rosso lampeggiante: porta di uscita in fase di riavvio
- RS232: collegamento a un PC, controller seriale o dispositivo seriale tramite morsettiera a 3 pin per la trasmissione passante dei comandi RS-232 e API.
- TCP/IP 1-2: due porte RJ-45 ridondanti per la connessione di rete per accedere alla web GUI.

Retro

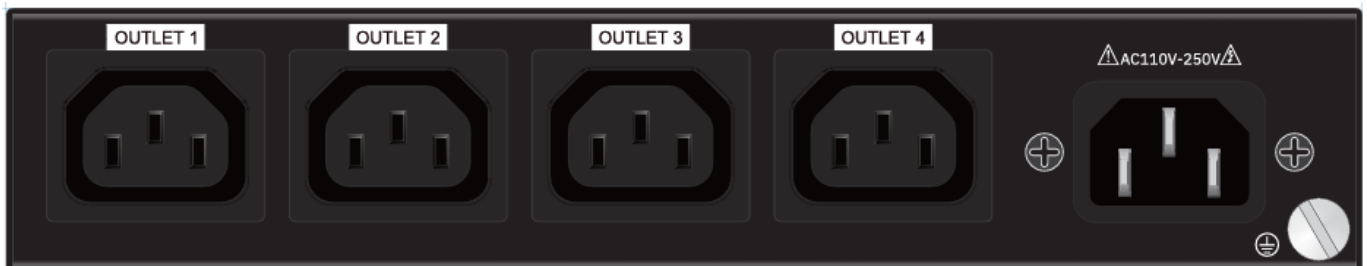

- OUTLET 1-2-3-4: porte IEC C13 per alimentare i dispositivi collegati.
- AC 110V~250V: porta di ingresso IEC C14 per alimentare l'unità.

Collegare tutti i dispositivi alle porte OUTLET, quindi accendere l'unità e i dispositivi.

Utilizzo

Web GUI

Collegare la porta TCP/IP RJ-45 alla rete locale o collegarsi direttamente alla porta TCP/IP 1. Di default, l'unità è impostata in modalità DHCP. Per ottenere automaticamente l'indirizzo IP assegnato dinamicamente, collegare l'unità a una rete con DHCP.

È possibile ottenere l'indirizzo IP corrente anche collegando l'unità alla porta RS232 e inviando il comando >getstatus, come mostrato nella schermata seguente:

```
<TCP/IP1 DHCP On
<TCP/IP1 IP Address 192.168.000.178
<TCP/IP1 Gateway Address 169.254.002.001
<TCP/IP1 Subnet Mask 255.255.255.000
<MAC1 Address CC:8C:DA:36:79:91
<TCP/IP2 DHCP On
<TCP/IP2 IP Address 169.254.002.225
<TCP/IP2 Gateway Address 169.254.002.001
<TCP/IP2 Subnet Mask 255.255.000.000
<MAC2 Address CC:8C:DA:36:79:90
<mDNS On
<mDNS Name Lindy-32622
<TCP/IPv61 Protocol Off
<TCP/IPv61 DHCP Off
<TCP/IPv61 IP Address
<TCP/IPv61 Gateway Address1
<TCP/IPv61 Gateway Address2
<TCP/IPv62 Protocol Off
<TCP/IPv62 DHCP Off
<TCP/IPv62 IP Address
<TCP/IPv62 Gateway Address1
<TCP/IPv62 Gateway Address2
```

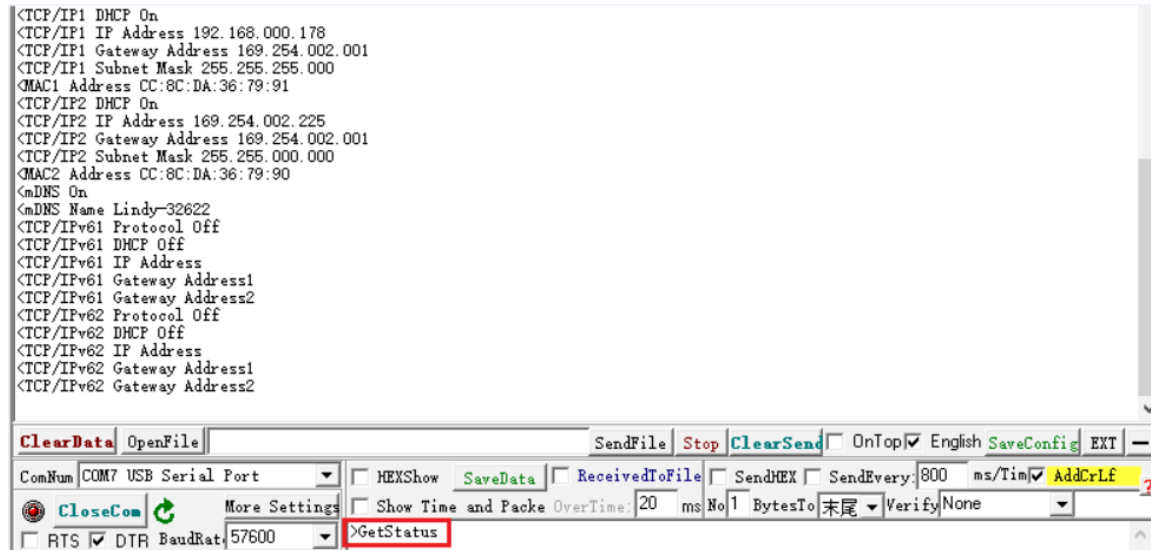

Se nella rete non è presente un server DHCP, come ad esempio un router, l'unità ripristinerà le seguenti impostazioni IP predefinite:

Porta 1: 192.168.0.178

Porta 2: 169.254.2.225

Subnet Mask 1: 255.255.255.0

Subnet Mask 2: 255.255.0.0

Gateway: 192.168.0.1

Porta Telnet: 4001

Digitare l'indirizzo IP nel browser per aprire la pagina di accesso.

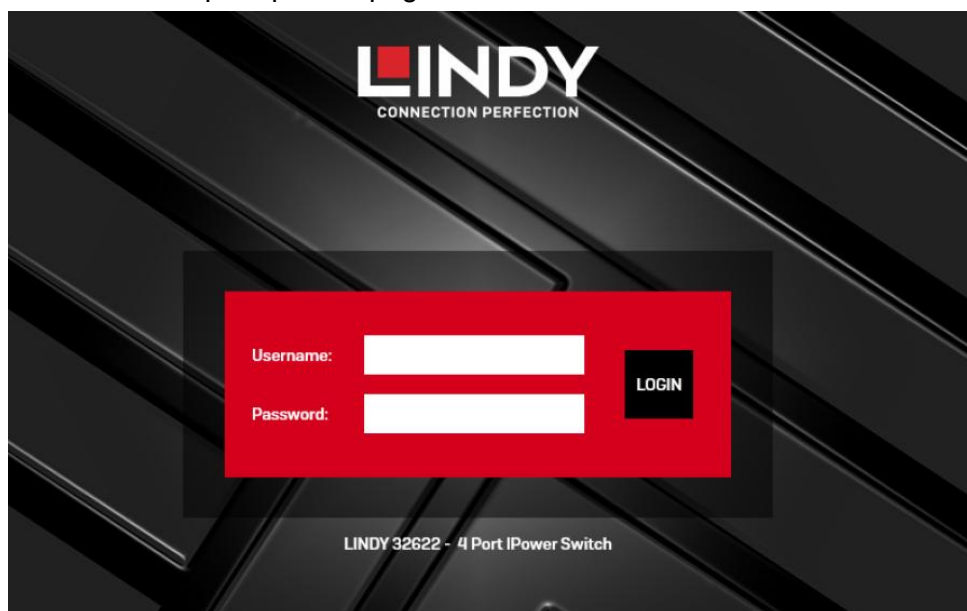

Nome utente predefinito: admin

Password predefinita: aP?y43Tq

Digita il nome utente e la password predefiniti, quindi fai clic su **LOGIN**.

Importante: modificare immediatamente la password predefinita

Per proteggere il prodotto e i dati personali, è necessario modificare la password predefinita il prima possibile dopo la configurazione.

Questo prodotto è conforme al regolamento PSTI (Product Security and Telecommunications Infrastructure) vigente in UK, che richiede che tutte le password predefinite siano uniche o generate per ogni dispositivo. Tuttavia, per mantenere il massimo livello di sicurezza, è essenziale impostare una password forte e facile da ricordare.

Come modificare la password:

1. Accendere il dispositivo e connettersi all'interfaccia web.
2. Accedere utilizzando le credenziali predefinite come sopra.
3. Aprire la pagina **Security > Web-GUI login pass**.
4. Immettere la nuova password e confermare.
5. Salvare le modifiche e accedere nuovamente utilizzando la nuova password.

Suggerimenti per una password complessa:

- Utilizzare almeno 8 caratteri (consigliamo 12+)
- Includere lettere maiuscole e minuscole
- Aggiungere numeri e caratteri speciali (!, @, #, ecc.)
- Evitare parole comuni o informazioni personali

La mancata modifica della password predefinita può esporre il dispositivo a rischi per la sicurezza. Se hai bisogno di assistenza, contatta il nostro team di assistenza clienti.

Dashboard

The dashboard features a top navigation bar with tabs: Dashboard, Network, Schedule, Protocols, Email, Clock, System, and Security. The main content area is divided into several sections:

- System Controls:** Includes 'ALL ON' (green) and 'ALL OFF' (red) buttons, 'SYSTEM RESTART', and 'ALL METERS RESET'.
- Summary Metrics:** Displays 'Total Current' (9.9 A) and 'Total Power' (2400.0 W), 'Total Energy Consumed' (999999.9 kWh), 'Voltage' (240 V), and 'Frequency' (50 Hz) with 'Power Factor' (0.8).
- Outlet Management:** Four outlet cards (OUTLET 1-4) each showing a power icon, 'RS' (Reset) button, 'ON/OFF' status, and a table of 'Current' (9.9 A), 'Power' (2400.0 W), 'Vo.' (240V), 'PF' (0.75), and 'Energy Consumed' (999999.9 kWh). Each card has a 'Settings' button.
- Settings Panel (OUTLET 1):** A detailed configuration area for 'Outlet 1' with fields for 'Outlet Label' (set to 'Outlet 1'), 'Outlet Re-Power Delay', 'Outlet Power-Off Delay', and 'Meters Reset Duration', all in seconds. A 'Save Changes' button is at the bottom.
- Footer:** A red bar at the bottom contains 'System Time: 2024-12-11 11:59', 'Uptime: 90days 12 hrs 59 mins', 'GUI Version: 1.0.0.1', 'System auto logout in 15mins', and buttons for 'Maintenance' and 'Logout'.

- **ALL ON/ALL OFF:** accende/spegne tutte e 4 le prese.
- **SYSTEM RESTART:** riavvia l'unità.
- **ALL METERS RESET:** reset dei contatori delle 4 prese.
- **OUTLET 1-2-3-4**
RS: reset dell'energia consumata.
ON/OFF: accensione/spegnimento.
Settings: rinomina la presa, imposta i ritardi di riaccensione e spegnimento e imposta il

reset della durata dei contatori.

Save Changes: clicca per salvare le impostazioni della presa.

Network

The screenshot shows the Network configuration page. It includes sections for TCP/IP 1 and 2 settings, IPv6 settings, and general network options like ICMP PING, HTTP/HTTPS servers, and mDNS. A footer bar displays system time (2024-12-11 11:59), uptime (90days 12 hrs 59 mins), GUI version (1.0.0.1), and system auto logout in 15mins. There are also buttons for Maintenance and Logout.

Impostazioni di rete, IPv4 e IPv6 per entrambe le porte TCP/IP, PING on/off, server HTTP e mDNS.

Schedule

The screenshot shows the Schedule configuration page. It includes a 'Schedule Settings' section with a dropdown for 'Schedule Timer for' (set to 'ALL OUTLETS') and buttons for 'Turn ON All Time' and 'Turn OFF All Time'. Below this is a grid for scheduling power states by day and hour. A legend indicates that green boxes represent 'Power ON' and red boxes represent 'Power OFF'. A footer bar displays system time (2024-12-11 11:59), uptime (90days 12 hrs 59 mins), GUI version (1.0.0.1), and system auto logout in 15mins. There are also buttons for Maintenance and Logout.

Selezionare le prese e programmare lo stato di accensione/spengimento per giorni e ore (verde = acceso, rosso = spento)

Protocols

Dashboard	Network	Schedule	Protocols	Email	Clock	System	Security
-----------	---------	----------	------------------	-------	-------	--------	----------

SNMP	Telnet	MQTT	SSH	Modbus TCP
-------------	--------	------	-----	------------

Enable SNMP V1 Options SNMP GET SNMP SET

SNMP UDP Port

sysContact

sysName

sysLocation

Enable SNMP V2C Yes No

Enable SNMP V3 Yes No

Enable SNMP Trap V1 Trap V2C Trap V3 Trap
 Disable SNMP Trap

SNMP Trap Receiver 1

SNMP Trap Receiver 2

System Time: 2024-12-11 11:59 Uptime: 90days 12 hrs 59 mins GUI Version: 1.0.0.1 System auto logout in 15mins

Selezionare i protocolli disponibili tra SNMP, Telnet, MQTT, SSH e Modbus TCP per stabilire la connessione necessaria. Ogni finestra fornisce la configurazione del protocollo selezionato.

Email

Dashboard	Network	Schedule	Protocols	Email	Clock	System	Security
-----------	---------	----------	-----------	--------------	-------	--------	----------

SMTP Settings

SMTP Server

SMTP Server Port

Connection Encryption NONE SSL/TLS STARTTLS

Enable SMTP Authentication Yes No

Username

Password

Repeat Password

Default Sender Name

Send System Daily Reports Yes No
Report send only when alarm happens if not tick Yes.

Daily Report Time (hh:mm)

Email Testing

SMTP Setting must be completed before email testing.

To Recipients

Seperate by ',' to send multiple recipients, for example: user1@email.com,user2@email.com

From Sender

Fill in custom email sender address, leave blank by using default address

Custom Email Content

Email Topic

Using system default topic when custom topic is no set.

To Recipients

Seperate by ',' to send multiple recipients, for example: user1@email.com,user2@email.com

System Time: 2024-12-11 11:59 Uptime: 90days 12 hrs 59 mins GUI Version: 1.0.0.1 System auto logout in 15mins

Configurare il server e l'account email per ricevere avvisi e rapporti.

Clock

Dashboard	Network	Schedule	Protocols	Email	Clock	System	Security
-----------	---------	----------	-----------	-------	-------	--------	----------

NTP Settings

Enable NTP Server Yes No

Primary NTP Server

Secondary NTP Server

Timezone

Daylight Saving Time (DST) Yes No

Clock Format 12-hour 24-hour

[Save Changes](#)

Manual Settings

Set Date Manually (yyyy-mm-dd)

Set Time Manually (hh:mm)

Clock Format 12-hour 24-hour

[Save Changes](#)

System Time: 2024-12-11 11:59
Uptime: 90days 12 hrs 59 mins
GUI Version: 1.0.0.1
System auto logout in 15mins
Maintenance
Logout

Configurare le impostazioni dell'ora manualmente o tramite connessione Internet abilitando il server NTP.

System

Dashboard	Network	Schedule	Protocols	Email	Clock	System	Security
-----------	---------	----------	-----------	-------	-------	--------	----------

System Settings

Front Panel Lock Yes No

Device Name

Login Timeout min (Default: 15mins)

Warning Beeper Time s (Default: 10s)

Standby Mode Standby Mode Sleep Mode

[Save Changes](#)

Overload Processing Power off the overloaded outlet

Power off all outlets, then system standby

Auto recover retries, in mins [1-10, Default 3]

Overcurrent Threshold A (Max: 10.9A)

[Save Changes](#)

System Time: 2024-12-11 11:59
Uptime: 90days 12 hrs 59 mins
GUI Version: 1.0.0.1
System auto logout in 15mins
Maintenance
Logout

Pagina delle impostazioni di sistema, sblocco dei pulsanti del pannello frontale, timeout di accesso, tempo del segnale acustico di avviso, elaborazione del sovraccarico e soglia di sovracorrente.

Security

Navigation: Dashboard | Network | Schedule | Protocols | Email | Clock | System | **Security**

Security Settings

Web-GUI Login

Password:

RADIUS

Enable Radius Client: Yes No

Authentication Protocol: PAP CHAP

Use Message Authentication: Yes No

Default Session Timeout: seconds

Primary Server:

New Shared Password:

Repeat Password:

Timeout:

Retries:

System Time: 2024-12-11 11:59 | Uptime: 90days 12 hrs 59 mins | GUI Version: 1.0.0.1 | System auto logout in 15mins |

Impostazioni di sicurezza, modifica della password di accesso e dei parametri del client radius.

Maintenance

Maintenance

System Logs

04-12-2023 23:59:59 Critical Outlet-3 Overvoltage	<input type="button" value="View Log File"/> <input type="button" value="Clear Log File"/> <input type="button" value="Export Log File"/>
04-12-2023 23:59:59 Normal Outlet-1 Power On	
04-12-2023 23:59:59 Critical Outlet-2 Overcurrent	
04-12-2023 23:59:59 Normal Outlet-4 Power Off	
04-12-2023 23:59:59 Normal Outlet- 1 Power On	
04-12-2023 23:59:59 Normal Outlet-2 Reset Meter	
04-12-2023 23:59:59 Normal Outlet-3 Reset Meter	
04-12-2023 23:59:59 Normal Outlet- 4 Power Off	
04-12-2023 23:59:59 Normal Outlet- 1 Power On	
04-12-2023 23:59:59 Normal Outlet- 1 Power On	

Firmware Update

Current Firmware version: 1.1.1.1

SSL Certificate Upload

Config Import

Config Export

Fare clic sul pulsante Maintenance per visualizzare i registri di sistema, aggiornare il firmware, caricare il certificato SSL, importare ed esportare la configurazione, riavviare il dispositivo, ripristinare le impostazioni di fabbrica e svuotare la cache DNS.

Comandi

Indirizzo IP porta 1: 192.168.0.178

Indirizzo IP porta 2: 169.254.2.225

Porta Telnet: 4001

Velocità di trasmissione: 57600 (predefinita)

Bit dati: 8

Bit di stop: 1

Bit di controllo: nessuno

Terminatore: <CR><LF>

Codice di feedback comando errore: <Command Error <Out of Range

Comando	Funzione	Esempio	Risposta
>?/Help	Visualizza la lista di tutti i comandi	>? >Help	Tutti i comandi disponibili
>GetStatus	Controlla lo stato dei dispositivi.	>GetStatus	<Lindy-32622 <V1.0.0a <GetPowerStatus On <GetKeyStatus On <GetTCP/IPEnable 1 <GetRS232Baud 57600 <GetSystemCurrentThreshold 10.9A <Outlet 1 Off <Outlet 2 Off <Outlet 3 Off <Outlet 4 Off <GetGroundStatus Properly Grounded <GetOutletMode 1 Idle <GetOutletMode 2 Idle <GetOutletMode 3 Idle <GetOutletMode 4 Idle <GetOutletPowerOnTime 1 1s <GetOutletPowerOnTime 2 2s <GetOutletPowerOnTime 3 3s <GetOutletPowerOnTime 4 4s <GetOutletPowerOffTime 1 1s <GetOutletPowerOffTime 2 2s <GetOutletPowerOffTime 3 3s <GetOutletPowerOffTime 4 4s <GetOutletEleResetTime 1 10s <GetOutletEleResetTime 2 10s <GetOutletEleResetTime 3 10s <GetOutletEleResetTime 4 10s <GetSafeMode Outlet_Shutdown <GetStandbyMode All_Standby_Mode <GetOverloadRetryCnt 1 <GetOverloadRetryTime 3mins

			<p><GetBeeperTime 10s <TCP/IP1 DHCP Off <TCP/IP1 IP Address 169.254.000.178 <TCP/IP1 Gateway Address <TCP/IP1 Subnet Mask 255.255.000.000 <MAC1 Address CC:8C:DA:00:00:00 <TCP/IP2 DHCP Off <TCP/IP2 IP Address 192.168.000.200 <TCP/IP2 Gateway Address 192.168.000.001 <TCP/IP2 Subnet Mask 255.255.255.000 <MAC2 Address CC:8C:DA:00:00:00 <mDNS Off <mDNS Name Lindy-32622 <TCP/IPv61 Protocol Off <TCP/IPv61 DHCP Off <TCP/IPv61 IP Address <TCP/IPv61 Gateway Address1 <TCP/IPv61 Gateway Address2 <TCP/IPv62 Protocol Off <TCP/IPv62 DHCP Off <TCP/IPv62 IP Address <TCP/IPv62 Gateway Address1 <TCP/IPv62 Gateway Address2</p>
>GETOUTLETSTAT US	<p>Controlla lo stato della singola uscita. >GETOUTLETSTATUS [Param1] [Param1] = 0-4</p>	>GETOUTLETSTATUS 1	<Outlet 1 On
>GetElesta	<p>Controlla le informazioni elettriche come consumi, voltaggi, correnti, ecc.</p>	>GetElesta	<p>< Lindy-32622 <V1.0.0a <Total Current 0.000A <Total Power 0.000W <Total Energy Consumed 0.000000kWh <Voltage 232.199V <Frequency 49.54Hz <Power Factor 0.00 <GetOutletVoltage 1 0.000V <GetOutletVoltage 2 0.000V <GetOutletVoltage 3 0.000V <GetOutletVoltage 4 0.000V <GetOutletCurrent 1 0.000A <GetOutletCurrent 2 0.000A <GetOutletCurrent 3 0.000A <GetOutletCurrent 4 0.000A <GetOutletPower 1 0.000W <GetOutletPower 2 0.000W <GetOutletPower 3 0.000W <GetOutletPower 4 0.000W <GetOutletConsumed 1 0.000000kWh</p>

			<p><GetOutletConsumed 2 0.000000kWh <GetOutletConsumed 3 0.000000kWh <GetOutletConsumed 4 0.000000kWh <GetOutletPowerFactor 1 0.00 <GetOutletPowerFactor 2 0.00 <GetOutletPowerFactor 3 0.00 <GetOutletPowerFactor 4 0.00</p>
>GetFwVersion	Controlla la versione FW.	>GetFwVersion	<p><FW VersiOn: V1.0.0a <GUI VersiOn: V1.0.0a</p>
>SetDeviceName	<p>Imposta il nome del dispositivo. >SetDeviceName: [Param1] [Param1] deve essere il nome che si desidera impostare. (massimo 14 caratteri)</p>	>SetDeviceName: Lindy-32622	<Device Name: Lindy-32622
>SetPower	<p>Entrata/Uscita dalla modalità standby . >SetPower [Param1] [Param1] = On,Off On - Power on Off - Power off</p>	<p>>SetPower On >SetPower Off</p>	<p><System Power Off <System Power On, Please Wait A Moment... Done</p>
>SetKeyLock	<p>Bloccare/Sbloccare i bottoni sul pannello frontale. >SetKeyLock [Param1] [Param1] = On,Off On-GetKeyStatus Off Off- GetKeyStatus On</p>	<p>>SetKeyLock On >SetKeyLock Off</p>	<p><KeyLock On <KeyLock Off</p>
>SetCurrentThreshold	<p>Impostare la soglia di Corrente. >SetCurrentThreshold [Param1] [Param1] = 0.0-10.9</p>	>SetCurrentThreshold 10	<System Current Threshold 10.0A
>SetVoltageThreshold	<p>Impostare la soglia di Voltaggio. >SetVoltageThreshold [Param1] [Param1] =198-264</p>	>SetVoltageThreshold 264	<System Voltage Threshold 264V
>SetSafeMode	<p>Impostare un'azione di ciò che il sistema farà in caso di sovraccarico. >SetSafeMode [Param1] [Param1] = 0-2 0: Outlet_Shutdown 1: System_Shutdown 2:Auto_Retry</p>	<p>>SetSafeMode 0 >SetSafeMode 1 >SetSafeMode 2</p>	<p><System Safe Mode: Outlet_Shutdown <System Safe Mode: System_Shutdown <System Safe Mode: Auto_Retry</p>
>SetOverloadRetryCnt	<p>Impostare il numero di riavvii del sistema in caso di sovraccarico. >SetOverloadRetryCnt [Param1] [Param1] = 1-3 1(Default)</p>	<p>>SetOverloadRetryCnt 1 >SetOverloadRetryCnt 2 >SetOverloadRetryCnt 3</p>	<p><System Retry Number 1 <System Retry Number 2 <System Retry Number 3</p>
>SetOverloadRetryTime	<p>Impostare un tempo di ritardo per il riavvio del sistema in caso di sovraccarico. (espressa in minuti) >SetOverloadRetryTime [Param1] [Param1] = 1-10 3(Default)</p>	>SetOverloadRetryTime 1	<System Retry Delay Time 1mins
>SetStandbyMode	<p>Impostare una modalità di standby per il sistema. >StandbyMode [Param1] [Param1] = 0-1 0: Tutto in modalità standby (l'interfaccia grafica non risponde) 1: Modalità Sleep (l'interfaccia</p>	<p>>SetStandbyMode 0 >SetStandbyMode 1</p>	<p><System Standby Mode: All_Standby_Mode <System Standby Mode: Sleep_Mode</p>

	grafica è reattiva, nessuno scambio di dati con l'MCU)		
>SetRs232Baud	<p>Impostare un baudrate per la RS232</p> <p>>SetRs232Baud [Param1]</p> <p>[Param1] = 1-7</p> <p>1: 2400</p> <p>2: 4800</p> <p>3: 9600</p> <p>4: 19200</p> <p>5: 38400</p> <p>6: 57600(Default)</p> <p>7: 115200</p>	>SetRs232Baud 6	<RS232Baud 57600
>SetRs232Out	<p>RS232 Passante</p> <p>>SetRs232Out [Param1][Param2][Param3][Param4]</p> <p>[Param1] = a,h</p> <p>a: ASCII</p> <p>h: HEX</p> <p>[Param2] = 1-7</p> <p>1: 2400</p> <p>2: 4800</p> <p>3: 9600</p> <p>4: 19200</p> <p>5: 38400</p> <p>6: 57600(Default),</p> <p>7: 115200</p> <p>[Param3] = 1-3</p> <p>1: None</p> <p>2: Even</p> <p>3: Odd</p> <p>Param4 = string</p>	>SETR232OUT a:6:1:RS232	RS232
>SetBeeperTime	<p>Imposta la durata del buzzer. (l'unità di misura in secondi)</p> <p>>SetBeeperTime [Param1]</p> <p>[Param1] = 0: 9999</p> <p>10(Default)</p>	>SetBeeperTime 10	<Buzzer Sound Time 10s
>SetOutletTime	<p>Impostare un tempo di attesa per l'accensione e lo spegnimento di una presa. (unità di misura: secondi)</p> <p>>SetOutlet[Param1]Time [Param2][Param3]</p> <p>[Param1] = On,Off</p> <p>[Param2] = 1-4</p> <p>1: Outlet1</p> <p>2: Outlet2</p> <p>3: Outlet3</p> <p>4: Outlet4</p> <p>[Param3] = 2-9999 (On)/ 0-9999 (Off)</p>	<p>>SetOutletOnTime 1:1</p> <p>>SetOutletOffTime 1:1</p>	<p><Outlet 1 Power_On Delay 1s</p> <p><Outlet 1 Power_Off Delay 1s</p>
>SetOutletEleResetTime	<p>Impostare un tempo di ritardo per reimpostare i valori di una presa specifica sulla GUI.</p> <p>>SetOutletEleResetTime[Param1][Param2]</p> <p>[Param1] = 1-4</p> <p>1: Outlet1</p> <p>2: Outlet2</p> <p>3: Outlet3</p>	>SetOutletEleResetTime 1:10	<Outlet 1 Electrical Work Reset Duration 10s

	4: Outlet4 [Param2] = 0-9999 10(Default)		
>SetAllOut	Accendere/spengere tutte le prese. >SetAllOut [Param1] [Param1] = On,Off	>SetAllOut On >SetAllOut Off	<All Outlets On <All Outlets Off
>SetOutlet	Accensione e spegnimento di una singola presa. >SetOutlet [Param1][Param2] [Param1] = 1-4 1: Outlet1 2: Outlet2 3: Outlet3 4: Outlet4 [Param2] = On,Off	>SetOutlet 1 On	<Outlet 1 On
>RsAllOutEle	Azzeramento dei valori di misurazione visualizzati sulla GUI per tutte le prese.	>RsAllOutEle	<Clean Up Electrical Work: All Outlets
>RsOutEle	Azzerare i valori di misurazione visualizzati sulla GUI per una presa specifica. >RsOutEle [Param1] [Param1] = 1-4 1: Outlet1 2: Outlet2 3: Outlet3 4: Outlet4	>RsOutEle 1	<Clean Up Electrical Work: Outlet 1
>GetSysTime	Ottenere l'ora della data e dell'ora del sistema.	>GetSysTime	<GetSystemTime: 2023-05-11 02:47:16 Thu
>SetSysTime	Impostare la data e l'ora del dispositivo: >SetSysTime [Param1] [Param1] = year-month-day;hour-minutes-seconds	>SetSysTime 2025-03-18;11-26-59	<SetSystemTime: 2025-03-18 11:26:59
>SetNetTcp/IpEnable	Abilitare/disabilitare il TCP/IP: >SetNetTcp/IpEnable [Param1] [Param1] = 1-2 1: TCP/IP1 2: TCP/IP2	>SetNetTcp/IpEnable 1 >SetNetTcp/IpEnable 2	<TCP/IP1 Enable <TCP/IP2 Enable
>SetNetTcp/Ip1Dhcp	Attivare/disattivare il DHCP per TCP/IP1: >SetNetTcp/Ip1Dhcp [Param1] [Param1] = On,Off	>SetNetTcp/Ip1Dhcp On >SetNetTcp/Ip1Dhcp Off	<TCP/IP1 DHCP On <TCP/IP1 DHCP Off
>SetNetTcp/Ip1Ip	Impostare un indirizzo IP per TCP/IP1: >SetNetTcp/Ip1Ip [Param1] [Param1] = XXX.XXX.XXX.XXX	>SetNetTcp/Ip1Ip 192.168.000.001	<TCP/IP1 IP Address 192.168.000.001
>SetNetTcp/Ip1Gw	Impostare un gateway per TCP/IP1: >SetNetTcp/Ip1Gw [Param1] [Param1] = XXX.XXX.XXX.XXX	>SetNetTcp/Ip1Gw 192.168.000.254	<TCP/IP1 Gateway Address 192.168.000.254
>SetNetTcp/Ip1Sm	Impostare una subnet per TCP/IP1: >SetNetTcp/Ip1Sm [Param1] [Param1] = XXX.XXX.XXX.XXX	>SetNetTcp/Ip1Sm 192.168.000.254	<TCP/IP1 Subnet Mask 192.168.000.254
>SetNetTcp/Ip2Dhcp	Attivare/disattivare il DHCP di TCP/IP2: >SetNetTcp/Ip2Dhcp [Param1] [Param1] = On,Off	>SetNetTcp/Ip2Dhcp On >SetNetTcp/Ip2Dhcp Off	<TCP/IP2 DHCP On <TCP/IP2 DHCP Off
>SetNetTcp/Ip2Ip	Impostare un indirizzo IP per TCP/IP2: >SetNetTcp/Ip2Ip [Param1] [Param1] = XXX.XXX.XXX.XXX	>SetNetTcp/Ip2Ip 192.168.000.001	<TCP/IP2 IP Address 192.168.000.001

>SetNetTcp/Ip2Gw	Impostare il gateway per TCP/IP2: >SetNetTcp/Ip2Gw [Param1] [Param1] = XXX.XXX.XXX.XXX	>SetNetTcp/Ip2Gw 192.168.000.254	<TCP/IP2 Gateway Address 192.168.000.254
>SetNetTcp/Ip2Sm	Impostare la subnet per TCP/IP2 >SetNetTcp/Ip2Sm [Param1] [Param1]	>SetNetTcp/Ip2Sm 192.168.000.254	<TCP/IP2 Subnet Mask 192.168.000.254
>SetNetMdns	Attivare/disattivare mDNS: >SetNetMdns [Param1] [Param1] = On,Off	>SetNetMdns On >SetNetMdns Off	<mDNS On <mDNS Off
>SetNetRb	Riavviare il servizio IP	>SetNetRb	<Network Reboot And Apply New Config
>SetNetTcp/Ipv61Protocol	Attivazione/disattivazione del protocollo TCP/IPv6 (1°Lan): >SetNetTcp/Ipv61Protocol [Param1] [Param1] = On,Off	>SetNetTcp/Ipv61Protocol On >SetNetTcp/Ipv61Protocol Off	<TCP/IPv6 1 Protocol On <TCP/IPv6 1 Protocol Off
>SetNetTcp/Ipv61Dhcp	Attivazione/disattivazione del DHCP per TCP/IPv6 (1°Lan): >SetNetTcp/Ipv61Dhcp [Param1] [Param1] = On,Off	>SetNetTcp/Ipv61Dhcp On >SetNetTcp/Ipv61Dhcp Off	<TCP/IPv6 1 DHCP On <TCP/IPv6 1 DHCP Off
>SetNetTcp/Ipv61Ip	Impostare un indirizzo IP per TCP/IPv6 (1°Lan): >SetNetTcp/Ipv61Ip [Param1] [Param1] = XXX.XXX.XXX.XXX	>SetNetTcp/Ipv61Ip 192.168.000.001	<TCP/IPv6 1 IP Address 192.168.000.001
>SetNetTcp/Ipv61Gw	Impostare il gateway per TCP/IPv6 (1°Lan): >SetNetTcp/Ipv61Gw [Param1][Param2] [Param1] = 1-2 [Param2] = XXX.XXX.XXX.XXX	>SetNetTcp/Ipv61Gw 1 192.168.000.254 >SetNetTcp/Ipv61Gw 2 192.168.000.254	<TCP/IPv6 1 Gateway Address1 192.168.000.254 <TCP/IPv6 1 Gateway Address2 192.168.000.254
>SetNetTcp/Ipv62Protocol	Attivazione/disattivazione del protocollo TCP/IPv6 (2°Lan) >SetNetTcp/Ipv62Protocol [Param1] [Param1] = On,Off	>SetNetTcp/Ipv62Protocol On >SetNetTcp/Ipv62Protocol Off	<TCP/IPv6 2 Protocol On <TCP/IPv6 2 Protocol Off
>SetNetTcp/Ipv62Dhcp	Attivazione/disattivazione del DHCP TCP/IPv6 (2°Lan) >SetNetTcp/Ipv62Dhcp [Param1] [Param1] = On,Off	>SetNetTcp/Ipv62Dhcp On >SetNetTcp/Ipv62Dhcp Off	<TCP/IPv6 2 DHCP On <TCP/IPv6 2 DHCP Off
>SetNetTcp/Ipv62Ip	Impostare un indirizzo IP per TCP/IPv6 (2°Lan) >SetNetTcp/Ipv62Ip [Param1] [Param1] = XXX.XXX.XXX.XXX	>SetNetTcp/Ipv62Ip 192.168.000.001	<TCP/IPv6 2 IP Address 192.168.000.001
>SetNetTcp/Ipv62Gw	Impostare il gateway per TCP/IPv6 (2°Lan): >SetNetTcp/Ipv62Gw [Param1][Param2] [Param1] = 1-2 [Param2] = XXX.XXX.XXX.XXX	>SetNetTcp/Ipv62Gw 1 192.168.000.254 >SetNetTcp/Ipv62Gw 2 192.168.000.254	<TCP/IPv6 2 Gateway Address1 192.168.000.254 <TCP/IPv6 2 Gateway Address2 192.168.000.254
>FactoryReset	Ripristino di fabbrica del dispositivo.	>FactoryReset	<FactoryReset
>Reboot	Riavviare l'MCU e la GUI	>Reboot	<Reboot
>Resta	Riavviare l'MCU	>Resta	<System Restart

Lindy controlla e testa regolarmente la propria gamma di prodotti per garantire la massima compatibilità e le migliori prestazioni. Per la versione più aggiornata di questo manuale, consultare il sito Web Lindy locale, cercare il codice pertinente e scaricare il manuale dal campo Download.

Introducción

Gracias por la compra de nuestro producto IPower de 4 puertos. Este producto ha sido diseñado para proporcionar un funcionamiento confiable y sin problemas. Se beneficia tanto de una garantía LINDY 3 años como de nuestro soporte técnico gratuito de por vida. Para garantizar su uso correcto, lea este manual detenidamente y consérvelo para consultarlo en el futuro.

Este conmutador IPower está diseñado para controlar y supervisar la alimentación a través de TCP/IP, lo que permite una cómoda gestión remota de la alimentación. Los administradores del sistema pueden controlar la alimentación de múltiples dispositivos, estaciones de trabajo, conmutadores, routers, etc., lo que permite encender y apagar los dispositivos y supervisar el consumo de energía a través de una interfaz gráfica de usuario web fácil de usar, RS-232 o comandos API.

Información de seguridad

! ADVERTENCIA !

Lea atentamente la siguiente información de seguridad y guarde siempre este documento junto con el producto.

El incumplimiento de estas precauciones puede provocar lesiones graves o la muerte por descarga eléctrica, incendio o daños al producto.

Este dispositivo tiene una fuente de alimentación de tipo conmutable y puede funcionar con voltajes de suministro en el rango de 100... 250 VCA.

Tocar los componentes internos o un cable dañado puede causar una descarga eléctrica que puede resultar en la muerte.

Para reducir el riesgo de incendio, descargas eléctricas o daños:

- No abra el producto. No hay partes internas que puedan ser reparables por el usuario.
- Solo personal de servicio cualificado puede realizar reparaciones o mantenimiento.
- No utilice nunca cables dañados.
- No exponga el producto al agua ni a lugares húmedos.
- No utilice este producto al aire libre, esta únicamente diseñado para su uso en interiores.
- No coloque el producto cerca de fuentes de calor directas. Colóquelo siempre en un lugar bien ventilado.
- No coloque objetos pesados sobre el producto o los cables.
- Asegúrese de que los cables estén firmemente asegurados y bloqueados en su lugar antes de insertarlos en una toma de corriente.

Información sobre seguridad y salud: Los productos LINDY están diseñados para un uso seguro y eficaz. Revise esta guía para obtener información esencial sobre seguridad, salud y detalles sobre la Garantía Limitada de su producto. Seguir estas instrucciones de instalación, uso y cuidado aumenta la comodidad, la productividad y la seguridad. El incumplimiento de estas directrices puede provocar descargas eléctricas, incendios, lesiones graves o daños al producto o a la propiedad. Encontrará ayuda adicional en www.lindy.com.

Advertencia: Manténgase fuera del alcance de los niños. Los productos y accesorios LINDY no son juguetes y no deben ser manipulados por niños pequeños, ya que pueden causar lesiones o daños

Peligro de asfixia: En el caso de productos que contengan o se suministren en bolsas de plástico, mantenga las bolsas alejadas de bebés y niños para evitar que se asfixien.

Seguridad de la fuente de alimentación: Se aplica a los productos que utilizan una fuente de alimentación de CA. Utilice únicamente la fuente de alimentación de CA original o compatible especificada para su producto. El incumplimiento de estas instrucciones puede provocar descargas eléctricas, incendios, lesiones graves o daños en el producto.

Uso adecuado: Mantenga el dispositivo alejado de la humedad, incluida la lluvia, la nieve o el agua, y evite colocarlo cerca de fuentes de calor, alimentos, suciedad excesiva, polvo, aceite, productos químicos o la luz solar directa. En el caso de dispositivos con puertos, evite introducir objetos, permitir que se



acumule polvo o utilizar fuentes de calor como secadores de pelo o microondas para secarlo. Si el dispositivo se moja, limpie suavemente el exterior con un paño seco.

Uso de alto riesgo: Este producto no está diseñado para aplicaciones en las que un fallo podría provocar la muerte, lesiones graves o daños medioambientales significativos («uso de alto riesgo»). El uso en tales aplicaciones es bajo su propia responsabilidad.

Atmósferas explosivas: No almacene ni transporte materiales inflamables o explosivos junto a este producto o sus accesorios. Desenchufe y apague siempre el producto, y evite cargarlo en zonas con atmósferas potencialmente explosivas.

Conectores y puertos de cables: Para evitar descargas o incendios al utilizar conectores con una fuente de alimentación, evite el contacto durante su uso. Mantenga los conectores libres de humedad, suciedad y contaminantes. Deje de utilizarlos y póngase en contacto con el servicio de asistencia técnica si algún conector parece estar dañado.

Limpieza: Para minimizar los riesgos de incendio, descarga eléctrica o daños en el producto, desenchufe todos los cables y apague el dispositivo y los accesorios antes de limpiarlos. Utilice un paño seco para limpiar sólo el exterior. Evite introducir objetos en los puertos y no sumerja los conectores en líquidos; en su lugar, límpielos y séquelos bien.

Riesgo en las reparaciones: Intentar abrir o reparar este producto puede exponerle a riesgos de descarga eléctrica, incendio o lesiones. LINDY recomienda encarecidamente el uso de servicios de reparación profesionales, ya que las reparaciones no autorizadas pueden anular la garantía.

PRECAUCIÓN

Irritación de la piel: Este producto contiene materiales comúnmente utilizados en electrónica que pueden causar irritación en la piel de algunos usuarios. Para reducir este riesgo, limpie el dispositivo con regularidad, evite aplicar lociones cerca de las zonas de contacto e interrumpa el uso si se produce irritación. Consulte a su médico si los síntomas persisten.

Seguridad de los cables: Los cables expuestos pueden suponer un riesgo de tropiezo. Coloque los cables de forma que no haya riesgo de tropiezo o tirón y protéjalos de aplastamientos, curvas cerradas y exposición al calor. Inspeccione regularmente los cables y deje de utilizarlos si están dañados. Desenchufe los cables durante las tormentas eléctricas o en caso de almacenamiento prolongado.

AVISO

Preocupaciones relacionadas con el calor: El producto puede calentarse durante su uso regular. Evite el contacto prolongado con la piel, asegúrese de que haya una ventilación adecuada y utilícelo en zonas con buena circulación para evitar el sobrecalentamiento y las molestias.

Dispositivos médicos personales: Las emisiones electrónicas y los campos magnéticos de los productos LINDY pueden interferir involuntariamente con dispositivos médicos, a pesar del cumplimiento normativo. Si sospecha que se producen interferencias, apague el producto inmediatamente. Para obtener orientación sobre el uso de dispositivos electrónicos en las proximidades, consulte al fabricante de su dispositivo médico o a su profesional sanitario.

Manipulación: Manipule su producto LINDY con cuidado. El producto puede dañarse si se cae, se pincha o se expone a líquidos. Si sospecha que se ha producido algún daño, deje de utilizar el producto para evitar posibles peligros.

Contenido del paquete

- Conmutador IPower de 4 puertos
- Kit de montaje con soportes
- Cable RS232 de 3 pines a DB9 hembra, 1.35m
- Cables Schuko y UK a IEC C13, 1.8m
- 4 patas de goma
- Manual Lindy

Características

- 4 puertos de salida IEC C13 10A para los dispositivos
- Entrada de alimentación IEC C14 10A
- Control de la alimentación, supervisión del voltaje, la corriente y el consumo de energía
- Gestión a través de la interfaz gráfica de usuario web, RS-232, API y botones del panel frontal
- Protocolos Telnet, Modbus TCP, SSH, SNMP y MQTT compatibles

- 2 puertos de red RJ-45 redundantes
- Protección contra sobrecargas y errores de cableado y verificación de inicio de sesión remoto
- Compatible con numerosos protocolos de seguridad, red e IoT

Especificaciones

- Fuente de alimentación: 110-250V, 50/60Hz, 10A
- Consumo sin carga: 1.53W
- Potencia conmutada (total): máx. 2500W (2640W, 10A a 264V ajustando el umbral de tensión)
- Indicadores LED
- Rango de tensión: 110~250V (90~264V ajustando el umbral de tensión)
- Rango de corriente: 0~10A
- Rango de frecuencia: 45~65Hz
- Temperatura de funcionamiento: -10~55°C (14°F~131°F)
- Temperatura de almacenamiento: -20~70°C (-4°F~158°F)
- Humedad relativa: 0-95% (sin condensación)

Instalación

Parte frontal

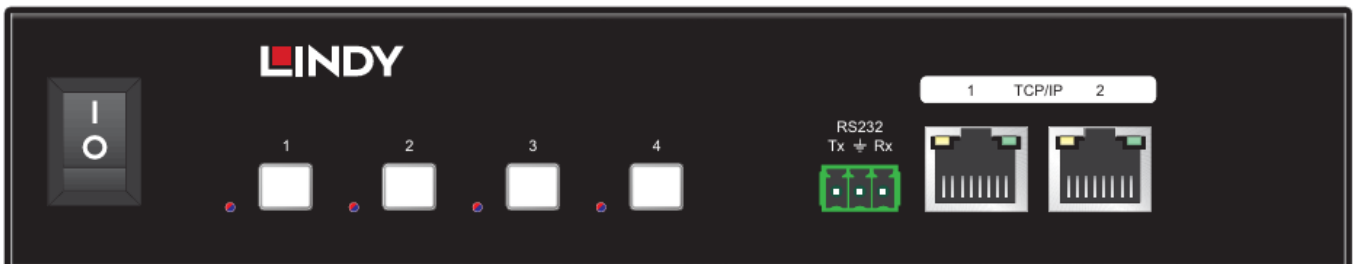

- POWER BUTTON: enciende/apaga la unidad.
- BUTTON 1-2-3-4: gestión manual de la alimentación de cada puerto de salida.
Estado de los LED:
Azul: encendido
Azul parpadeante: inicialización del puerto antes del encendido
Rojo: el puerto de salida está sobrecargado
Rojo intermitente: el puerto de salida se está reiniciando
- RS232: conexión a un PC, controlador serie o dispositivo serie a través de una conexión de 3 vías con bloque Phoenix para la transmisión de paso de comandos RS-232 y API.
- TCP/IP 1-2: dos puertos RJ-45 redundantes para la conexión de red y el acceso al control GUI web.

Parte trasera

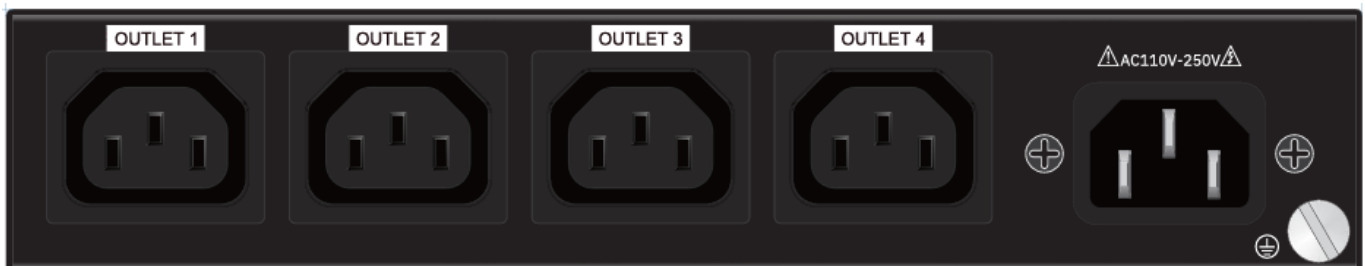

- OUTLET 1-2-3-4: puertos IEC C13 para alimentar los dispositivos conectados.
- AC 110V~250V: puerto de entrada IEC C14 para alimentar la unidad.

Conecte todos los dispositivos a los puertos OUTLET y, a continuación, encienda la unidad y los dispositivos.

Operación

Interfaz gráfica de usuario web

Conecte el puerto TCP/IP RJ-45 a la red local o conéctelo directamente al puerto TCP/IP 1. De forma predeterminada, la unidad está configurada en modo DHCP. Para obtener automáticamente la dirección IP asignada dinámicamente, conecte la unidad a una red habilitada para DHCP.

También es posible obtener la dirección IP actual conectando la unidad al puerto RS232 y enviando el comando >getstatus, como se muestra en la siguiente captura de pantalla:

```
<TCP/IP1 DHCP On
<TCP/IP1 IP Address 192.168.000.178
<TCP/IP1 Gateway Address 169.254.002.001
<TCP/IP1 Subnet Mask 255.255.255.000
<MAC1 Address CC:8C:DA:36:79:91
<TCP/IP2 DHCP On
<TCP/IP2 IP Address 169.254.002.225
<TCP/IP2 Gateway Address 169.254.002.001
<TCP/IP2 Subnet Mask 255.255.000.000
<MAC2 Address CC:8C:DA:36:79:90
<mDNS On
<mDNS Name Lindy-32622
<TCP/IPv61 Protocol Off
<TCP/IPv61 DHCP Off
<TCP/IPv61 IP Address
<TCP/IPv61 Gateway Address1
<TCP/IPv61 Gateway Address2
<TCP/IPv62 Protocol Off
<TCP/IPv62 DHCP Off
<TCP/IPv62 IP Address
<TCP/IPv62 Gateway Address1
<TCP/IPv62 Gateway Address2
```

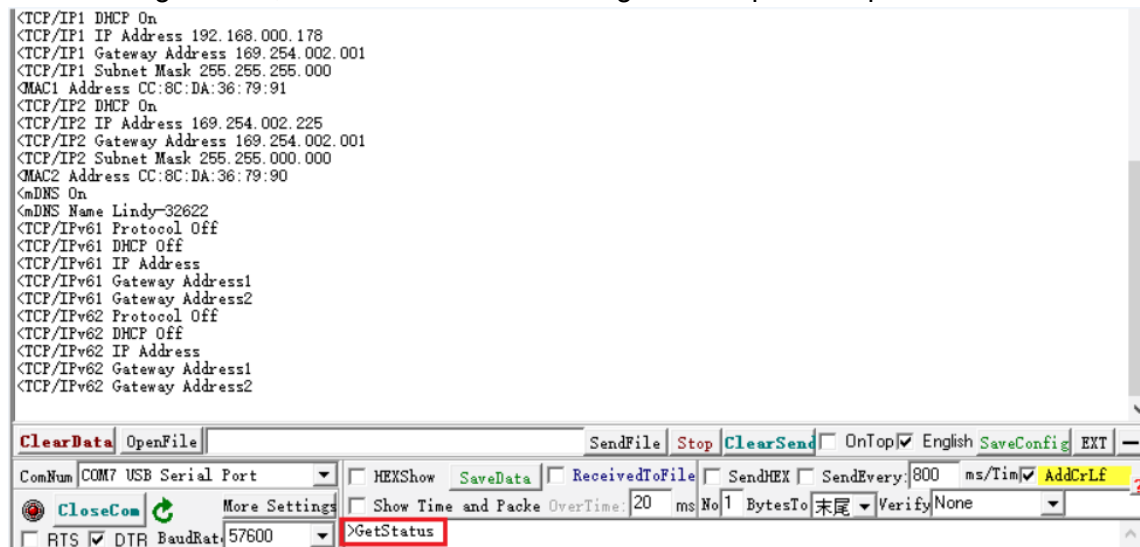

Si no hay un servidor DHCP, como un router, en la red, la unidad volverá a la siguiente configuración IP predeterminada:

Puerto 1: 192.168.0.178

Puerto 2: 169.254.2.225

Máscara de subred 1: 255.255.255.0

Máscara de subred 2: 255.255.0.0

Puerta de enlace: 192.168.0.1

Puerto Telnet 4001

Escriba la dirección IP en el navegador para abrir la página de inicio de sesión.

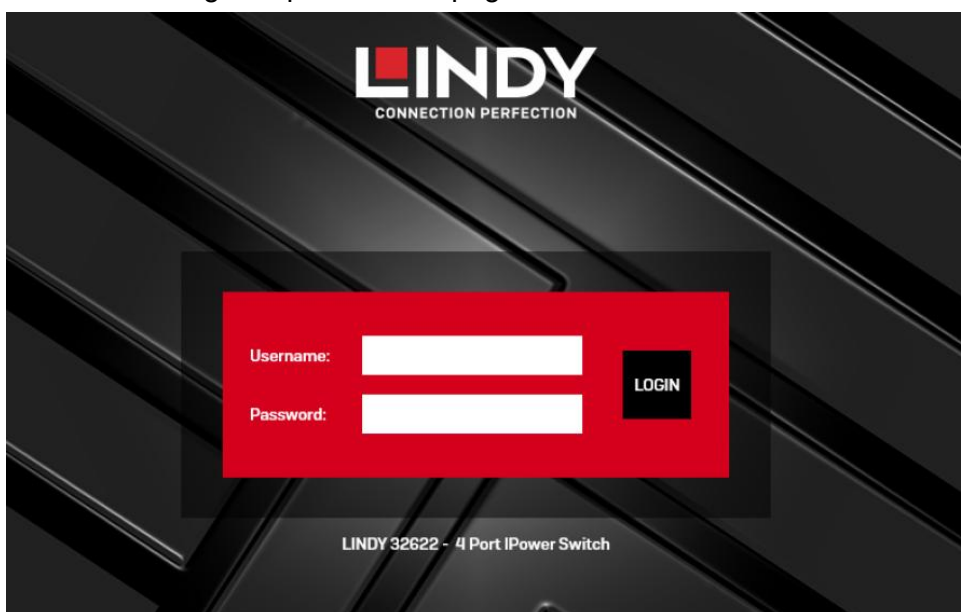

Nombre de usuario predeterminado: admin

Contraseña predeterminada: aP?y43Tq

Escriba el nombre de usuario y la contraseña predeterminados y, a continuación, haga clic en **LOGIN**.

Importante: cambie la contraseña predeterminada inmediatamente

Para proteger su producto y sus datos personales, debe cambiar la contraseña predeterminada lo antes posible después de la configuración.

Este producto cumple con la normativa británica sobre seguridad de productos y infraestructuras de telecomunicaciones (PSTI), que exige que todas las contraseñas predeterminadas sean únicas o se generen para cada dispositivo. Sin embargo, para mantener el máximo nivel de seguridad, es esencial que establezca una contraseña segura y fácil de recordar.

Cómo cambiar la contraseña:

1. Encienda el dispositivo y conéctese a él mediante la interfaz web.
2. Inicie sesión con las credenciales predeterminadas indicadas anteriormente.
3. Vaya a **Security > Web-GUI login pass**.
4. Introduzca su nueva contraseña y confírmela.
5. Guarde los cambios e inicie sesión de nuevo con la nueva contraseña.

Consejos para crear una contraseña segura:

- Utilice al menos 8 caracteres (recomendamos 12 o más).
- Incluya letras mayúsculas y minúsculas.
- Añada números y caracteres especiales (!, @, #, etc.).
- Evite palabras comunes o información personal.

Si no cambia la contraseña predeterminada, su dispositivo podría quedar expuesto a riesgos de seguridad. Si necesita ayuda, póngase en contacto con nuestro equipo de atención al cliente.

Dashboard

The dashboard features a top navigation bar with tabs: Dashboard (active), Network, Schedule, Protocols, Email, Clock, System, and Security. Below the navigation bar, there are several sections:

- System Controls:** Includes buttons for 'ALL ON', 'ALL OFF', 'SYSTEM RESTART', and 'ALL METERS RESET'. Summary statistics show Total Current (9.9 A), Total Power (2400.0 W), Total Energy Consumed (999999.9 kWh), Voltage (240 V), Frequency (50 Hz), and Power Factor (0.8). A note indicates 'Energy measured since: 2023-5-1 12:34'.
- Outlet Status:** Four outlets (OUTLET 1-4) are shown, each with a power icon, 'RS' (Reset) button, and 'ON/OFF' status. Each outlet displays Current (9.9 A) and Power (2400.0 W). Below each outlet is a table with columns: Vo. (240V), PF (0.75), and Energy Consumed (999999.9 kWh). A 'Settings' button is located below each outlet.
- Settings Panel (OUTLET 1):** A detailed settings window for Outlet 1, including:
 - Outlet Label: 'Outlet 1' (limit: <= 10 Chars)
 - Outlet Re-Power Delay: [] seconds
 - Outlet Power-Off Delay: [] seconds
 - Meters Reset Duration: [] seconds
 - 'Save Changes' button

The footer of the dashboard displays: System Time: 2024-12-11 11:59, Uptime: 90days 12 hrs 59 mins, GUI Version: 1.0.0.1, System auto logout in 15mins, and buttons for 'Maintenance' and 'Logout'.

- **ALL ON/ALL OFF:** enciende/apaga los 4 enchufes.
- **SYSTEM RESTART:** reinicia la unidad.
- **ALL METERS RESET:** reinicia los medidores de las 4 salidas.
- **OUTLET 1-2-3-4**
RS: reinicia la energía consumida.
ON/OFF: encendido/apagado.
Settings: cambiar el nombre de la toma, establecer los retardos de reencendido y apagado y la

duración del reinicio de los contadores.

Save Changes: haga clic para guardar la configuración de la toma.

Network

The screenshot shows the Network configuration page. It includes sections for TCP/IP 1 Settings, TCP/IP 2 Settings, and IPv6 Settings. There are also sections for ICMP PING, HTTP/HTTPS servers, and mDNS. A footer bar shows system time, uptime, GUI version, and auto-logout timer, along with Maintenance and Logout buttons.

Schedule

The screenshot shows the Schedule configuration page. It features a grid for scheduling power on/off by day and hour. There are also buttons for 'Turn ON All Time' and 'Turn OFF All Time'. A footer bar shows system time, uptime, GUI version, and auto-logout timer, along with Maintenance and Logout buttons.

Seleccione las salidas y programe el estado de encendido/apagado por días y horas (verde es encendido, rojo es apagado).

Protocols

Dashboard	Network	Schedule	Protocols	Email	Clock	System	Security
-----------	---------	----------	------------------	-------	-------	--------	----------

SNMP | Telnet | MQTT | SSH | Modbus TCP

Enable SNMP V1 Options SNMP GET SNMP SET

SNMP UDP Port

sysContact

sysName

sysLocation

Enable SNMP V2C Yes No

Enable SNMP V3 Yes No

Enable SNMP Trap V1 Trap V2C Trap V3 Trap
 Disable SNMP Trap

SNMP Trap Receiver 1

SNMP Trap Receiver 2

System Time: 2024-12-11 11:59 Uptime: 90days 12 hrs 59 mins GUI Version: 1.0.0.1 System auto logout in 15mins

Seleccione los protocolos disponibles entre SNMP, Telnet, MQTT, SSH y Modbus TCP para establecer la conexión necesaria. Cada ventana proporciona la configuración del protocolo seleccionado.

Email

Dashboard	Network	Schedule	Protocols	Email	Clock	System	Security
-----------	---------	----------	-----------	--------------	-------	--------	----------

SMTP Settings

SMTP Server

SMTP Server Port

Connection Encryption NONE SSL/TLS STARTTLS

Enable SMTP Authentication Yes No

Username

Password

Repeat Password

Default Sender Name

Send System Daily Reports Yes No
Report send only when alarm happens if not tick Yes.

Daily Report Time (hh:mm)

Email Testing

SMTP Setting must be completed before email testing.

To Recipients

Seperate by ',' to send multiple recipients, for example: user1@email.com,user2@email.com

From Sender

Fill in custom email sender address, leave blank by using default address

Custom Email Content

Email Topic

Using system default topic when custom topic is no set.

To Recipients

Seperate by ',' to send multiple recipients, for example: user1@email.com,user2@email.com

System Time: 2024-12-11 11:59 Uptime: 90days 12 hrs 59 mins GUI Version: 1.0.0.1 System auto logout in 15mins

Configure el servidor de correo electrónico y la cuenta para recibir avisos e informes.

Clock

Dashboard	Network	Schedule	Protocols	Email	Clock	System	Security
<div style="border: 1px solid #ccc; padding: 10px;"> <div style="background-color: #f0f0f0; padding: 5px; margin-bottom: 10px;">NTP Settings</div> <p>Enable NTP Server <input checked="" type="radio"/> Yes <input type="radio"/> No</p> <p>Primary NTP Server <input type="text" value="0.pool.ntp.org"/></p> <p>Secondary NTP Server <input type="text" value="1.pool.ntp.org"/></p> <p>Timezone <input type="text" value="(GMT-05:00) Eastern Time (US & Canada), Bogota, Lima, Quito"/></p> <p>Daylight Saving Time (DST) <input type="radio"/> Yes <input checked="" type="radio"/> No</p> <p>Clock Format <input checked="" type="radio"/> 12-hour <input type="radio"/> 24-hour</p> <p style="text-align: center;">Save Changes</p> </div> <div style="border: 1px solid #ccc; padding: 10px; margin-top: 10px;">Manual Settings</div> <p>Set Date Manually <input type="text" value="2024-11-01"/> (yyyy-mm-dd)</p> <p>Set Time Manually <input type="text" value="11:59"/> <input type="text" value="AM"/> (hh:mm)</p> <p>Clock Format <input type="radio"/> 12-hour <input type="radio"/> 24-hour</p> <p style="text-align: center;">Save Changes</p>							
System Time: 2024-12-11 11:59 Uptime: 90days 12 hrs 59 mins GUI Version: 1.0.0.1 System auto logout in 15mins Maintenance Logout							

Configure los ajustes de hora manualmente o a través de la conexión a Internet habilitando el servidor NTP.

System

Dashboard	Network	Schedule	Protocols	Email	Clock	System	Security
<div style="border: 1px solid #ccc; padding: 10px;"> <div style="background-color: #f0f0f0; padding: 5px; margin-bottom: 10px;">System Settings</div> <p>Front Panel Lock <input checked="" type="radio"/> Yes <input type="radio"/> No</p> <hr/> <p>Device Name <input type="text"/></p> <p>Login Timeout <input type="text" value="15"/> min (Default: 15mins)</p> <p>Warning Beeper Time <input type="text" value="10"/> s (Default: 10s)</p> <p>Standby Mode <input checked="" type="radio"/> Standby Mode <input type="radio"/> Sleep Mode</p> <p style="text-align: center;">Save Changes</p> <hr/> <p>Overload Processing <input checked="" type="radio"/> Power off the overloaded outlet</p> <p><input type="radio"/> Power off all outlets, then system standby</p> <p><input type="radio"/> Auto recover <input type="text" value="3"/> retries, in <input type="text" value="3"/> mins (1-10, Default 3)</p> <p>Overcurrent Threshold <input type="text" value="10.9"/> A (Max: 10.9A)</p> <p style="text-align: center;">Save Changes</p> </div>							
System Time: 2024-12-11 11:59 Uptime: 90days 12 hrs 59 mins GUI Version: 1.0.0.1 System auto logout in 15mins Maintenance Logout							

Página de configuración del sistema, desbloquea los botones del panel frontal, el tiempo de espera de inicio de sesión, el tiempo del avisador acústico, el procesamiento de sobrecarga y el umbral de sobrecorriente.

Security

Navigation: Dashboard | Network | Schedule | Protocols | Email | Clock | System | **Security**

Security Settings

Web-GUI Login

Password:

RADIUS

Enable Radius Client: Yes No

Authentication Protocol: PAP CHAP

Use Message Authentication: Yes No

Default Session Timeout: seconds

Primary Server:

New Shared Password:

Repeat Password:

Timeout:

Retries:

System Time: 2024-12-11 11:59 | Uptime: 90days 12 hrs 59 mins | GUI Version: 1.0.0.1 | System auto logout in 15mins | |

Ajustes de seguridad, cambie la contraseña de inicio de sesión y los parámetros del cliente radius.

Maintenance

Maintenance

System Logs

04-12-2023 23:59:59 Critical Outlet-3 Overvoltage	<input type="button" value="View Log File"/> <input type="button" value="Clear Log File"/> <input type="button" value="Export Log File"/>
04-12-2023 23:59:59 Normal Outlet-1 Power On	
04-12-2023 23:59:59 Critical Outlet-2 Overcurrent	
04-12-2023 23:59:59 Normal Outlet-4 Power Off	
04-12-2023 23:59:59 Normal Outlet- 1 Power On	
04-12-2023 23:59:59 Normal Outlet-2 Reset Meter	
04-12-2023 23:59:59 Normal Outlet-3 Reset Meter	
04-12-2023 23:59:59 Normal Outlet- 4 Power Off	
04-12-2023 23:59:59 Normal Outlet- 1 Power On	
04-12-2023 23:59:59 Normal Outlet- 1 Power On	

Firmware Update

Current Firmware version: 1.1.1.1

SSL Certificate Upload

Config Import

Config Export

Haga clic en el botón Maintenance para ver los registros del sistema, actualizar el firmware, cargar el certificado SSL, importar y exportar la configuración, reiniciar el dispositivo, restablecer la configuración de fábrica y vaciar la caché DNS.

Comandos

Puerto 1 Dirección IP: 192.168.0.178

Puerto 2 Dirección IP: 169.254.2.225

Puerto Telnet 4001

Velocidad de transmisión: 57600 (por defecto)

Bit de datos 8

Bit de parada:1

Bit de control: ninguno

Terminador: <CR><LF>

Código de retroalimentación de comando de erro: <Command Error <Out of Range

Comando	Función	Ejemplo	Retroalimentación
>?/Help	Enumerar todos los comandos	>? >Help	All the commands list
>GetStatus	Compruebe el estado del dispositivo.	>GetStatus	<Lindy-32622 <V1.0.0a <GetPowerStatus On <GetKeyStatus On <GetTCP/IPEnable 1 <GetRS232Baud 57600 <GetSystemCurrentThreshold 10.9A <Outlet 1 Off <Outlet 2 Off <Outlet 3 Off <Outlet 4 Off <GetGroundStatus Properly Grounded <GetOutletMode 1 Idle <GetOutletMode 2 Idle <GetOutletMode 3 Idle <GetOutletMode 4 Idle <GetOutletPowerOnTime 1 1s <GetOutletPowerOnTime 2 2s <GetOutletPowerOnTime 3 3s <GetOutletPowerOnTime 4 4s <GetOutletPowerOffTime 1 1s <GetOutletPowerOffTime 2 2s <GetOutletPowerOffTime 3 3s <GetOutletPowerOffTime 4 4s <GetOutletEleResetTime 1 10s <GetOutletEleResetTime 2 10s <GetOutletEleResetTime 3 10s <GetOutletEleResetTime 4 10s <GetSafeMode Outlet_Shutdown <GetStandbyMode All_Standby_Mode <GetOverloadRetryCnt 1 <GetOverloadRetryTime 3mins <GetBeeperTime 10s

			<p><TCP/IP1 DHCP Off <TCP/IP1 IP Address 169.254.000.178 <TCP/IP1 Gateway Address <TCP/IP1 Subnet Mask 255.255.000.000 <MAC1 Address CC:8C:DA:00:00:00 <TCP/IP2 DHCP Off <TCP/IP2 IP Address 192.168.000.200 <TCP/IP2 Gateway Address 192.168.000.001 <TCP/IP2 Subnet Mask 255.255.255.000 <MAC2 Address CC:8C:DA:00:00:00 <mDNS Off <mDNS Name Lindy-32622 <TCP/IPv61 Protocol Off <TCP/IPv61 DHCP Off <TCP/IPv61 IP Address <TCP/IPv61 Gateway Address1 <TCP/IPv61 Gateway Address2 <TCP/IPv62 Protocol Off <TCP/IPv62 DHCP Off <TCP/IPv62 IP Address <TCP/IPv62 Gateway Address1 <TCP/IPv62 Gateway Address2</p>
>GETOUTLETSTAT US	<p>Compruebe el estado de una sola toma de corriente. >GETOUTLETSTATUS [Param1] [Param1] = 0-4</p>	>GETOUTLETSTATUS 1	<Outlet 1 On
>GetElesta	<p>Verifique la información de electricidad, como el consumo de energía, el voltaje, la corriente, etc.</p>	>GetElesta	<p>< Lindy-32622 <V1.0.0a <Total Current 0.000A <Total Power 0.000W <Total Energy Consumed 0.000000kWh <Voltage 232.199V <Frequency 49.54Hz <Power Factor 0.00 <GetOutletVoltage 1 0.000V <GetOutletVoltage 2 0.000V <GetOutletVoltage 3 0.000V <GetOutletVoltage 4 0.000V <GetOutletCurrent 1 0.000A <GetOutletCurrent 2 0.000A <GetOutletCurrent 3 0.000A <GetOutletCurrent 4 0.000A <GetOutletPower 1 0.000W <GetOutletPower 2 0.000W <GetOutletPower 3 0.000W <GetOutletPower 4 0.000W <GetOutletConsumed 1 0.000000kWh <GetOutletConsumed 2</p>

			0.000000kWh <GetOutletConsumed 3 0.000000kWh <GetOutletConsumed 4 0.000000kWh <GetOutletPowerFactor 1 0.00 <GetOutletPowerFactor 2 0.00 <GetOutletPowerFactor 3 0.00 <GetOutletPowerFactor 4 0.00
>GetFwVersion	Compruebe la versión del firmware.	>GetFwVersion	<FW VersiOn: V1.0.0a <GUI VersiOn: V1.0.0a
>SetDeviceName	Establecer un apodo para el dispositivo. >SetDeviceName: [Param1] [Param1] debe ser el apodo que desea establecer. (14 characters maximum)	>SetDeviceName: Lindy-32622	<Device Name: Lindy-32622
>SetPower	Entrar/Salir del modo de espera. >SetPower [Param1] [Param1] = On,Off On - Power on Off - Power off	>SetPower On >SetPower Off	<System Power Off <System Power On, Please Wait A Moment... Done
>SetKeyLock	Para bloquear/desbloquear el botón en el panel frontal del dispositivo. >SetKeyLock [Param1] [Param1] = On,Off On-GetKeyStatus Off Off- GetKeyStatus On	>SetKeyLock On >SetKeyLock Off	<KeyLock On <KeyLock Off
>SetCurrentThreshold	Establecer un umbral de corriente para el sistema. >SetCurrentThreshold [Param1] [Param1] = 0.0-10.9	>SetCurrentThreshold 10	<System Current Threshold 10.0A
>SetVoltageThreshold	Establecer un umbral de voltaje para el sistema. >SetVoltageThreshold [Param1] [Param1] =198-264	>SetVoltageThreshold 264	<System Voltage Threshold 264V
>SetSafeMode	Establezca una acción de lo que hará el sistema cuando se sobrecargue. >SetSafeMode [Param1] [Param1] = 0-2 0: Outlet_Shutdown 1: System_Shutdown 2:Auto_Retry	>SetSafeMode 0 >SetSafeMode 1 >SetSafeMode 2	<System Safe Mode: Outlet_Shutdown <System Safe Mode: System_Shutdown <System Safe Mode: Auto_Retry
>SetOverloadRetryCnt	Establezca cuántas veces se reiniciará el sistema cuando se sobrecargue. >SetOverloadRetryCnt [Param1] [Param1] = 1-3 1(Default)	>SetOverloadRetryCnt 1 >SetOverloadRetryCnt 2 >SetOverloadRetryCnt 3	<System Retry Number 1 <System Retry Number 2 <System Retry Number 3
>SetOverloadRetryTime	Establezca un tiempo de retraso para que el sistema se reinicie cuando se sobrecargue. (La unidad es minutos) >SetOverloadRetryTime [Param1] [Param1] = 1-10 3(Default)	>SetOverloadRetryTime 1	<System Retry Delay Time 1mins
>SetStandbyMode	Establezca un modo de espera para el sistema. >StandbyMode [Param1] [Param1] = 0-1	>SetStandbyMode 0 >SetStandbyMode 1	<System Standby Mode: All_Standby_Mode <System Standby Mode: Sleep_Mode

	0: All_Standby_Mode (La GUI no responde) 1: Sleep_Mode (La GUI es receptiva, no hay intercambio de datos con MCU)		
>SetRs232Baud	Establezca una velocidad de transmisión para RS232 >SetRs232Baud [Param1] [Param1] = 1-7 1: 2400 2: 4800 3: 9600 4: 19200 5: 38400 6: 57600(Default), 7: 115200	>SetRs232Baud 6	<RS232Baud 57600
>SetRs232Out	RS232 Passthrough >SetRs232Out [Param1][Param2][Param3][Param4]] [Param1] = a,h a: ASCII h: HEX [Param2] = 1-7 1: 2400 2: 4800 3: 9600 4: 19200 5: 38400 6: 57600(Default), 7: 115200 [Param3] = 1-3 1: None 2: Even 3: Odd Param4 = string	>SETRs232OUT a:6:1:RS232	RS232
>SetBeeperTime	Establezca la duración del tiempo del zumbador. (la unidad es segundos) >SetBeeperTime [Param1] [Param1] = 0: 9999 10(Default)	>SetBeeperTime 10	<Buzzer Sound Time 10s
>SetOutletTime	Establezca un tiempo razonable para que un tomacorriente se encienda / apague. (la unidad es segundos) >SetOutlet[Param1]Time [Param2][Param3] [Param1] = On,Off [Param2] = 1-4 1: Outlet1 2: Outlet2 3: Outlet3 4: Outlet4 [Param3] = 2-9999 (On)/ 0-9999 (Off)	>SetOutletOnTime 1:1 >SetOutletOffTime 1:1	<Outlet 1 Power_On Delay 1s <Outlet 1 Power_Off Delay 1s
>SetOutletEleResetTime	Establezca un tiempo de retardo para restablecer los valores de una salida específica en la GUI. >SetOutletEleResetTime[Param1][Param2]	>SetOutletEleResetTime 1:10	<Outlet 1 Electrical Work Reset Duration 10s

	[Param1] = 1-4 1: Outlet1 2: Outlet2 3: Outlet3 4: Outlet4 [Param2] = 0-9999 10(Default)		
>SetAllOut	Encienda / apague todos los tomacorrientes. >SetAllOut [Param1] [Param1] = On,Off	>SetAllOut On >SetAllOut Off	<All Outlets On <All Outlets Off
>SetOutlet	Encienda / apague un solo tomacorriente. >SetOutlet [Param1][Param2] [Param1] = 1-4 1: Outlet1 2: Outlet2 3: Outlet3 4: Outlet4 [Param2] = On,Off	>SetOutlet 1 On	<Outlet 1 On
>RsAllOutEle	Restablezca los valores medidos que se muestran en la GUI para todas las salidas.	>RsAllOutEle	<Clean Up Electrical Work: All Outlets
>RsOutEle	Restablezca los valores medidos que se muestran en la GUI para una toma de corriente específica. >RsOutEle [Param1] [Param1] = 1-4 1: Outlet1 2: Outlet2 3: Outlet3 4: Outlet4	>RsOutEle 1	<Clean Up Electrical Work: Outlet 1
>GetSysTime	Obtener la hora de la fecha y hora del sistema.	>GetSysTime	<GetSystemTime: 2023-05-11 02:47:16 Thu
>SetSysTime	Establezca la fecha y la hora del dispositivo: >SetSysTime [Param1] [Param1] = year-month-day;hour-minutes-seconds	>SetSysTime 2025-03-18;11-26-59	<SetSystemTime: 2025-03-18 11:26:59
>SetNetTcp/IpEnable	Habilitar/Deshabilitar el TCP/IP: >SetNetTcp/IpEnable [Param1] [Param1] = 1-2 1: TCP/IP1 2: TCP/IP2	>SetNetTcp/IpEnable 1 >SetNetTcp/IpEnable 2	<TCP/IP1 Enable <TCP/IP2 Enable
>SetNetTcp/Ip1Dhcp	Activar/desactivar el DHCP para TCP/IP1: >SetNetTcp/Ip1Dhcp [Param1] [Param1] = On,Off	>SetNetTcp/Ip1Dhcp On >SetNetTcp/Ip1Dhcp Off	<TCP/IP1 DHCP On <TCP/IP1 DHCP Off
>SetNetTcp/Ip1Ip	Establezca una dirección IP para TCP/IP1: >SetNetTcp/Ip1Ip [Param1] [Param1] = XXX.XXX.XXX.XXX	>SetNetTcp/Ip1Ip 192.168.000.001	<TCP/IP1 IP Address 192.168.000.001
>SetNetTcp/Ip1Gw	Establezca una puerta de enlace para TCP/IP1: >SetNetTcp/Ip1Gw [Param1] [Param1] = XXX.XXX.XXX.XXX	>SetNetTcp/Ip1Gw 192.168.000.254	<TCP/IP1 Gateway Address 192.168.000.254
>SetNetTcp/Ip1Sm	Establezca una máscara de subred para TCP/IP1: >SetNetTcp/Ip1Sm [Param1] [Param1] = XXX.XXX.XXX.XXX	>SetNetTcp/Ip1Sm 192.168.000.254	<TCP/IP1 Subnet Mask 192.168.000.254

>SetNetTcp/Ip2Dhcp	Activar/desactivar el DHCP de TCP/IP2: >SetNetTcp/Ip2Dhcp [Param1] [Param1] = On,Off	>SetNetTcp/Ip2Dhcp On >SetNetTcp/Ip2Dhcp Off	<TCP/IP2 DHCP On <TCP/IP2 DHCP Off
>SetNetTcp/Ip2Ip	Establezca una dirección IP para TCP/IP2: >SetNetTcp/Ip2Ip [Param1] [Param1] = XXX.XXX.XXX.XXX	>SetNetTcp/Ip2Ip 192.168.000.001	<TCP/IP2 IP Address 192.168.000.001
>SetNetTcp/Ip2Gw	Configure la puerta de enlace para TCP/IP2: >SetNetTcp/Ip2Gw [Param1] [Param1] = XXX.XXX.XXX.XXX	>SetNetTcp/Ip2Gw 192.168.000.254	<TCP/IP2 Gateway Address 192.168.000.254
>SetNetTcp/Ip2Sm	Establecer la máscara de subred para TCP/IP2 >SetNetTcp/Ip2Sm [Param1] [Param1]	>SetNetTcp/Ip2Sm 192.168.000.254	<TCP/IP2 Subnet Mask 192.168.000.254
>SetNetMdns	Activar/desactivar el mDNS >SetNetMdns [Param1] [Param1] = On,Off	>SetNetMdns On >SetNetMdns Off	<mDNS On <mDNS Off
>SetNetRb	Reiniciar el servicio IP	>SetNetRb	<Network Reboot And Apply New Config
>SetNetTcp/Ipv61Protocol	Activar/desactivar el protocolo TCP/IPv6 >SetNetTcp/Ipv61Protocol [Param1] [Param1] = On,Off	>SetNetTcp/Ipv61Protocol On >SetNetTcp/Ipv61Protocol Off	<TCP/IPv6 1 Protocol On <TCP/IPv6 1 Protocol Off
>SetNetTcp/Ipv61Dhcp	Activar/desactivar el DHCP para TCP/IPv6 >SetNetTcp/Ipv61Dhcp [Param1] [Param1] = On,Off	>SetNetTcp/Ipv61Dhcp On >SetNetTcp/Ipv61Dhcp Off	<TCP/IPv6 1 DHCP On <TCP/IPv6 1 DHCP Off
>SetNetTcp/Ipv61Ip	Establecer una dirección IP para TCP/IPv6 >SetNetTcp/Ipv61Ip [Param1] [Param1] = XXX.XXX.XXX.XXX	>SetNetTcp/Ipv61Ip 192.168.000.001	<TCP/IPv6 1 IP Address 192.168.000.001
>SetNetTcp/Ipv61Gw	Establezca la puerta de enlace para TCP/IPv6: >SetNetTcp/Ipv61Gw [Param1][Param2] [Param1] = 1-2 [Param2] = XXX.XXX.XXX.XXX	>SetNetTcp/Ipv61Gw 1 192.168.000.254 >SetNetTcp/Ipv61Gw 2 192.168.000.254	<TCP/IPv6 1 Gateway Address1 192.168.000.254 <TCP/IPv6 1 Gateway Address2 192.168.000.254
>SetNetTcp/Ipv62Protocol	Activar/desactivar el protocolo TCP/IPv6 >SetNetTcp/Ipv62Protocol [Param1] [Param1] = On,Off	>SetNetTcp/Ipv62Protocol On >SetNetTcp/Ipv62Protocol Off	<TCP/IPv6 2 Protocol On <TCP/IPv6 2 Protocol Off
>SetNetTcp/Ipv62Dhcp	Activar/desactivar el DHCP TCP/IPv6 >SetNetTcp/Ipv62Dhcp [Param1] [Param1] = On,Off	>SetNetTcp/Ipv62Dhcp On >SetNetTcp/Ipv62Dhcp Off	<TCP/IPv6 2 DHCP On <TCP/IPv6 2 DHCP Off
>SetNetTcp/Ipv62Ip	Establecer una dirección IP para TCP/IPv6 >SetNetTcp/Ipv62Ip [Param1] [Param1] = XXX.XXX.XXX.XXX	>SetNetTcp/Ipv62Ip 192.168.000.001	<TCP/IPv6 2 IP Address 192.168.000.001
>SetNetTcp/Ipv62Gw	Establezca la puerta de enlace para TCP/IPv6: >SetNetTcp/Ipv62Gw [Param1][Param2] [Param1] = 1-2 [Param2] = XXX.XXX.XXX.XXX	>SetNetTcp/Ipv62Gw 1 192.168.000.254 >SetNetTcp/Ipv62Gw 2 192.168.000.254	<TCP/IPv6 2 Gateway Address1 192.168.000.254 <TCP/IPv6 2 Gateway Address2 192.168.000.254
>FactoryReset	Restablecimiento de fábrica del dispositivo.	>FactoryReset	<FactoryReset
>Reboot	Reinicie la MCU y la GUI	>Reboot	<Reboot
>Resta	Reiniciar MCU	>Resta	<System Restart

Lindy comprueba y prueba regularmente nuestra gama de productos para garantizar la máxima compatibilidad y rendimiento. Para obtener la versión más actualizada de este manual, consulte el sitio web local de Lindy, busque el número de referencia correspondiente y encontrará el manual en Descargas.

Wprowadzenie

Dziękujemy za zakup 4-portowego przełącznika IPower. Ten produkt został zaprojektowany w celu zapewnienia bezproblemowej, niezawodnej pracy. Korzysta zarówno z 3-letniej gwarancji LINDY, jak i bezpłatnej, dożywotniej pomocy technicznej. Aby zapewnić prawidłowe użytkowanie, przeczytaj uważnie tę instrukcję i zachowaj ją do wykorzystania w przyszłości.

Przełącznik IPower jest przeznaczony do sterowania zasilaniem i monitorowania za pośrednictwem protokołu TCP/IP, zapewniając wygodne zdalne zarządzanie zasilaniem. Administratorzy systemu mogą sterować zasilaniem wielu urządzeń, stacji roboczych, przełączników, routerów itp., umożliwiając włączanie i wyłączanie zasilania oraz monitorowanie zużycia energii za pomocą prostego w obsłudze graficznego interfejsu użytkownika, interfejsu RS-232 lub poleceń API.

Instrukcje bezpieczeństwa

! OSTRZEŻENIE!

Prosimy o uważne zapoznanie się z poniższymi informacjami dotyczącymi bezpieczeństwa i zawsze należy przechowywać ten dokument wraz z produktem.

Nieprzestrzeganie tych środków ostrożności może spowodować poważne obrażenia lub śmierć w wyniku porażenia prądem, pożaru lub uszkodzenia produktu.

To urządzenie posiada zasilacz typu przełączającego i może pracować z napięciami zasilającymi w zakresie 100... 250 V PRĄDU ZMIENNEGO.

Dotknięcie elementów wewnętrznych lub uszkodzonego może spowodować porażenie prądem, które może skutkować śmiercią.

Aby zmniejszyć ryzyko pożaru, porażenia prądem lub uszkodzenia:

- Nie otwieraj produktu. Wewnątrz nie ma części nadających się do serwisowania przez użytkownika.
- Tylko wykwalifikowany personel serwisowy może przeprowadzać wszelkie naprawy lub konserwację.
- Nigdy nie używaj uszkodzonych.
- Nie wystawiać produktu na działanie wody lub miejsc wilgoci.
- Nie używaj tego produktu na zewnątrz, jest on przeznaczony wyłącznie do użytku w pomieszczeniach.
- Nie umieszczaj produktu w pobliżu bezpośrednich źródeł ciepła. Zawsze umieszczaj go w dobrze wentylowanym miejscu.
- Nie umieszczaj ciężkich przedmiotów na produkcie lub.
- Upewnij się, że wszystkie są mocno zabezpieczone i zablokowane na miejscu przed włożeniem do gniazdka elektrycznego

Informacje dotyczące bezpieczeństwa i zdrowia: Produkty LINDY zostały zaprojektowane z myślą o bezpiecznym i efektywnym użytkowaniu. Prosimy o zapoznanie się z niniejszym przewodnikiem w celu uzyskania istotnych informacji na temat bezpieczeństwa i zdrowia oraz szczegółów dotyczących ograniczonej gwarancji na produkt. Przestrzeganie tych instrukcji konfiguracji, użytkowania i konserwacji zwiększa komfort, wydajność i bezpieczeństwo. Nieprzestrzeganie tych wytycznych może spowodować porażenie prądem, pożar, poważne obrażenia ciała lub uszkodzenie produktu lub mienia. Dodatkowe wsparcie jest dostępne na stronie www.lindy.com.

Ostrzeżenie: Przechowywać w miejscu niedostępnym dla dzieci. Produkty i akcesoria LINDY nie są zabawkami i nie powinny być dotykane przez małe dzieci, ponieważ mogą spowodować obrażenia ciała lub uszkodzenie urządzenia.

Niebezpieczeństwo uduszenia: W przypadku produktów zawierających lub dostarczanych w plastikowych torbach, torby należy przechowywać z dala od niemowląt i dzieci, aby zapobiec uduszeniu.

Bezpieczeństwo zasilania: Dotyczy produktów korzystających z zasilacza sieciowego. Należy używać wyłącznie oryginalnego lub zgodnego zasilacza sieciowego przeznaczonego dla danego produktu. Niezastosowanie się do tych zaleceń może spowodować porażenie prądem, pożar, poważne obrażenia ciała lub uszkodzenie produktu.

Prawidłowe użytkowanie: Urządzenie należy przechowywać z dala od wilgoci, w tym deszczu, śniegu lub wody, a także unikać umieszczania go w pobliżu źródeł ciepła, żywności, nadmiernego zabrudzenia, kurzu, oleju, chemikaliów lub bezpośredniego światła słonecznego. W przypadku urządzeń z portami należy unikać wkładania przedmiotów, dopuszczania do gromadzenia się kurzu lub używania źródeł



ciepła, takich jak suszarki do włosów lub kuchenki mikrofalowe, w celu wysuszenia urządzenia. Jeśli urządzenie ulegnie zamoczeniu, należy delikatnie przetrzeć jego obudowę suchą szmatką.

Użytkowanie wysokiego ryzyka: Ten produkt nie jest przeznaczony do zastosowań, w których awaria może prowadzić do śmierci, poważnych obrażeń lub znacznych szkód dla środowiska („użytkowanie wysokiego ryzyka”). Użytkowanie w takich zastosowaniach odbywa się wyłącznie na własne ryzyko.

Atmosfery wybuchowe: Nie należy przechowywać ani transportować materiałów łatwopalnych lub wybuchowych razem z tym produktem lub jego akcesoriami. Zawsze odłączaj i wyłączaj zasilanie produktu oraz unikaj ładowania w obszarach zagrożonych wybuchem.

Złącza i porty kablowe: Aby uniknąć porażenia prądem lub pożaru podczas używania złączy z zasilaczem, należy unikać ich kontaktu podczas użytkowania. Złącza należy chronić przed wilgocią, brudem i zanieczyszczeniami. Jeśli którekolwiek złączy okaże się uszkodzone, należy przerwać użytkowanie i skontaktować się z pomocą techniczną.

Czyszczenie: Aby zminimalizować ryzyko pożaru, porażenia prądem elektrycznym lub uszkodzenia produktu, przed przystąpieniem do czyszczenia należy odłączyć wszystkie przewody i wyłączyć zasilanie urządzenia i akcesoriów. Do czyszczenia obudowy należy używać wyłącznie suchej szmatki. Unikaj wkładania przedmiotów do portów i nie zanurzaj złączy w płynach; zamiast tego dokładnie je wytrzyj i wysusz.

Ryzyko związane z naprawami: Próba otwarcia lub naprawy tego produktu może narazić użytkownika na ryzyko porażenia prądem, pożaru lub obrażeń. Firma LINDY zdecydowanie zaleca korzystanie z profesjonalnych usług naprawczych, ponieważ nieautoryzowane naprawy mogą spowodować utratę gwarancji.

UWAGA

Podrażnienie skóry: Ten produkt zawiera materiały powszechnie stosowane w elektronice, które mogą powodować podrażnienia skóry u niektórych użytkowników. Aby zmniejszyć to ryzyko, należy regularnie czyścić urządzenie, unikać stosowania balsamów w pobliżu miejsc kontaktu i zaprzestać używania, jeśli wystąpi podrażnienie. Jeśli objawy nie ustąpią, należy skonsultować się z lekarzem.

Bezpieczeństwo kabli: Odsonięte kable mogą stwarzać ryzyko potknięcia. Kable należy ułożyć w taki sposób, aby zapobiec ryzyku potknięcia się lub pociągnięcia oraz chronić je przed zgnieceniem, ostrymi zagięciami i wysoką temperaturą. Regularnie sprawdzaj kable i zaprzestań ich używania, jeśli są uszkodzone. Kable należy odłączać podczas burz z wyładowaniami atmosferycznymi lub w przypadku długotrwałego przechowywania.

UWAGA

Obawy związane z ciepłem: Produkt może nagrzewać się podczas regularnego użytkowania. Należy unikać długotrwałego kontaktu ze skórą, zapewnić odpowiednią wentylację i używać w dobrze wentylowanych miejscach, aby zapobiec przegrzaniu i dyskomfortowi..

Osobiste urządzenia medyczne: Emisje elektroniczne i pola magnetyczne z produktów LINDY mogą w sposób niezamierzony zakłócać działanie urządzeń medycznych, pomimo zgodności z przepisami. W przypadku podejrzenia zakłóceń należy natychmiast wyłączyć produkt. Aby uzyskać wskazówki dotyczące korzystania z urządzeń elektronicznych w pobliżu, należy skonsultować się z producentem urządzenia medycznego lub pracownikiem służby zdrowia.

Obsługa: Z produktem LINDY należy obchodzić się ostrożnie. Produkt może ulec uszkodzeniu w przypadku upuszczenia, przebicia lub kontaktu z cieczą. W przypadku podejrzenia uszkodzenia należy zaprzestać korzystania z produktu, aby zapobiec potencjalnym zagrożeniom.

Zawartość opakowania

- 4-portowy przełącznik IPower
- Zestaw montażowy z uchwytami
- Kabel RS232 3-pin do DB9 żeński, 1.35m
- Kabel Schuko i UK do IEC C13, 1.8m
- 4x gumowe nóżki
- Instrukcja obsługi Lindy

Funkcje

- 4 porty wyjściowe IEC C13 10A dla urządzeń
- Wejście zasilania IEC C14 10A
- Sterowanie zasilaniem, monitorowanie napięcia, prądu i zużycia energii

- Zarządzanie za pomocą graficznego interfejsu użytkownika, RS-232, interfejsów API i przycisków na panelu przednim
- Obsługa protokołów Telnet, Modbus TCP, SSH, SNMP i MQTT
- 2 redundantne porty sieciowe RJ-45
- Zabezpieczenie przed przeciążeniem i błędami okablowania, filtrowanie zakłóceń i zdalna weryfikacja logowania
- Obsługa wielu protokołów bezpieczeństwa, sieciowych i IoT

Specyfikacja

- Zasilanie: 110–250V, 50/60Hz, 10A
- Pobór mocy bez obciążenia: 1.53W
- Moc przełączana (łącznie): maks. 2500W (2640W, 10A przy 264V po ustawieniu progu napięcia)
- Wskaźniki LED
- Zakres napięcia: 110–250V (90–264V po ustawieniu progu napięcia)
- Zakres prądu: 0~10A
- Zakres częstotliwości: 45~65Hz
- Temperatura pracy: -10–55°C (14°F–131°F)
- Temperatura przechowywania: -20–70°C (-4°F–158°F)
- Wilgotność względna: 0–95% (bez kondensacji)

Instalacja

Przód

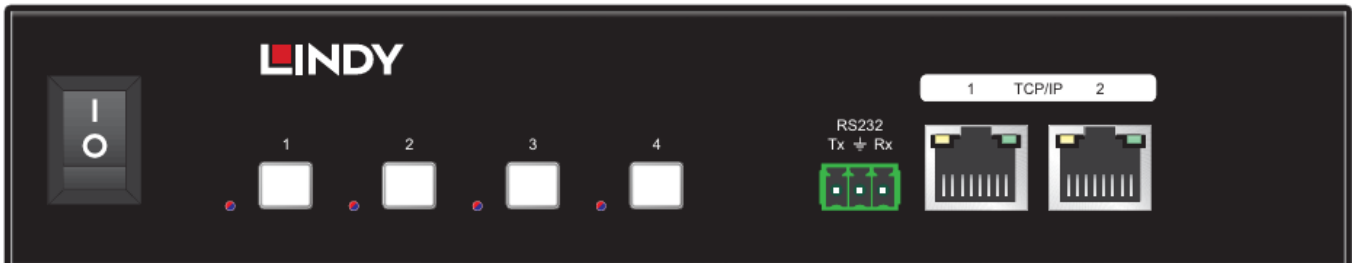

- POWER BUTTON: włącza/wyłącza urządzenie.
- BUTTON 1-2-3-4: ręczne zarządzanie zasilaniem dla każdego portu wyjściowego.
Stan diody LED:
Niebieska: zasilanie włączone
Migająca niebieska: inicjalizacja portu przed włączeniem zasilania
Czerwona: port wyjściowy jest przeciążony
Migająca czerwona: port wyjściowy jest restartowany
- RS232: podłączenie do komputera PC, kontrolera szeregowego lub urządzenia szeregowego za pomocą 3-drożnego złącza blokowego Phoenix w celu transmisji poleceń RS-232 i API.
- TCP/IP 1-2: dwa redundantne porty RJ-45 do podłączenia do sieci w celu uzyskania dostępu do internetowego interfejsu użytkownika.

Tył

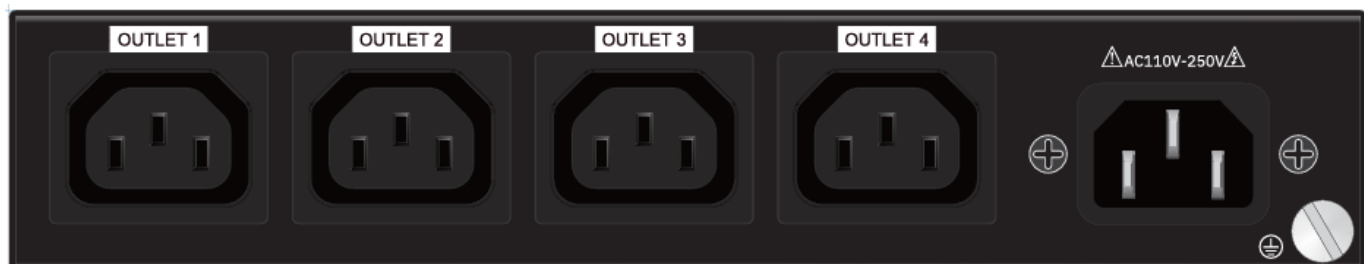

- OUTLET 1-2-3-4: gniazda IEC C13 do zasilania podłączonych urządzeń.
- AC 110V~250V: gniazdo wejściowe IEC C14 do zasilania urządzenia.

Podłącz wszystkie urządzenia do gniazd OUTLET, a następnie włącz urządzenie i urządzenia.

Operacja

Web GUI

Podłącz port TCP/IP RJ-45 do sieci lokalnej lub podłącz bezpośrednio do portu TCP/IP 1. Domyślnie urządzenie jest ustawione w trybie DHCP. Aby automatycznie uzyskać dynamicznie przypisany adres IP, podłącz urządzenie do sieci obsługującej protokół DHCP.

Aktualny adres IP można również uzyskać, podłączając urządzenie do portu RS232 i wysyłając polecenie >getstatus, jak pokazano na poniższym zrzucie ekranu:

```
<TCP/IP1 DHCP On
<TCP/IP1 IP Address 192.168.000.178
<TCP/IP1 Gateway Address 169.254.002.001
<TCP/IP1 Subnet Mask 255.255.255.000
<MAC1 Address CC:8C:DA:36:79:91
<TCP/IP2 DHCP On
<TCP/IP2 IP Address 169.254.002.225
<TCP/IP2 Gateway Address 169.254.002.001
<TCP/IP2 Subnet Mask 255.255.000.000
<MAC2 Address CC:8C:DA:36:79:90
<mDNS On
<mDNS Name Lindy-32622
<TCP/IPv61 Protocol Off
<TCP/IPv61 DHCP Off
<TCP/IPv61 IP Address
<TCP/IPv61 Gateway Address1
<TCP/IPv61 Gateway Address2
<TCP/IPv62 Protocol Off
<TCP/IPv62 DHCP Off
<TCP/IPv62 IP Address
<TCP/IPv62 Gateway Address1
<TCP/IPv62 Gateway Address2
```

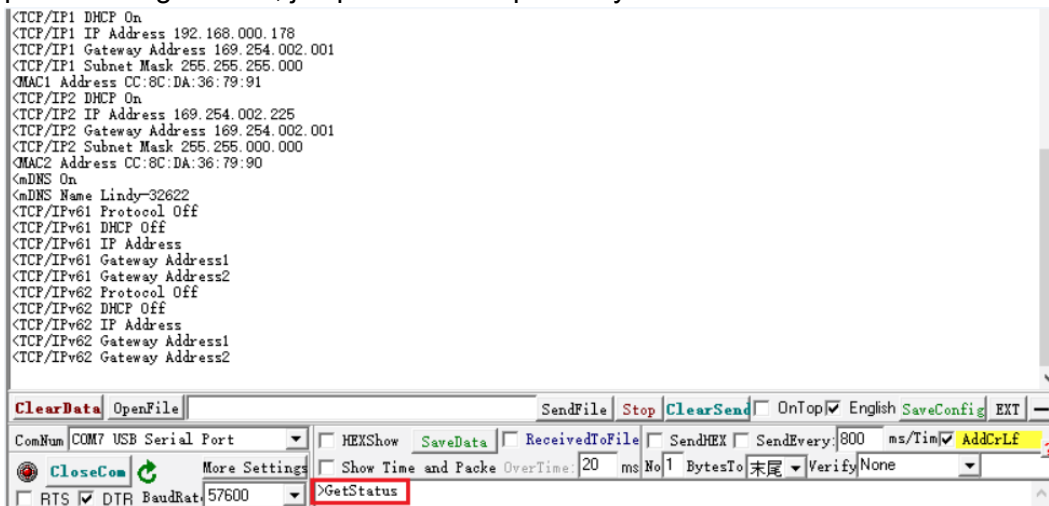

Jeśli w sieci nie ma serwera DHCP, takiego jak router, urządzenie powróci do następujących domyślnych ustawień IP:

Port 1: 192.168.0.178

Port 2: 169.254.2.225

Maska podsieci 1: 255.255.255.0

Maska podsieci 2: 255.255.0.0

Brama: 192.168.0.1

Port Telnet: 4001

Wpisz adres IP w przeglądarce, aby otworzyć stronę logowania.

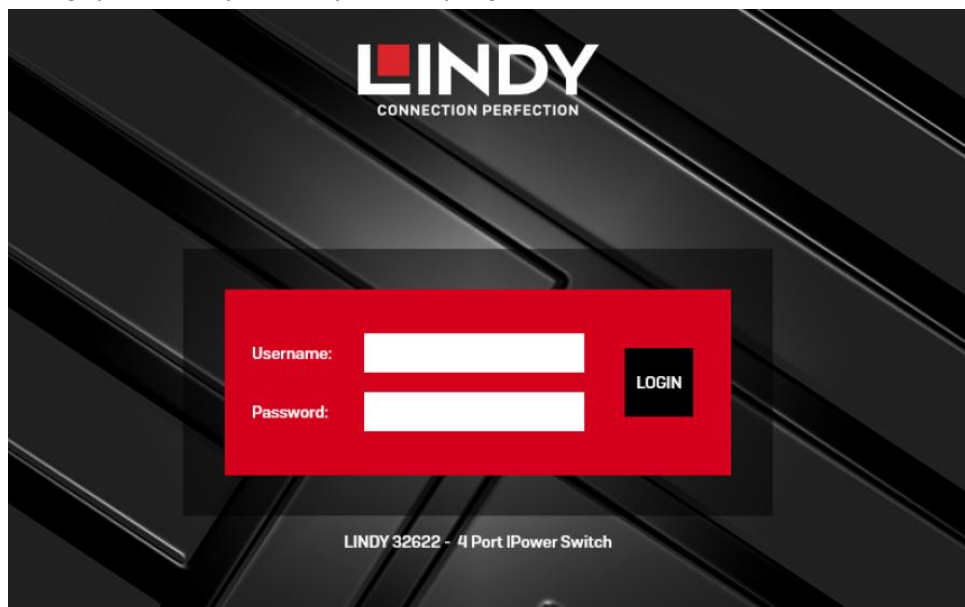

Domyślna nazwa użytkownika: admin

Domyślne hasło: aP?y43Tq

Wpisz domyślną nazwę użytkownika i hasło, a następnie kliknij **LOGIN**.

Ważne: Natychmiast zmień domyślne hasło

Aby chronić swój produkt i dane osobowe, należy jak najszybciej po konfiguracji zmienić domyślne hasło. Ten produkt jest zgodny z brytyjskim rozporządzeniem w sprawie bezpieczeństwa produktów i infrastruktury telekomunikacyjnej (PSTI), które wymaga, aby wszystkie domyślne hasła były unikalne lub generowane dla każdego urządzenia. Jednak aby zachować najwyższy poziom bezpieczeństwa, konieczne jest ustawienie własnego, silnego i łatwego do zapamiętania hasła.

Jak zmienić hasło:

1. Włącz urządzenie i połącz się z nim za pomocą interfejsu internetowego.
2. Zaloguj się przy użyciu domyślnych danych uwierzytelniających podanych powyżej.
3. Przejdź do sekcji **Security > Web-GUI login pass**.
4. Wprowadź nowe hasło i potwierdź.
5. Zapisz zmiany i zaloguj się ponownie, używając nowego hasła.

Wskazówki dotyczące tworzenia silnego hasła:

- Użyj co najmniej 8 znaków (zalecamy 12+)
- Użyj wielkich i małych liter
- Dodaj cyfry i znaki specjalne (!, @, # itp.)
- Unikaj popularnych słów i danych osobowych

Niezmienienie domyślnego hasła może narazić urządzenie na zagrożenia bezpieczeństwa. Jeśli potrzebujesz pomocy, skontaktuj się z naszym zespołem obsługi klienta.

Dashboard

The dashboard features a top navigation bar with tabs: Dashboard (active), Network, Schedule, Protocols, Email, Clock, System, and Security. The main content area is divided into several sections:

- Control Panel:** Includes buttons for 'ALL ON' (green), 'ALL OFF' (red), 'SYSTEM RESTART', and 'ALL METERS RESET'.
- Summary Metrics:** Displays 'Total Current' (9.9 A) and 'Total Power' (2400.0 W). Below this, 'Total Energy Consumed' is shown as 999999.9 kWh. 'Voltage' is 240 V. 'Frequency' is 50 Hz and 'Power Factor' is 0.8. A note indicates 'Energy measured since: 2023-5-1 12:34'.
- Outlet Management:** Four outlets (OUTLET 1-4) are shown, each with a status indicator (RS, ON/OFF) and a 'Settings' button. Each outlet displays 'Current' (9.9 A) and 'Power' (2400.0 W). Below each outlet is a table:

Vo.	PF	Energy Consumed
240V	0.75	999999.9 kWh
- Settings for OUTLET 1:** A detailed configuration panel for the first outlet, including:
 - Outlet Label: Outlet 1 (with a character limit of <= 10 Chars)
 - Outlet Re-Power Delay: [] seconds
 - Outlet Power-Off Delay: [] seconds
 - Meters Reset Duration: [] seconds
 - A 'Save Changes' button.

The bottom status bar shows: System Time: 2024-12-11 11:59, Uptime: 90days 12 hrs 59 mins, GUI Version: 1.0.0.1, System auto logout in 15mins, Maintenance, and Logout buttons.

- **ALL ON/ALL OFF:** włączenie/wyłączenie wszystkich 4 gniazdek.
- **SYSTEM RESTART:** restart urządzenia.
- **ALL METERS RESET:** reset mierników 4 gniazdek.
- **OUTLET 1-2-3-4**
 - RS:** reset zużycia energii.
 - ON/OFF:** włącz/wyłącz zasilanie.
 - Settings:** zmień nazwę gniazda, ustaw opóźnienia ponownego włączenia i wyłączenia zasilania oraz

czas trwania resetowania liczników.

Save Changes: kliknij, aby zapisać ustawienia gniazda.

Network

Dashboard Network Schedule Protocols Email Clock System Security

TCP/IP 1 Settings

Enable TCP/IP 1 ON OFF

Use IPv4 DHCP Yes Use Static IP

MAC Address: 2A:3B:4C:5D:6E:7F

IPv4 Address: 192.168.3.2

IPv4 Netmask: 255.255.0.0

IPv4 Gateway: 192.168.3.0

IPv4 DNS: 8.8.8.8

[Save Changes](#)

TCP/IP 2 Settings

Enable TCP/IP 2 ON OFF

Use IPv4 DHCP Yes Use Static IP

MAC Address: 2A:3B:4C:5D:6E:7F

IPv4 Address: 192.168.3.2

IPv4 Netmask: 255.255.0.0

IPv4 Gateway: 192.168.3.0

IPv4 DNS: 8.8.8.8

[Save Changes](#)

IPv6 Settings

Ethernet TCP/IP 1 TCP/IP 2

Use IPv6 Protocol Yes No

Use IPv6 Router Advertisement Yes No

IPv6 Settings DHCP v6 Manual

IPv6 Addresses: /64

IPv6 DNS Address 1:

IPv6 DNS Address 2:

IPv6 Gateway Address 1:

IPv6 Gateway Address 2:

[Save Changes](#)

Reply ICMP PING Yes No

HTTP Server HTTP ONLY HTTPS ONLY

HTTP Server Port:

HTTPS Server Port:

TLS Versions:

[Save Changes](#)

mDNS Yes No

Hostname:

[Save Changes](#)

System Time: 2024-12-11 11:59 Uptime: 90days 12 hrs 59 mins GUI Version: 1.0.0.1 System auto logout in 15mins Maintenance Logout

Ustawienia sieciowe, IPv4 i IPv6 dla obu portów TCP/IP, włączenie/wyłączenie funkcji PING, serwer HTTP i mDNS.

Schedule

Dashboard Network Schedule Protocols Email Clock System Security

Schedule Settings

Schedule Timer for: ALL OUTLETS

ALL OUTLETS
OUTLET 1
OUTLET 2
OUTLET 3
OUTLET 4

Turn ON All Time Turn ON All Time Turn OFF All Time

Turn ON All Time Turn ON All Time Turn OFF All Time

Please click below numbers to set the whole column to 'ON' or 'OFF'

Date/Hour	0	1	2	3	4	5	6	7	8	9	10	11	12	13	14	15	16	17	18	19	20	21	22	23
MON ▶																								
TUE ▶																								
WED ▶																								
THU ▶																								
FRI ▶																								
SAT ▶																								
SUN ▶																								

Please click above week days to set the whole row to 'ON' or 'OFF'.

Please click above little squares to set schedule individually, once save changes, new schedule will be activated from next planning hour or after system reboot.

Green box: Power ON
Red box: Power OFF

[Save Changes](#)

这两个按钮涉及开关，所以用不同的按钮颜色方式，填充色块为选中，字体颜色为normal状态

System Time: 2024-12-11 11:59 Uptime: 90days 12 hrs 59 mins GUI Version: 1.0.0.1 System auto logout in 15mins Maintenance Logout

Wybierz gniazda i zaplanuj stan włączenia/wyłączenia według dni i godzin (zielony oznacza włączony, czerwony oznacza wyłączony).

Protocols

Dashboard	Network	Schedule	Protocols	Email	Clock	System	Security																																																												
<table border="1"><thead><tr><th>SNMP</th><th>Telnet</th><th>MQTT</th><th>SSH</th><th>Modbus TCP</th></tr></thead><tbody><tr><td colspan="5">Enable SNMP V1 Options <input type="checkbox"/> SNMP GET <input checked="" type="checkbox"/> SNMP SET</td></tr><tr><td colspan="5">SNMP UDP Port <input type="text"/></td></tr><tr><td colspan="5">sysContact <input type="text"/></td></tr><tr><td colspan="5">sysName <input type="text"/></td></tr><tr><td colspan="5">sysLocation <input type="text"/></td></tr><tr><td colspan="5">Enable SNMP V2C <input type="radio"/> Yes <input checked="" type="radio"/> No</td></tr><tr><td colspan="5">Enable SNMP V3 <input type="radio"/> Yes <input checked="" type="radio"/> No</td></tr><tr><td colspan="5">Enable SNMP Trap <input checked="" type="radio"/> V1 Trap <input type="radio"/> V2C Trap <input type="radio"/> V3 Trap <input type="radio"/> Disable SNMP Trap</td></tr><tr><td colspan="5">SNMP Trap Receiver 1 <input type="text" value="prtg.mysite.org"/></td></tr><tr><td colspan="5">SNMP Trap Receiver 2 <input type="text" value="nagios.mysite.org"/></td></tr><tr><td colspan="5"><input type="button" value="Save Changes"/> <input type="button" value="Download MIB"/></td></tr></tbody></table>								SNMP	Telnet	MQTT	SSH	Modbus TCP	Enable SNMP V1 Options <input type="checkbox"/> SNMP GET <input checked="" type="checkbox"/> SNMP SET					SNMP UDP Port <input type="text"/>					sysContact <input type="text"/>					sysName <input type="text"/>					sysLocation <input type="text"/>					Enable SNMP V2C <input type="radio"/> Yes <input checked="" type="radio"/> No					Enable SNMP V3 <input type="radio"/> Yes <input checked="" type="radio"/> No					Enable SNMP Trap <input checked="" type="radio"/> V1 Trap <input type="radio"/> V2C Trap <input type="radio"/> V3 Trap <input type="radio"/> Disable SNMP Trap					SNMP Trap Receiver 1 <input type="text" value="prtg.mysite.org"/>					SNMP Trap Receiver 2 <input type="text" value="nagios.mysite.org"/>					<input type="button" value="Save Changes"/> <input type="button" value="Download MIB"/>				
SNMP	Telnet	MQTT	SSH	Modbus TCP																																																															
Enable SNMP V1 Options <input type="checkbox"/> SNMP GET <input checked="" type="checkbox"/> SNMP SET																																																																			
SNMP UDP Port <input type="text"/>																																																																			
sysContact <input type="text"/>																																																																			
sysName <input type="text"/>																																																																			
sysLocation <input type="text"/>																																																																			
Enable SNMP V2C <input type="radio"/> Yes <input checked="" type="radio"/> No																																																																			
Enable SNMP V3 <input type="radio"/> Yes <input checked="" type="radio"/> No																																																																			
Enable SNMP Trap <input checked="" type="radio"/> V1 Trap <input type="radio"/> V2C Trap <input type="radio"/> V3 Trap <input type="radio"/> Disable SNMP Trap																																																																			
SNMP Trap Receiver 1 <input type="text" value="prtg.mysite.org"/>																																																																			
SNMP Trap Receiver 2 <input type="text" value="nagios.mysite.org"/>																																																																			
<input type="button" value="Save Changes"/> <input type="button" value="Download MIB"/>																																																																			
System Time: 2024-12-11 11:59 Uptime: 90days 12 hrs 59 mins GUI Version: 1.0.0.1 System auto logout in 15mins <input type="button" value="Maintenance"/> <input type="button" value="Logout"/>																																																																			

Wybierz protokoły dostępne spośród SNMP, Telnet, MQTT, SSH i Modbus TCP, aby ustanowić wymagane połączenie. Każde okno zawiera konfigurację wybranego protokołu.

Email

Dashboard	Network	Schedule	Protocols	Email	Clock	System	Security																										
<table border="1"><thead><tr><th>SMTP Settings</th><th>Email Testing</th></tr></thead><tbody><tr><td>SMTP Server <input type="text" value="smtp.gmail.com"/></td><td>SMTP Setting must be completed before email testing.</td></tr><tr><td>SMTP Server Port <input type="text" value="587"/></td><td>To Recipients <input type="text"/></td></tr><tr><td>Connection Encryption <input type="text" value="STARTTLS"/> NONE SSL/TLS STARTTLS</td><td>Seperate by ',' to send multiple recipients, for example: user1@email.com,user2@email.com</td></tr><tr><td>Enable SMTP Authentication <input checked="" type="radio"/> Yes <input type="radio"/> No</td><td>From Sender <input type="text"/></td></tr><tr><td>Username <input type="text"/></td><td>Fill in custom email sender address, leave blank by using default address</td></tr><tr><td>Password <input type="password"/></td><td><input type="button" value="Send"/></td></tr><tr><td>Repeat Password <input type="password"/></td><td>Custom Email Content</td></tr><tr><td>Default Sender Name <input type="text"/></td><td>Email Topic <input type="text" value="Power Updates"/></td></tr><tr><td>Send System Daily Reports <input checked="" type="radio"/> Yes <input type="radio"/> No</td><td>Using system default topic when custom topic is no set.</td></tr><tr><td>Report send only when alarm happens if not tick Yes.</td><td>To Recipients <input type="text"/></td></tr><tr><td>Daily Report Time <input type="text" value="11:59"/> AM <input type="text" value="AM"/> (hh:mm)</td><td>Seperate by ',' to send multiple recipients, for example: user1@email.com,user2@email.com</td></tr><tr><td><input type="button" value="Save Changes"/></td><td><input type="button" value="Save Changes"/></td></tr></tbody></table>								SMTP Settings	Email Testing	SMTP Server <input type="text" value="smtp.gmail.com"/>	SMTP Setting must be completed before email testing.	SMTP Server Port <input type="text" value="587"/>	To Recipients <input type="text"/>	Connection Encryption <input type="text" value="STARTTLS"/> NONE SSL/TLS STARTTLS	Seperate by ',' to send multiple recipients, for example: user1@email.com,user2@email.com	Enable SMTP Authentication <input checked="" type="radio"/> Yes <input type="radio"/> No	From Sender <input type="text"/>	Username <input type="text"/>	Fill in custom email sender address, leave blank by using default address	Password <input type="password"/>	<input type="button" value="Send"/>	Repeat Password <input type="password"/>	Custom Email Content	Default Sender Name <input type="text"/>	Email Topic <input type="text" value="Power Updates"/>	Send System Daily Reports <input checked="" type="radio"/> Yes <input type="radio"/> No	Using system default topic when custom topic is no set.	Report send only when alarm happens if not tick Yes.	To Recipients <input type="text"/>	Daily Report Time <input type="text" value="11:59"/> AM <input type="text" value="AM"/> (hh:mm)	Seperate by ',' to send multiple recipients, for example: user1@email.com,user2@email.com	<input type="button" value="Save Changes"/>	<input type="button" value="Save Changes"/>
SMTP Settings	Email Testing																																
SMTP Server <input type="text" value="smtp.gmail.com"/>	SMTP Setting must be completed before email testing.																																
SMTP Server Port <input type="text" value="587"/>	To Recipients <input type="text"/>																																
Connection Encryption <input type="text" value="STARTTLS"/> NONE SSL/TLS STARTTLS	Seperate by ',' to send multiple recipients, for example: user1@email.com,user2@email.com																																
Enable SMTP Authentication <input checked="" type="radio"/> Yes <input type="radio"/> No	From Sender <input type="text"/>																																
Username <input type="text"/>	Fill in custom email sender address, leave blank by using default address																																
Password <input type="password"/>	<input type="button" value="Send"/>																																
Repeat Password <input type="password"/>	Custom Email Content																																
Default Sender Name <input type="text"/>	Email Topic <input type="text" value="Power Updates"/>																																
Send System Daily Reports <input checked="" type="radio"/> Yes <input type="radio"/> No	Using system default topic when custom topic is no set.																																
Report send only when alarm happens if not tick Yes.	To Recipients <input type="text"/>																																
Daily Report Time <input type="text" value="11:59"/> AM <input type="text" value="AM"/> (hh:mm)	Seperate by ',' to send multiple recipients, for example: user1@email.com,user2@email.com																																
<input type="button" value="Save Changes"/>	<input type="button" value="Save Changes"/>																																
System Time: 2024-12-11 11:59 Uptime: 90days 12 hrs 59 mins GUI Version: 1.0.0.1 System auto logout in 15mins <input type="button" value="Maintenance"/> <input type="button" value="Logout"/>																																	

Skonfiguruj serwer poczty e-mail i konto, aby otrzymywać ostrzeżenia i raporty.

Clock

Dashboard	Network	Schedule	Protocols	Email	Clock	System	Security
<div><h3>NTP Settings</h3><p>Enable NTP Server <input checked="" type="radio"/> Yes <input type="radio"/> No</p><p>Primary NTP Server <input type="text" value="0.pool.ntp.org"/></p><p>Secondary NTP Server <input type="text" value="1.pool.ntp.org"/></p><p>Timezone <input type="text" value="(GMT-05:00) Eastern Time (US & Canada), Bogota, Lima, Quito"/></p><p>Daylight Saving Time (DST) <input type="radio"/> Yes <input checked="" type="radio"/> No</p><p>Clock Format <input checked="" type="radio"/> 12-hour <input type="radio"/> 24-hour</p><p>Save Changes</p></div> <div><h3>Manual Settings</h3><p>Set Date Manually <input type="text" value="2024-11-01"/> (yyyy-mm-dd)</p><p>Set Time Manually <input type="text" value="11:59"/> <input type="text" value="AM"/> (hh:mm)</p><p>Clock Format <input type="radio"/> 12-hour <input type="radio"/> 24-hour</p><p>Save Changes</p></div>							
System Time: 2024-12-11 11:59 Uptime: 90days 12 hrs 59 mins GUI Version: 1.0.0.1 System auto logout in 15mins Maintenance Logout							

Skonfiguruj ustawienia czasu ręcznie lub przez połączenie internetowe, włączając serwer NTP.

System

Dashboard	Network	Schedule	Protocols	Email	Clock	System	Security
<div><h3>System Settings</h3><p>Front Panel Lock <input checked="" type="radio"/> Yes <input type="radio"/> No</p><hr/><p>Device Name <input type="text"/></p><p>Login Timeout <input type="text" value="15"/> min (Default: 15mins)</p><p>Warning Beeper Time <input type="text" value="10"/> s (Default: 10s)</p><p>Standby Mode <input checked="" type="radio"/> Standby Mode <input type="radio"/> Sleep Mode</p><p>Save Changes</p><hr/><p>Overload Processing <input checked="" type="radio"/> Power off the overloaded outlet</p><p><input type="radio"/> Power off all outlets, then system standby</p><p><input type="radio"/> Auto recover <input type="text" value="3"/> retries, in <input type="text" value="3"/> mins (1-10, Default 3)</p><p>Overcurrent Threshold <input type="text" value="10.9"/> A (Max. 10.9A)</p><p>Save Changes</p></div>							
System Time: 2024-12-11 11:59 Uptime: 90days 12 hrs 59 mins GUI Version: 1.0.0.1 System auto logout in 15mins Maintenance Logout							

Strona ustawień systemowych, odblokowanie przycisków na panelu przednim, limit czasu logowania, czas sygnału ostrzegawczego, przetwarzanie przeciążenia i próg przetężenia..

Security

Navigation: Dashboard | Network | Schedule | Protocols | Email | Clock | System | **Security**

Security Settings

Web-GUI Login

Password:

RADIUS

Enable Radius Client: Yes No

Authentication Protocol: PAP CHAP

Use Message Authentication: Yes No

Default Session Timeout: seconds

Primary Server:

New Shared Password:

Repeat Password:

Timeout:

Retries:

System Time: 2024-12-11 11:59 | Uptime: 90days 12 hrs 59 mins | GUI Version: 1.0.0.1 | System auto logout in 15mins | |

Ustawienia bezpieczeństwa, zmiana hasła logowania i parametrów klienta radius.

Maintenance

Maintenance

System Logs

04-12-2023 23:59:59 Critical Outlet-3 Overvoltage	<input type="button" value="View Log File"/> <input type="button" value="Clear Log File"/> <input type="button" value="Export Log File"/>
04-12-2023 23:59:59 Normal Outlet-1 Power On	
04-12-2023 23:59:59 Critical Outlet-2 Overcurrent	
04-12-2023 23:59:59 Normal Outlet-4 Power Off	
04-12-2023 23:59:59 Normal Outlet- 1 Power On	
04-12-2023 23:59:59 Normal Outlet-2 Reset Meter	
04-12-2023 23:59:59 Normal Outlet-3 Reset Meter	
04-12-2023 23:59:59 Normal Outlet- 4 Power Off	
04-12-2023 23:59:59 Normal Outlet- 1 Power On	
04-12-2023 23:59:59 Normal Outlet- 1 Power On	

Firmware Update

Current Firmware version: 1.1.1.1

SSL Certificate Upload

Config Import

Config Export

Kliknij przycisk Konserwacja, aby wyświetlić dzienniki systemu, aktualizacje oprogramowania układowego, przesłać certyfikat SSL, zaimportować i wyeksportować konfigurację, zrestartować urządzenie, przywrócić ustawienia fabryczne i wyczyścić pamięć podręczną DNS.

Polecenia

Adres IP portu 1: 192.168.0.178

Adres IP portu 2: 169.254.2.225

Port Telnet: 4001

Szybkość transmisji: 57600 (domyślna)

Bit danych: 8

Bit stopu: 1

Bit kontrolny: brak

Terminator: <CR><LF>

Kod zwrotny błędu polecenia: <Command Error <Out of Range

Command	Function	Example	Feedback
>?/Help	List all the command	>? >Help	All the commands list
>GetStatus	Check the status of the device.	>GetStatus	<Lindy-32622 <V1.0.0a <GetPowerStatus On <GetKeyStatus On <GetTCP/IPEnable 1 <GetRS232Baud 57600 <GetSystemCurrentThreshold 10.9A <Outlet 1 Off <Outlet 2 Off <Outlet 3 Off <Outlet 4 Off <GetGroundStatus Properly Grounded <GetOutletMode 1 Idle <GetOutletMode 2 Idle <GetOutletMode 3 Idle <GetOutletMode 4 Idle <GetOutletPowerOnTime 1 1s <GetOutletPowerOnTime 2 2s <GetOutletPowerOnTime 3 3s <GetOutletPowerOnTime 4 4s <GetOutletPowerOffTime 1 1s <GetOutletPowerOffTime 2 2s <GetOutletPowerOffTime 3 3s <GetOutletPowerOffTime 4 4s <GetOutletEleResetTime 1 10s <GetOutletEleResetTime 2 10s <GetOutletEleResetTime 3 10s <GetOutletEleResetTime 4 10s <GetSafeMode Outlet_Shutdown <GetStandbyMode All_Standby_Mode <GetOverloadRetryCnt 1 <GetOverloadRetryTime 3mins

			<pre> <GetBeeperTime 10s <TCP/IP1 DHCP Off <TCP/IP1 IP Address 169.254.000.178 <TCP/IP1 Gateway Address <TCP/IP1 Subnet Mask 255.255.000.000 <MAC1 Address CC:8C:DA:00:00:00 <TCP/IP2 DHCP Off <TCP/IP2 IP Address 192.168.000.200 <TCP/IP2 Gateway Address 192.168.000.001 <TCP/IP2 Subnet Mask 255.255.255.000 <MAC2 Address CC:8C:DA:00:00:00 <mDNS Off <mDNS Name Lindy-32622 <TCP/IPv61 Protocol Off <TCP/IPv61 DHCP Off <TCP/IPv61 IP Address <TCP/IPv61 Gateway Address1 <TCP/IPv61 Gateway Address2 <TCP/IPv62 Protocol Off <TCP/IPv62 DHCP Off <TCP/IPv62 IP Address <TCP/IPv62 Gateway Address1 <TCP/IPv62 Gateway Address2 </pre>
>GETOUTLETSTATUS	Check the status of a single outlet. >GETOUTLETSTATUS [Param1] [Param1] = 0-4	>GETOUTLETSTATUS 1	<Outlet 1 On
>GetElesta	Check the electricity information, such as power consumption, voltage, current, etc.	>GetElesta	<pre> < Lindy-32622 <V1.0.0a <Total Current 0.000A <Total Power 0.000W <Total Energy Consumed 0.000000kWh <Voltage 232.199V <Frequency 49.54Hz <Power Factor 0.00 <GetOutletVoltage 1 0.000V <GetOutletVoltage 2 0.000V <GetOutletVoltage 3 0.000V <GetOutletVoltage 4 0.000V <GetOutletCurrent 1 0.000A <GetOutletCurrent 2 0.000A <GetOutletCurrent 3 0.000A <GetOutletCurrent 4 0.000A <GetOutletPower 1 0.000W <GetOutletPower 2 0.000W <GetOutletPower 3 0.000W <GetOutletPower 4 0.000W <GetOutletConsumed 1 0.000000kWh <GetOutletConsumed 2 </pre>

			0.000000kWh <GetOutletConsumed 3 0.000000kWh <GetOutletConsumed 4 0.000000kWh <GetOutletPowerFactor 1 0.00 <GetOutletPowerFactor 2 0.00 <GetOutletPowerFactor 3 0.00 <GetOutletPowerFactor 4 0.00
>GetFwVersion	Check the firmware version.	>GetFwVersion	<FW VersiOn: V1.0.0a <GUI VersiOn: V1.0.0a
>SetDeviceName	Set a nickname for the device. >SetDeviceName: [Param1] [Param1] should be the nickname you want to set. (14 characters maximum)	>SetDeviceName: Lindy-32622	<Device Name: Lindy-32622
>SetPower	Enter/Exit the standby mode. >SetPower [Param1] [Param1] = On,Off On - Power on Off - Power off	>SetPower On >SetPower Off	<System Power Off <System Power On, Please Wait A Moment... Done
>SetKeyLock	To lock/unlock the button on the front panel of the device. >SetKeyLock [Param1] [Param1] = On,Off On-GetKeyStatus Off Off- GetKeyStatus On	>SetKeyLock On >SetKeyLock Off	<KeyLock On <KeyLock Off
>SetCurrentThreshold	Set a current threshold for the system. >SetCurrentThreshold [Param1] [Param1] = 0.0-10.9	>SetCurrentThreshold 10	<System Current Threshold 10.0A
>SetVoltageThreshold	Set a voltage threshold for the system. >SetVoltageThreshold [Param1] [Param1] =198-264	>SetVoltageThreshold 264	<System Voltage Threshold 264V
>SetSafeMode	Set an action of what the system will do when it goes overloaded. >SetSafeMode [Param1] [Param1] = 0-2 0: Outlet_Shutdown 1: System_Shutdown 2:Auto_Retry	>SetSafeMode 0 >SetSafeMode 1 >SetSafeMode 2	<System Safe Mode: Outlet_Shutdown <System Safe Mode: System_Shutdown <System Safe Mode: Auto_Retry
>SetOverloadRetryCnt	Set how many time the system will reboot when it goes overloaded. >SetOverloadRetryCnt [Param1] [Param1] = 1-3 1(Default)	>SetOverloadRetryCnt 1 >SetOverloadRetryCnt 2 >SetOverloadRetryCnt 3	<System Retry Number 1 <System Retry Number 2 <System Retry Number 3
>SetOverloadRetryTime	Set a delayed time for the system to reboot when it goes overloaded. (unit is minutes) >SetOverloadRetryTime [Param1] [Param1] = 1-10 3(Default)	>SetOverloadRetryTime 1	<System Retry Delay Time 1mins
>SetStandbyMode	Set a standby mode for the system. >StandbyMode [Param1] [Param1] = 0-1 0: All_Standby_Mode (GUI is not responsive) 1: Sleep_Mode (GUI is responsive, no data exchange with MCU)	>SetStandbyMode 0 >SetStandbyMode 1	<System Standby Mode: All_Standby_Mode <System Standby Mode: Sleep_Mode

>SetRs232Baud	Set a baudrate for RS232 >SetRs232Baud [Param1] [Param1] = 1-7 1: 2400 2: 4800 3: 9600 4: 19200 5: 38400 6: 57600(Default), 7: 115200	>SetRs232Baud 6	<RS232Baud 57600
>SetRs232Out	RS232 Passthrough >SetRs232Out [Param1][Param2][Param3][Param4]] [Param1] = a,h a: ASCII h: HEX [Param2] = 1-7 1: 2400 2: 4800 3: 9600 4: 19200 5: 38400 6: 57600 (Default) 7: 115200 [Param3] = 1-3 1: None 2: Even 3: Odd Param4 = string	>SETR232OUT a:6:1:RS232	RS232
>SetBeeperTime	Set buzzer duration of time. (unit is seconds) >SetBeeperTime [Param1] [Param1] = 0: 9999 10(Default)	>SetBeeperTime 10	<Buzzer Sound Time 10s
>SetOutletTime	Set a dealy time for an outlet to turn on/off. (unit is seconds) >SetOutlet[Param1]Time [Param2][Param3] [Param1] = On,Off [Param2] = 1-4 1: Outlet1 2: Outlet2 3: Outlet3 4: Outlet4 [Param3] = 2-9999 (On)/ 0-9999 (Off)	>SetOutletOnTime 1:1 >SetOutletOffTime 1:1	<Outlet 1 Power_On Delay 1s <Outlet 1 Power_Off Delay 1s
>SetOutletEleResetTime	Set a delay time to reset the values of a specific outlet on GUI. >SetOutletEleResetTime[Param1][Param2] [Param1] = 1-4 1: Outlet1 2: Outlet2 3: Outlet3 4: Outlet4 [Param2] = 0-9999 10(Default)	>SetOutletEleResetTime 1:10	<Outlet 1 Electrical Work Reset Duration 10s
>SetAllOut	Turn on/off all the outlets. >SetAllOut [Param1] [Param1] = On,Off	>SetAllOut On >SetAllOut Off	<All Outlets On <All Outlets Off

>SetOutlet	Turn on/off a single outlet. >SetOutlet [Param1][Param2] [Param1] = 1-4 1: Outlet1 2: Outlet2 3: Outlet3 4: Outlet4 [Param2] = On,Off	>SetOutlet 1 On	<Outlet 1 On
>RsAllOutEle	Reset the metered values displayed on the GUI for all outlets.	>RsAllOutEle	<Clean Up Electrical Work: All Outlets
>RsOutEle	Reset the metered values displayed on the GUI for a specific outlet. >RsOutEle [Param1] [Param1] = 1-4 1: Outlet1 2: Outlet2 3: Outlet3 4: Outlet4	>RsOutEle 1	<Clean Up Electrical Work: Outlet 1
>GetSysTime	Get the time of the date and time of the system.	>GetSysTime	<GetSystemTime: 2023-05-11 02:47:16 Thu
>SetSysTime	Set the date and time for the device: >SetSysTime [Param1] [Param1] = year-month-day;hour-minutes-seconds	>SetSysTime 2025-03-18;11-26-59	<SetSystemTime: 2025-03-18 11:26:59
>SetNetTcp/IpEnable	Enable/Disable the TCP/IP: >SetNetTcp/IpEnable [Param1] [Param1] = 1-2 1: TCP/IP1 2: TCP/IP2	>SetNetTcp/IpEnable 1 >SetNetTcp/IpEnable 2	<TCP/IP1 Enable <TCP/IP2 Enable
>SetNetTcp/Ip1Dhcp	Turn on/off the DHCP for TCP/IP1: >SetNetTcp/Ip1Dhcp [Param1] [Param1] = On,Off	>SetNetTcp/Ip1Dhcp On >SetNetTcp/Ip1Dhcp Off	<TCP/IP1 DHCP On <TCP/IP1 DHCP Off
>SetNetTcp/Ip1Ip	Set an IP address for TCP/IP1: >SetNetTcp/Ip1Ip [Param1] [Param1] = XXX.XXX.XXX.XXX	>SetNetTcp/Ip1Ip 192.168.000.001	<TCP/IP1 IP Address 192.168.000.001
>SetNetTcp/Ip1Gw	Set a gateway for TCP/IP1: >SetNetTcp/Ip1Gw [Param1] [Param1] = XXX.XXX.XXX.XXX	>SetNetTcp/Ip1Gw 192.168.000.254	<TCP/IP1 Gateway Address 192.168.000.254
>SetNetTcp/Ip1Sm	Set a subnet mask for TCP/IP1: >SetNetTcp/Ip1Sm [Param1] [Param1] = XXX.XXX.XXX.XXX	>SetNetTcp/Ip1Sm 192.168.000.254	<TCP/IP1 Subnet Mask 192.168.000.254
>SetNetTcp/Ip2Dhcp	Turn on/off the DHCP of TCP/IP2: >SetNetTcp/Ip2Dhcp [Param1] [Param1] = On,Off	>SetNetTcp/Ip2Dhcp On >SetNetTcp/Ip2Dhcp Off	<TCP/IP2 DHCP On <TCP/IP2 DHCP Off
>SetNetTcp/Ip2Ip	Set an IP address for TCP/IP2: >SetNetTcp/Ip2Ip [Param1] [Param1] = XXX.XXX.XXX.XXX	>SetNetTcp/Ip2Ip 192.168.000.001	<TCP/IP2 IP Address 192.168.000.001
>SetNetTcp/Ip2Gw	Set the gateway for TCP/IP2: >SetNetTcp/Ip2Gw [Param1] [Param1] = XXX.XXX.XXX.XXX	>SetNetTcp/Ip2Gw 192.168.000.254	<TCP/IP2 Gateway Address 192.168.000.254
>SetNetTcp/Ip2Sm	Set the subnet mask for TCP/IP2 >SetNetTcp/Ip2Sm [Param1] [Param1]	>SetNetTcp/Ip2Sm 192.168.000.254	<TCP/IP2 Subnet Mask 192.168.000.254
>SetNetMdns	Turn on/off the mDNS >SetNetMdns [Param1] [Param1] = On,Off	>SetNetMdns On >SetNetMdns Off	<mDNS On <mDNS Off
>SetNetRb	Reboot the IP service	>SetNetRb	<Network Reboot And Apply New Config
>SetNetTcp/Ipv61Protocol	Turn on/off the TCP/IPv6 Protocol >SetNetTcp/Ipv61Protocol [Param1] [Param1] = On,Off	>SetNetTcp/Ipv61Protocol On	<TCP/IPv6 1 Protocol On <TCP/IPv6 1 Protocol Off

		>SetNetTcp/Ipv61Protocol Off	
>SetNetTcp/Ipv61Dhcp	Turn on/off the DHCP for TCP/IPv61 >SetNetTcp/Ipv61Dhcp [Param1] [Param1] = On,Off	>SetNetTcp/Ipv61Dhcp On >SetNetTcp/Ipv61Dhcp Off	<TCP/IPv6 1 DHCP On <TCP/IPv6 1 DHCP Off
>SetNetTcp/Ipv61Ip	Set an IP address for TCP/IPv61 >SetNetTcp/Ipv61Ip [Param1] [Param1] = XXX.XXX.XXX.XXX	>SetNetTcp/Ipv61Ip 192.168.000.001	<TCP/IPv6 1 IP Address 192.168.000.001
>SetNetTcp/Ipv61Gw	Set the gateway for TCP/IPv6: >SetNetTcp/Ipv61Gw [Param1][Param2] [Param1] = 1-2 [Param2] = XXX.XXX.XXX.XXX	>SetNetTcp/Ipv61Gw 1 192.168.000.254 >SetNetTcp/Ipv61Gw 2 192.168.000.254	<TCP/IPv6 1 Gateway Address1 192.168.000.254 <TCP/IPv6 1 Gateway Address2 192.168.000.254
>SetNetTcp/Ipv62Protocol	Turn on/off TCP/IPv62 Protocol >SetNetTcp/Ipv62Protocol [Param1] [Param1] = On,Off	>SetNetTcp/Ipv62Protocol On >SetNetTcp/Ipv62Protocol Off	<TCP/IPv6 2 Protocol On <TCP/IPv6 2 Protocol Off
>SetNetTcp/Ipv62Dhcp	Turn on/off the TCP/IPv62 DHCP >SetNetTcp/Ipv62Dhcp [Param1] [Param1] = On,Off	>SetNetTcp/Ipv62Dhcp On >SetNetTcp/Ipv62Dhcp Off	<TCP/IPv6 2 DHCP On <TCP/IPv6 2 DHCP Off
>SetNetTcp/Ipv62Ip	Set an IP address for TCP/IPv62 >SetNetTcp/Ipv62Ip [Param1] [Param1] = XXX.XXX.XXX.XXX	>SetNetTcp/Ipv62Ip 192.168.000.001	<TCP/IPv6 2 IP Address 192.168.000.001
>SetNetTcp/Ipv62Gw	Set the gateway for TCP/IPv62: >SetNetTcp/Ipv62Gw [Param1][Param2] [Param1] = 1-2 [Param2] = XXX.XXX.XXX.XXX	>SetNetTcp/Ipv62Gw 1 192.168.000.254 >SetNetTcp/Ipv62Gw 2 192.168.000.254	<TCP/IPv6 2 Gateway Address1 192.168.000.254 <TCP/IPv6 2 Gateway Address2 192.168.000.254
>FactoryReset	Factory Reset the device.	>FactoryReset	<FactoryReset
>Reboot	Restart the MCU and GUI	>Reboot	<Reboot
>Resta	Restart MCU	>Resta	<System Restart

Lindy regularnie sprawdza i testuje naszą gamę produktów, aby zapewnić maksymalną kompatybilność i wydajność. Najbardziej aktualną wersję niniejszej instrukcji można znaleźć na lokalnej stronie internetowej Lindy, wyszukując odpowiedni numer części i znajdując instrukcję w sekcji Pliki do pobrania.

Recycling Information



WEEE (Waste of Electrical and Electronic Equipment), Recycling of Electronic Products

Europe, United Kingdom

In 2006 the European Union introduced regulations (WEEE) for the collection and recycling of all waste electrical and electronic equipment. It is no longer allowable to simply throw away electrical and electronic equipment. Instead, these products must enter the recycling process. Each individual EU member state, as well as the UK, has implemented the WEEE regulations into national law in slightly different ways. Please follow your national law when you want to dispose of any electrical or electronic products. More details can be obtained from your national WEEE recycling agency.

Battery Information

The following batteries or accumulators are included in this electrical appliance

Battery Quantity and Type	Chemical System
1x CR2032	Coin Cell Lithium Metal

Product and Identification

Product Name: Li-Mn Battery CR2032

Manufacturer: Panasonic

Address: Indonesia

Date of Manufacture:

Nominal Voltage	3V	Dimensions/QR code
Impedance	20Ω	
Typical weight	2.8g	
Typical Volume	1cm ³	
Terminals	Stainless steel / Ni plating	
Storage Temperature range	5°C~35°C	
Operating Temperature range	-30°C to 85°C	
Capacity	225mAh	
Minimum Average Operating Time	non-rechargeable portable batteries bear a label indicating their minimum average operating time when used in certain applications and a label stating " non-rechargeable ".	

COMPOSITION AND INGREDIENTS

The chemicals and metals in this product are contained in a sealed can. Exposure to the contents will not occur unless the battery leaks, is exposed to high temperatures or is mechanically, physically, or electrically abused.

Chemical Name	Approximate weight	CAS No	EC
As mentioned in the MSDS	≤0.3g	212400903128330	D240001

HAZARDS IDENTIFICATION

General Battery Safety

Your device uses disposable or rechargeable batteries. Misuse of these batteries can result in injury, death, property damage, or damage to your device or its accessories due to battery fluid leakage, fire, overheating, or explosion. Battery fluid is corrosive, toxic, and can cause burns or serious harm if ingested.

To Reduce the Risk of Injury:

- **Keep batteries out of reach of children.**
- **Use the correct charger:** Rechargeable batteries should only be charged with the charger provided or recommended for your device. Improper charging can result in fire or explosion.
- **Replace old or worn batteries promptly:** Dispose of them responsibly, following local regulations.
- **Remove batteries during long-term storage:** Store your device without batteries to avoid leakage.
- **Avoid contact with battery fluid:** If a battery leaks, ensure the fluid does not contact skin, eyes, or clothes. In case of contact, rinse thoroughly with water and seek medical advice if needed. Clean the battery compartment before inserting new batteries.

Recycling Information

HANDLING AND USAGE TIPS:

- Use only LINDY-approved battery packs or batteries of the same type and rating.
- Do not disassemble, crush, puncture, or expose batteries to temperatures above 40°C (104°F).
- Avoid mixing old and new batteries or different types (e.g., carbon-zinc and alkaline).
- Prevent metal objects from touching battery terminals to avoid burns.
- Do not immerse batteries in water or expose them to fire.
- Do not use a wet battery or attempt to dry it with heat sources like hair dryers or ovens.
- Handle batteries carefully to prevent physical damage or short circuits.
- Discard damaged batteries safely.

WARNING: Safety for Non-User-Replaceable Batteries

Improper handling of your device's non-removable battery can lead to fire or explosion:

- Do not heat, open, puncture, or dispose of the device or its battery in fire.
- Avoid charging the device in direct sunlight for extended periods.

For repairs, consult professionals. Attempting repairs can cause electric shock, device damage, or personal injury.

WARNING: Safety for User-Replaceable Batteries

If your device has a user-replaceable battery:

- Follow the instructions in the Quick Start Guide to replace the battery.
- Seek professional assistance for other repairs to avoid risks like electric shock or device damage.

WARNING: Coin Cell/Button Battery Safety

CHEMICAL BURN HAZARD. KEEP OUT OF REACH OF CHILDREN.

Swallowing coin/button batteries can cause severe internal injuries or death within hours. If you suspect ingestion or insertion, seek immediate medical attention. Always keep new and used batteries out of children's reach.

CAUTION: Batteries can explode or leak, causing burns if: recharged improperly, disposed of in fire, mixed with different battery types or inserted backward. Replace all batteries at the same time. Do not carry loose batteries or remove battery labels.

FIRST AID INFORMATION

Ingestion: Do not induce vomiting. Seek medical attention immediately.

Eye Contact: Flush with water for 15 minutes and seek medical help if irritation persists.

Skin Contact: Wash with soap and water. Seek medical attention if irritation continues.

Inhalation: Move to fresh air. Seek medical advice if symptoms persist.

FIRE FIGHTING MEASURES

Hazards During Combustion: Batteries can release toxic fumes like carbon monoxide and other harmful substances. Avoid inhalation.

Extinguishing Media: Use Class "D" fire extinguishers, lith-x, copper powder, or dry sand for battery fires. For adjacent fires involving packaged cells, water or CO₂ may be used. Avoid water for bulk unpacked cells. Firefighters should wear self-contained breathing apparatus.

HANDLING AND STORAGE

Precautions: Handle batteries carefully to avoid damage that could lead to short circuits, leakage, or explosions.

Storage: Keep batteries in a cool, dry, and well-ventilated area.

INSTRUCTIONS for Battery Use, Removal, and Replacement

Read specifications carefully before use. Improper handling of lithium batteries can lead to failure, including leakage, overheating, fire, or explosion. Follow all instructions for safe battery use, removal, and replacement to avoid injury or device damage.

Information on the safe removal of batteries or accumulators

The (rechargeable) battery cannot be removed from this device. Make sure it is completely drained before you hand the device to your collection system for waste electronic equipment.

Recycling Information

CR Coin Cell Battery Handling Precautions



Please note - CR Coin Cell batteries require careful handling to ensure safety and performance. **Non-rechargeable, do not attempt to charge.**



Do not disassemble - Tampering with batteries can result in leaks or injuries.



Do not swallow - Swallowing batteries is dangerous and requires immediate medical attention.



Do not puncture - Piercing batteries can cause dangerous leakage or explosions.



Keep away from children - Batteries can pose a choking hazard or risk of ingestion.



Do not solder directly - Applying heat directly to the battery can lead to damage or failure.



Keep away from fire and heat - Exposure to high temperatures can cause leakage, rupture, or explosions.



Do not mix old, new, or different types - Mixing batteries can affect performance and cause leakage.



Do not stack - Stacking batteries improperly can lead to instability and damage.



Do not charge - These batteries are non-rechargeable—do not attempt to recharge them



Avoid contact with metal items - Mixing batteries with metal objects can cause short circuits.



Store in original packaging - Batteries should be kept in their packaging to avoid contact with each other and prevent short circuits.



V1: 11/24

Germany / Deutschland Elektro- und Elektronikgeräte

Informationen für private Haushalte sowie gewerbliche Endverbraucher

Hersteller-Informationen gemäß § 18 Abs. 4 ElektroG (Deutschland)

Das Elektro- und Elektronikgerätegesetz (ElektroG) enthält eine Vielzahl von Anforderungen an den Umgang mit Elektro- und Elektronikgeräten. Die wichtigsten sind hier zusammengestellt.

1. Bedeutung des Symbols „durchgestrichene Mülltonne“



Das auf Elektro- und Elektronikgeräten regelmäßig abgebildete Symbol einer durchgestrichenen Mülltonne weist darauf hin, dass das jeweilige Gerät am Ende seiner Lebensdauer getrennt vom unsortierten Siedlungsabfall zu erfassen ist.

2. Getrennte Erfassung von Altgeräten

Elektro- und Elektronikgeräte, die zu Abfall geworden sind, werden als Altgeräte bezeichnet. Besitzer von Altgeräten haben diese einer vom unsortierten Siedlungsabfall getrennten Erfassung zuzuführen. Altgeräte gehören insbesondere nicht in den Hausmüll, sondern in spezielle Sammel- und Rückgabesysteme.

3. Batterien und Akkus sowie Lampen

Besitzer von Altgeräten haben Altbatterien und Altakkumulatoren, die nicht vom Altgerät umschlossen sind, sowie Lampen, die zerstörungsfrei aus dem Altgerät entnommen werden können, im Regelfall vor der Abgabe an einer Erfassungsstelle vom Altgerät zu trennen. Dies gilt nicht, soweit Altgeräte einer Vorbereitung zur Wiederverwendung unter Beteiligung eines öffentlich-rechtlichen Entsorgungsträgers zugeführt werden.

Informationen zur Batterie

Die folgenden Batterien oder Akkumulatoren sind in diesem Elektrogerät enthalten

Anzahl und Typ der Batterien	Chemisches System
1x CR2032	Coin Cell Lithium Metal

Produkt und Kennzeichnung

Produktname: Li-Mn-Batterie CR2032

Hersteller: Panasonic

Adresse: Indonesia

Datum der Herstellung:

Recycling Information

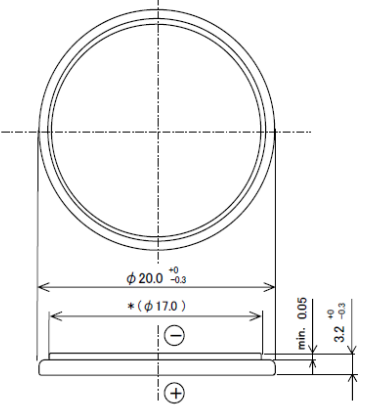
Nennspannung	3V	Dimensions/QR code 
Impedanz	20Ω	
Typisches Gewicht	2.8g	
Typisches Volumen	1cm ³	
Anschlussklemmen	Stainless steel / Ni plating	
Lagertemperaturbereich	5°C~35°C	
Betriebstemperaturbereich	-30°C to 85°C	
Kapazität	225mAh	
Minimale durchschnittliche Betriebsdauer	non-rechargeable portable batteries bear a label indicating their minimum average operating time when used in certain applications and a label stating "non-rechargeable".	

ZUSAMMENSETZUNG UND INHALTSSTOFFE

Die Chemikalien und Metalle in diesem Produkt sind in einer versiegelten Dose enthalten. Eine Exposition gegenüber dem Inhalt erfolgt nur dann, wenn die Batterie ausläuft, hohen Temperaturen ausgesetzt wird oder mechanisch, physisch oder elektrisch missbraucht wird.

Chemical Name	Approximate weight	CAS No	EC
As mentioned in the MSDS	≤0.3g	212400903128330	D240001

IDENTIFIZIERUNG VON GEFAHREN

Allgemeine Batteriesicherheit

Ihr Gerät verwendet Einwegbatterien oder wiederaufladbare Batterien. Die falsche Verwendung dieser Batterien kann zu Verletzungen, Tod, Sachschäden oder Schäden an Ihrem Gerät oder dessen Zubehör durch Auslaufen der Batterieflüssigkeit, Feuer, Überhitzung oder Explosion führen. Die Batterieflüssigkeit ist ätzend und giftig und kann bei Verschlucken zu Verbrennungen oder schweren Schäden führen.

So verringern Sie das Verletzungsrisiko:

- **Bewahren Sie die Batterien außerhalb der Reichweite von Kindern auf.**
- **Verwenden Sie das richtige Ladegerät:** Wiederaufladbare Batterien sollten nur mit dem mitgelieferten oder dem für Ihr Gerät empfohlenen Ladegerät aufgeladen werden. Unsachgemäßes Aufladen kann zu Bränden oder Explosionen führen.
- **Ersetzen Sie alte oder verbrauchte Akkus umgehend:** Entsorgen Sie sie verantwortungsbewusst und entsprechend den örtlichen Vorschriften.
- **Entfernen Sie die Batterien bei langfristiger Lagerung:** Lagern Sie Ihr Gerät ohne Batterien, um ein Auslaufen zu vermeiden.
- **Vermeiden Sie den Kontakt mit Batterieflüssigkeit:** Wenn eine Batterie ausläuft, achten Sie darauf, dass die Flüssigkeit nicht mit Haut, Augen oder Kleidung in Berührung kommt. Im Falle eines Kontakts spülen Sie das Gerät gründlich mit Wasser ab und suchen Sie gegebenenfalls einen Arzt auf. Reinigen Sie das Batteriefach, bevor Sie neue Batterien einlegen.

TIPPS ZUR HANDHABUNG UND VERWENDUNG:

- Verwenden Sie nur von LINDY zugelassene Akkus oder Akkus desselben Typs und derselben Leistung.
- Zerlegen Sie die Batterien nicht, zerdrücken Sie sie nicht, durchstechen Sie sie nicht und setzen Sie sie keinen Temperaturen über 40°C aus.
- Vermeiden Sie es, alte und neue Batterien oder verschiedene Typen (z. B. Zink-Kohle-Batterien und Alkalibatterien) zu mischen.
- Vermeiden Sie es, dass Metallgegenstände die Batteriepole berühren, um Verbrennungen zu vermeiden.
- Tauchen Sie Batterien nicht in Wasser ein und setzen Sie sie nicht dem Feuer aus.
- Verwenden Sie keine nassen Batterien und versuchen Sie nicht, sie mit Wärmequellen wie Haartrocknern oder Öfen zu trocknen.
- Behandeln Sie Batterien vorsichtig, um physische Schäden oder Kurzschlüsse zu vermeiden.
- Entsorgen Sie beschädigte Batterien sicher.

WARNUNG: Sicherheit für nicht vom Benutzer austauschbare Akkus

Der unsachgemäße Umgang mit der nicht austauschbaren Batterie Ihres Geräts kann zu einem Brand oder einer Explosion führen:

- Erhitzen Sie das Gerät oder den Akku nicht, öffnen Sie ihn nicht, durchstechen Sie ihn nicht und entsorgen Sie ihn nicht im Feuer.

Recycling Information

- Vermeiden Sie es, das Gerät über einen längeren Zeitraum in direktem Sonnenlicht aufzuladen. Wenden Sie sich für Reparaturen an Fachleute. Reparaturversuche können zu Stromschlägen, Geräteschäden oder Verletzungen führen.

WARNUNG: Sicherheit bei vom Benutzer austauschbaren Batterien

Wenn Ihr Gerät über eine vom Benutzer austauschbare Batterie verfügt:

- Befolgen Sie die Anweisungen in der Schnellstartanleitung, um die Batterie zu ersetzen.
- Wenden Sie sich bei anderen Reparaturen an einen Fachmann, um Risiken wie Stromschlag oder Geräteschäden zu vermeiden.

WARNUNG: Sicherheit bei Knopfzellen-/Knopfbatterien

VERÄTZUNGSGEFAHR. AUSSERHALB DER REICHWEITE VON KINDERN AUFBEWAHREN.

Das Verschlucken von Knopfzellen-/Knopfbatterien kann innerhalb weniger Stunden zu schweren inneren Verletzungen oder zum Tod führen. Suchen Sie bei Verdacht auf Verschlucken oder Einstecken sofort einen Arzt auf. Bewahren Sie neue und gebrauchte Batterien immer außerhalb der Reichweite von Kindern auf.

VORSICHT: Batterien können explodieren oder auslaufen und Verbrennungen verursachen, wenn sie unsachgemäß aufgeladen, ins Feuer geworfen, mit anderen Batterietypen gemischt oder verkehrt herum eingelegt werden. Ersetzen Sie alle Batterien zur gleichen Zeit. Tragen Sie keine losen Batterien bei sich und entfernen Sie keine Batterieetiketten.

ERSTE-HILFE-INFORMATIONEN

Verschlucken: Kein Erbrechen herbeiführen. Sofort ärztliche Hilfe in Anspruch nehmen.

Augenkontakt: 15 Minuten lang mit Wasser spülen und bei anhaltender Reizung ärztliche Hilfe in Anspruch nehmen.

Hautkontakt: Mit Wasser und Seife waschen. Bei anhaltender Reizung ärztliche Hilfe in Anspruch nehmen.

Einatmen: An die frische Luft bringen. Bei anhaltenden Symptomen ärztlichen Rat einholen.

MASSNAHMEN ZUR BRANDBEKÄMPFUNG

Gefahren bei Verbrennung: Batterien können giftige Dämpfe wie Kohlenmonoxid und andere Schadstoffe freisetzen. Einatmen vermeiden.

Feuerlöschmittel: Verwenden Sie bei Batteriebränden Feuerlöscher der Klasse „D“, Lith-x, Kupferpulver oder trockenen Sand. Bei benachbarten Bränden von verpackten Zellen kann Wasser oder CO₂ verwendet werden. Vermeiden Sie Wasser für unverpackte Zellen.

Die Feuerwehrleute sollten umluftunabhängige Atemschutzgeräte tragen.

HANDHABUNG UND LAGERUNG

Vorsichtsmaßnahmen: Behandeln Sie Batterien vorsichtig, um Schäden zu vermeiden, die zu Kurzschlüssen, Auslaufen oder Explosionen führen könnten.

Lagerung: Bewahren Sie die Batterien in einem kühlen, trockenen und gut belüfteten Bereich auf.

ANWEISUNGEN für die Verwendung, das Entfernen und das Ersetzen von Batterien

Lesen Sie die technischen Daten vor dem Gebrauch sorgfältig durch. Unsachgemäßer Umgang mit Lithiumbatterien kann zu Fehlfunktionen wie Auslaufen, Überhitzung, Brand oder Explosion führen. Befolgen Sie alle Anweisungen zur sicheren Verwendung, Entnahme und zum Austausch der Batterien, um Verletzungen oder Geräteschäden zu vermeiden.

Angaben zur sicheren Entnahme der Batterien oder der Akkumulatoren

Die (wiederaufladbare) Batterie kann dem Gerät nicht entnommen werden. Stellen Sie sicher, dass sie entladen ist bevor Sie das Gerät dem Sammelsystem für Elektroaltgeräte zuführen.

4. Möglichkeiten der Rückgabe von Altgeräten

Besitzer von Altgeräten aus privaten Haushalten können diese bei den Sammelstellen der öffentlich-rechtlichen Entsorgungsträger oder bei den von Herstellern oder Vertreibern im Sinne des ElektroG eingerichteten Rücknahmestellen unentgeltlich abgeben.

Rücknahmepflichtig sind Geschäfte mit einer Verkaufsfläche von mindestens 400 m² für Elektro- und Elektronikgeräte sowie diejenigen Lebensmittelgeschäfte mit einer Gesamtverkaufsfläche von mindestens 800 m², die mehrmals pro Jahr oder dauerhaft Elektro- und Elektronikgeräte anbieten und auf dem Markt bereitstellen. Dies gilt auch bei Vertrieb unter Verwendung von Fernkommunikationsmitteln, wenn die Lager- und Versandflächen für Elektro- und Elektronikgeräte mindestens 400 m² betragen oder die gesamten Lager- und Versandflächen mindestens 800m² betragen. Vertreter haben die Rücknahme grundsätzlich durch geeignete Rückgabemöglichkeiten in zumutbarer Entfernung zum jeweiligen Endnutzer zu gewährleisten.

Die Möglichkeit der unentgeltlichen Rückgabe eines Altgerätes besteht bei rücknahmepflichtigen Vertreibern unter anderem dann, wenn ein neues gleichartiges Gerät, das im Wesentlichen die gleichen Funktionen erfüllt, an einen

Recycling Information

Endnutzer abgegeben wird. Wenn ein neues Gerät an einen privaten Haushalt ausgeliefert wird, kann das gleichartige Altgerät auch dort zur unentgeltlichen Abholung übergeben werden; dies gilt bei einem Vertrieb unter Verwendung von Fernkommunikationsmitteln für Geräte der Kategorien 1, 2 oder 4 gemäß § 2 Abs. 1 ElektroG, nämlich „Wärmeüberträger“, „Bildschirmgeräte“ oder „Großgeräte“ (letztere mit mindestens einer äußeren Abmessung über 50 Zentimeter). Zu einer entsprechenden Rückgabe-Absicht werden Endnutzer beim Abschluss eines Kaufvertrages befragt. Außerdem besteht die Möglichkeit der unentgeltlichen Rückgabe bei Sammelstellen der Vertreiber unabhängig vom Kauf eines neuen Gerätes für solche Altgeräte, die in keiner äußeren Abmessung größer als 25 Zentimeter sind, und zwar beschränkt auf drei Altgeräte pro Geräteart.

5. Datenschutz-Hinweis

Altgeräte enthalten häufig sensible personenbezogene Daten. Dies gilt insbesondere für Geräte der Informations- und Telekommunikationstechnik wie Computer und Smartphones. Bitte beachten Sie in Ihrem eigenen Interesse, dass für die Löschung der Daten auf den zu entsorgenden Altgeräten jeder Endnutzer selbst verantwortlich ist.

France

En 2006, l'union Européenne a introduit la nouvelle réglementation (DEEE) pour le recyclage de tout équipement électrique et électronique. Chaque Etat membre de l'Union Européenne a mis en application la nouvelle réglementation DEEE de manières légèrement différentes. Veuillez suivre le décret d'application correspondant à l'élimination des déchets électriques ou électroniques de votre pays.

Italy

Nel 2006 l'unione europea ha introdotto regolamentazioni (WEEE) per la raccolta e il riciclo di apparecchi elettrici ed elettronici. Non è più consentito semplicemente gettare queste apparecchiature, devono essere riciclate. Ogni stato membro dell'EU ha tramutato le direttive WEEE in leggi statali in varie misure. Fare riferimento alle leggi del proprio Stato quando si dispone di un apparecchio elettrico o elettronico. Per ulteriori dettagli fare riferimento alla direttiva WEEE sul riciclaggio del proprio Stato.

España

En 2006, la Unión Europea introdujo regulaciones (WEEE) para la recolección y reciclaje de todos los residuos de aparatos eléctricos y electrónicos. Ya no está permitido simplemente tirar los equipos eléctricos y electrónicos. En cambio, estos productos deben entrar en el proceso de reciclaje. Cada estado miembro de la UE ha implementado las regulaciones de WEEE en la legislación nacional de manera ligeramente diferente. Por favor, siga su legislación nacional cuando desee deshacerse de cualquier producto eléctrico o electrónico. Se pueden obtener más detalles en su agencia nacional de reciclaje de WEEE.

Polska

W 2006 roku Unia Europejska wprowadziła przepisy (WEEE) dotyczące zbierania i recyklingu wszystkich zużytych urządzeń elektrycznych i elektronicznych. Nie można już po prostu wyrzucać sprzętu elektrycznego i elektronicznego. Zamiast tego produkty te muszą zostać wprowadzone do procesu recyklingu. Każde państwo członkowskie UE, a także Wielka Brytania, wdrożyły przepisy DOTYCZĄCE WEEE do prawa krajowego w nieco inny sposób. Przestrzegaj prawa krajowego, gdy chcesz pozbyć się jakichkolwiek produktów elektrycznych lub elektronicznych. Więcej szczegółów można uzyskać w krajowej agencji recyklingu WEEE.

CE/FCC Statement

CE Certification

LINDY declares that this equipment complies with relevant European CE requirements.

CE Konformitätserklärung

LINDY erklärt, dass dieses Equipment den europäischen CE-Anforderungen entspricht

UKCA Certification

LINDY declares that this equipment complies with relevant UKCA requirements.

FCC Certification

This equipment has been tested and found to comply with the limits for a Class B digital device, pursuant to part 15 of the FCC Rules. These limits are designed to provide reasonable protection against harmful interference in a residential installation.

You are cautioned that changes or modification not expressly approved by the party responsible for compliance could void your authority to operate the equipment.

This device complies with part 15 of the FCC Rules.

Operation is subject to the following two conditions:

1. This device may not cause harmful interference, and
2. This device must accept any interference received, including interference that may cause undesired operation.

The enclosed power supply has passed Safety test requirements, conforming to the US American versions of the international Standard IEC 62368-1.

LINDY Herstellergarantie – Hinweis für Kunden in Deutschland

LINDY gewährt für dieses Produkt über die gesetzliche Regelung in Deutschland hinaus eine zweijährige Herstellergarantie ab Kaufdatum. Die detaillierten Bedingungen dieser Garantie finden Sie auf der LINDY Website aufgelistet bei den AGBs.

Statement of PSTI Compliance

This product has been designed in conformance with the applicable security requirements of the following UK Legislation: Product Security and Telecommunications Infrastructure Act 2022 and Schedule 1 of The Product Security and Telecommunications Infrastructure (Security Requirements for Relevant Connectable Products) Regulations 2023.

The product is in conformity with the following Security requirements:

1. Password is unique per device or defined by the user of the device, and the password which is unique per device is generated by using as security mechanism that reduces the risk of automated attacks against a class or type of device.
2. Users can report vulnerabilities to LINDY via productsecurity@lindy.co.uk, furthermore, users will receive acknowledgment of the receipt of a security issues report and status updates until the resolution of the reported security issues.
3. We will provide security updates and patches to address any security vulnerabilities that may be identified in the product during the support period. The defined support period will end on May 2030 after the product's last end-of-life date.

Hersteller / Manufacturer (EU):

LINDY-Elektronik GmbH
Markircher Str. 20
68229 Mannheim
Germany
Email: info@lindy.com, T: +49 (0)621 470050

Manufacturer (UK):

LINDY Electronics Ltd
Sadler Forster Way
Stockton-on-Tees, TS17 9JY
England
sales@lindy.co.uk, T: +44 (0)1642 754000



Tested to comply with
FCC standards.
For home and office use.

No.32622
1st Edition, May 2025
lindy.com



Save the Environment: Please Avoid Printing

In our commitment to sustainability, we encourage you to save paper and reduce waste. Please consider whether it is absolutely necessary to print this document. Instead, we suggest saving it digitally or sharing it via email to reduce environmental impact. Together, we can contribute to a greener future. Thank you for your support.